

HOBOT

HOBOT-168 Glass Cleaning Robot

User's Manual



Copyright

Copyright © 2012 by HOBOT® Technology Inc. All rights reserved. No part of this publication may be reproduced, transmitted, transcribed, stored in a retrieval system or translated into any language or computer language, in any form or by any means, electronic, mechanical, magnetic, optical, chemical, manual or otherwise, without the prior written permission of this company.

Trademarks

All other logos, products, or company names mentioned in this manual may be the registered trademarks or copyrights of their respective companies, and are used for informational purposes only.

Technical support

If any problems occur and manual cannot provide the solution you need. Please contact the local retailers or the local authorized dealers.

Disclaimer

HOBOT Technology Inc. makes no representations or warranties, either expressed or implied, with respect to the contents hereof and specifically disclaims any warranties, merchantability, or fitness for any particular purpose. Further, HOBOT Technology Inc. reserves the right to revise this publication and to make changes from time to time in the contents hereof without obligation of this company to notify and person of such revision or changes.

The place and safety of this glass cleaning tool usage must be judged and responsible by user. But also need to follow the instructions in this user manual.

Important Safety Precautions

Read all instructions before operating the device

WARNING

1. Fasten the safety rope and tie to indoor fixture before operating the device.
2. Check if the safety rope is broken or the knot is loose before operating the device.
3. Set danger-warning area downstairs for no-balcony window and door.
4. Battery shall be full-charged (green lamp ON) before using.
5. Do not use it in rainy or moist day.
6. Turn power on before put device onto glass.
7. Make sure appliance can stick and stand on glass surface while put onto glass.
8. Before turn power off, please hold device.
9. Do not use it on frameless glass.
10. Make sure put cleaning ring onto cleaning wheel correctly for no leakage.
11. Do not spray or pour water onto the appliance.
12. Prohibit children from using this device.
13. Remove anything on the glass. Do not use on cracked glass. Reflective or coating glass might be slightly scratched due to dirt on the glass while operating.
14. Keep hair, loose clothing, fingers, and all parts of body away from the openings and moving parts.
15. Do not use in areas with existed flammable or combustible liquids, gas.

Product introduction

HOBOT-168 is a glass-cleaning robot, with a vacuum motor inside that can suck air and stand on the glass surface. An embedded UPS (Un-interrupted Power System) can prevent the robot falling from the window even when no electrical power.

HOBOT has two special-design cleaning wheels that can freely traverse on the window surface and even on the wall. The easy replaceable lint free cloth is used on both of the cleaning wheels. Micro-fiber based cloth is used for good glass cleaning.

HOBOT has AI-Technology that can calculate path, auto-detect fringe of window, auto-clean entire window. Also has manual mode for user operation.

Product and accessories

- Device x 1
- Remote controller x 1
- Adapter (100~240VAC, 50~60Hz) x 1
- AC power cord x 1
- DC power extension cable (4 meter) x 1
- Cleaning cloth x 12
- Cleaning ring x 4
- User manual x 1

Product features

- For any kind thickness glass
- AI Technology
- Cleaning speed: 4 minutes/meter².
- 3 kinds of automatic operation modes for cleaning entire window
- Auto-finish.
- Embedded UPS (Un-interrupted Power System)
- Anti-dropping control algorithm
- Auto detect edges of window
- Micro-fiber cloth
- High strength safety rope (150Kgf)
- Remote control
- Table cleaning mode
- Power consumption : 80W
- Input voltage: 100~240VAC, 50~60Hz

Getting to know the device

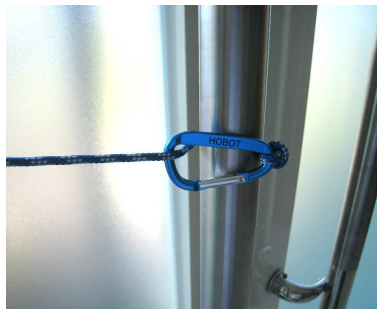
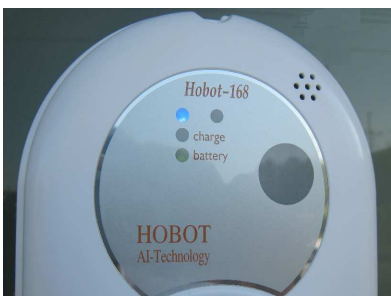
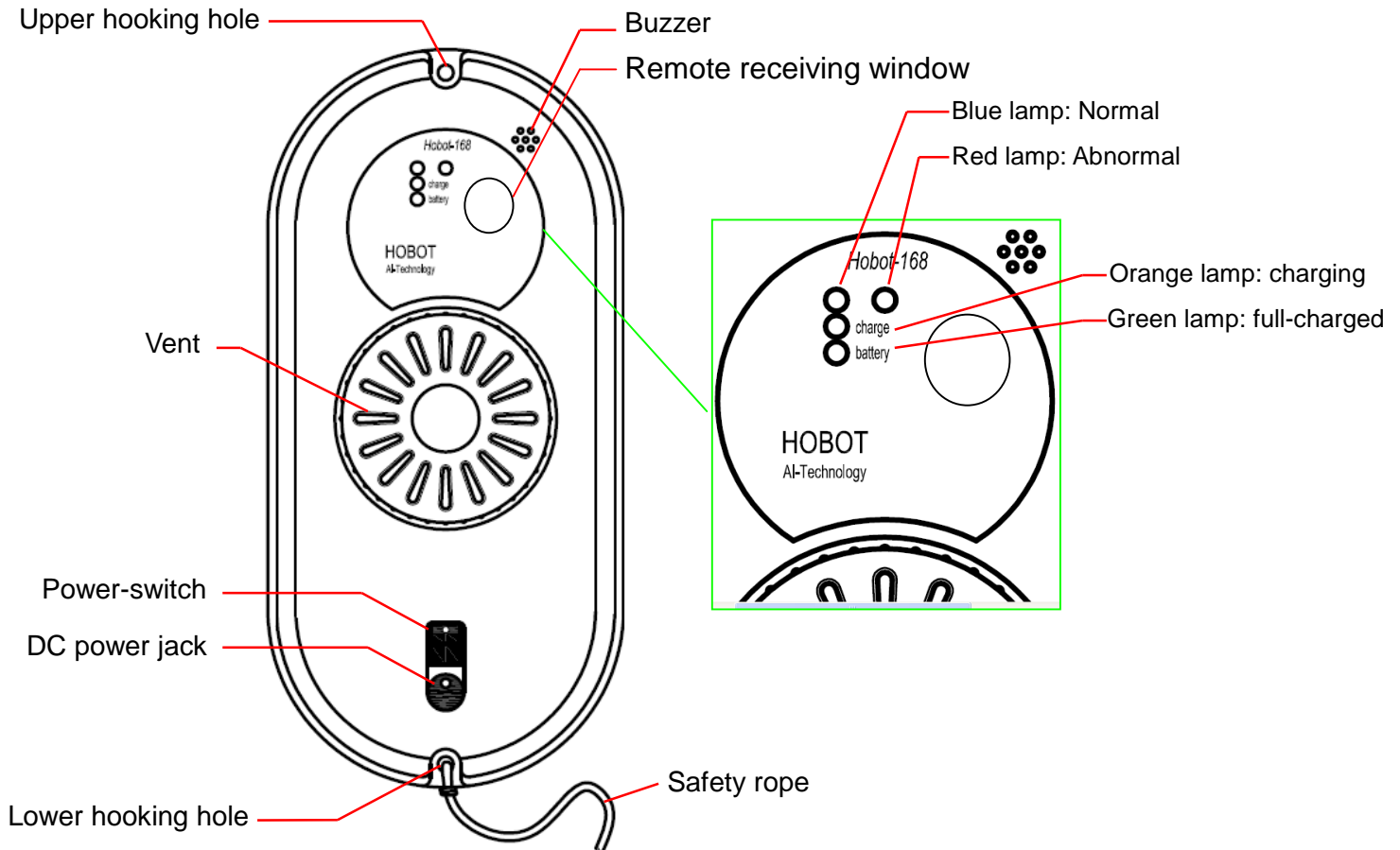

- HOBOT-168 shall always connect power cable for normal using.
- How to put device onto glass to start using
 - (1) Turn on power-switch, and then make sure the fan is running.
 - (2) Put device onto glass.
 - (3) Check if device can stick to the glass before releasing it.
- How to take device down from glass
 - (1) While device is running, please hold safety rope with one hand and take device

down from glass with the other hand.

(2) Turn off power-switch in safe area.

- Safety rope and buckle

(1) Before using, check if the safety rope is broken or the knot is loose.

(2) Fasten the safety rope and tie to indoor fixture before operating.

- UPS (Un-interrupted Power System) function

(1) The UPS function will be enabled automatically when no electric power supplied. The backup time of this UPS is 30 minutes.

(2) If no electric power is supplied, the device will stop automatically, alert and flash red lamp. User shall take device down from the glass as soon as possible.

(3) User can pull device back by pulling safety rope. Slightly pull the safety rope at an angle close to the glass to prevent dropping.

- Please make sure the battery was full-charged (green lamp ON) before using.

(1) First, turn off the power-switch on the device. Plug in the power. Orange lamp ON means charging.

(2) Green lamp ON means the battery was full-charged.

- Table cleaning mode

Put device on the table and select auto-cleaning mode, the device will run in table-cleaning mode.

- Notice

(1) Do not use it on frameless glass.

(2) Make sure put cleaning ring onto cleaning wheel correctly for no leakage.

(3) Do not use it in rainy or moist day.

(4) Set danger-warning area downstairs for no-balcony window and door.

How to clean the glass

Step I: Use clean-and-dry cleaning cloth to clean dust and sand on the glass.

Step II: Change again the cleaning cloth. Keep upper wheel's cleaning cloth as clean-and-dry. Spray a little detergent (1~2 spray) on lower wheel's cleaning cloth, but not make cloth wet (if too wet, machine can't move well). Then clean the glass again.

Remote controller

The device can be remote controlled from the front and backside.

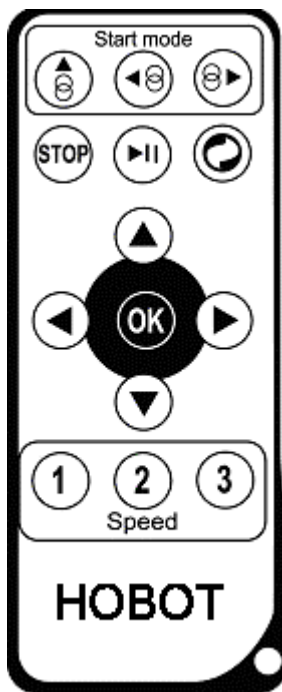

	Auto Up then Down		Manual Up
	Auto Left then Down		Manual Down
	Auto Right then Down		Manual Right
1	No Use		Manual Left
2	No Use	OK	Stop
3	No Use		No Use
STOP	Stop		

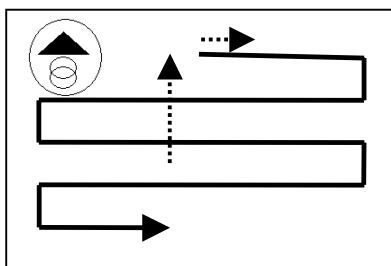

Auto Up then Down

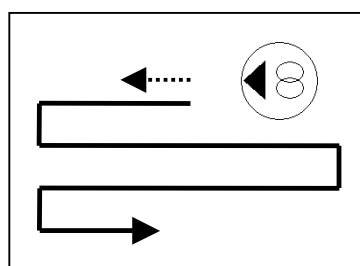

Auto Left then Down

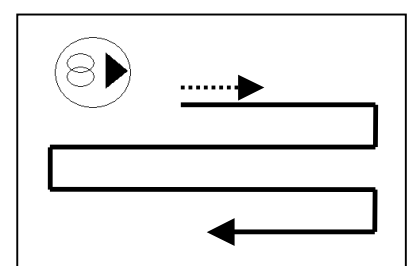

Auto Right then Down

※ Please remove the insulation spacer in the bottom of back of remote controller before using. If you have to replace the battery, just pull down the battery cover.

Power adapter/DC extension cable

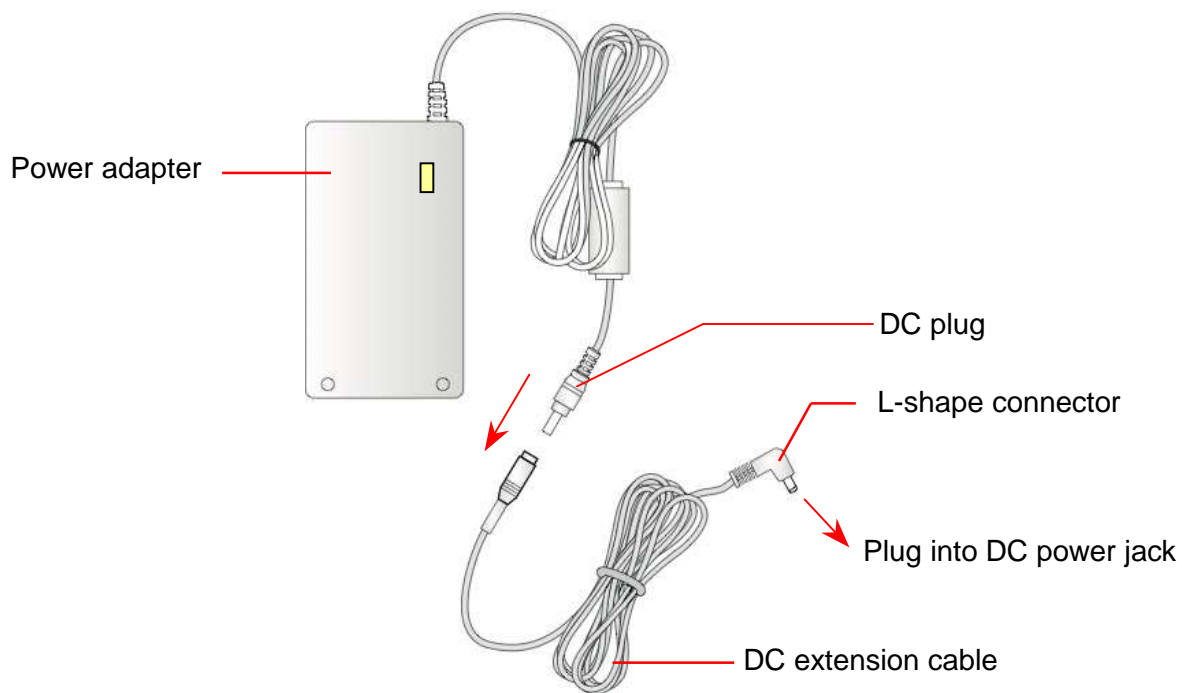

Using the cleaning ring and the cleaning cloth

1. Cover cleaning ring with cleaning cloth.

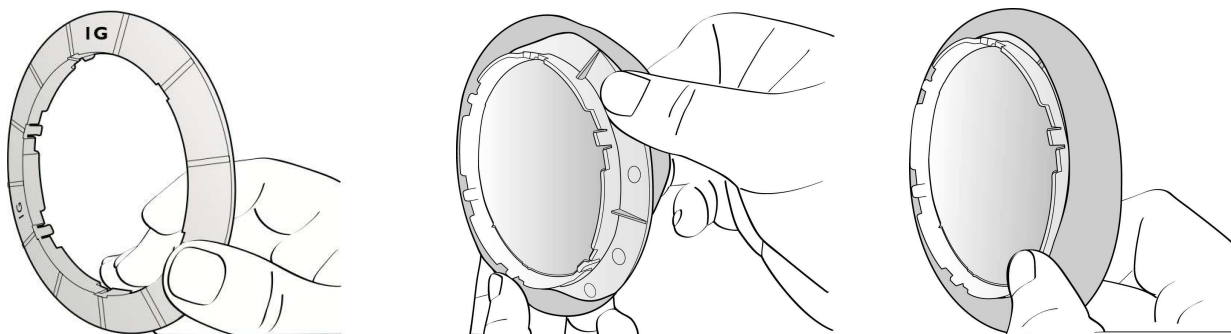

2. Put cleaning ring onto cleaning wheel correctly (luck 6 claws) for no leakage.



Frequently asked questions (FAQ)

Q1: If HOBOT can't startup and alert at the beginning of self-test.

Ans: It means that the friction factor is not properly used. Please check:

- (1) Whether the cleaning cloth is too dirty.
- (2) Glass stickers, window film on the glass will also affect the friction factor.
- (3) If clean window many times, the glass surface will become very slippery.
- (4) The glass surface will become slippery if clean several times in low humidity environment such as in air-conditioned room.

Q2: HOBOT slips and cannot detect the upper frame of window in "Auto Up then Down" () mode.

Ans: Press  key and switch to  or  auto mode.

Q3: HOBOT cannot finish whole window and stop at middle area.

Ans: Press  or  auto mode to continue cleaning.

Q4: HOBOT slips and cannot get higher to the window frame.

Ans: (1) Friction factor is too low that might be caused by glass stickers, window film on the glass.
(2) Cleaning cloth might be too wet.
(3) If clean window many times, the glass surface will become very slippery.
(4) The glass surface will become slippery if clean several times in low humidity environment such as in air-conditioned room.

Q5: HOBOT does not move smoothly or move irregularly.

Ans: (1) Cleaning cloth is too dirty. Please change a clean-cleaning cloth.
(2) Glass surface has different friction factor areas due to stickers, window film, and so on. Please use HOBOT in single area.
(3) The screw of cleaning wheel might be get loose, just tighten it.

Q6: After cleaning, remained circle mark on the glass surface.

Ans: Cleaning cloth is too dirty. Please change a clean-cleaning cloth and clean again.

Q7: What to do if HOBOT stopped at higher area while no electric power supplied, HOBOT alarm and red lamp is flashing?

Ans: (1) User can pull HOBOT back with safety rope. Slightly pull the safety rope at

an angle close to the glass to prevent dropping.

(2) Switch the power-switch to “off”

(3) Check out whether electric poor-contact, cable broken or not.

Q8: What to do if HOBOT abnormally stopped and red lamp is flashing, without alarm?

Ans:(1) User can move HOBOT to safe area by remote control, or pull HOBOT back with safety rope. Slightly pull the safety rope at an angle close to the glass to prevent dropping.

(2) Switch the power-switch to “off”

(3) Check whether there is air-leakage caused by gap, uneven window frame.

Q9: When turn on power switch, the FAN do not rotating, and no alarm.

Case	LED signal	Situation
1	Blue: flash Orange: on Red: off No alarm	It means battery voltage too low, please waiting for battery full-charged (Green lamp on). If machine still can't be use after charge 8 hours, the battery shall be change.
2	Blue: flash Red: flash No alarm	Machine hardware failure. Please contact the local retailers or local authorized dealers for repair.

Safety information about power adapter/battery

- Use only the power adapter supplied with this device. Use of other type of power adapter will result in malfunction and/or danger.
- Please use the proper electric outlet and make sure no heavy objects are placed on the power adapter or power cord.
- Allow adequate ventilation around the adapter when using it to operate the device. Do not cover the power adapter with objects that will reduce cooling.
- Do not use the adapter in a high moisture environment. Never handle the adapter with wet hands.
- Connect the adapter to a proper power source. The voltage requirements are found on the adapter.
- Do not use broken adapter, power cord or plug.
- Do not attempt to service the adapter. There are no service parts inside. Replace the whole unit if it is damaged or exposed to high moisture. Consult your HOBOT

dealer for help and maintenance.

- The battery used in this device may present a risk of fire or chemical burn if mistreated. Do not disassemble, short contacts, heat above 60°C (140°F), or incinerate.
- If you have to dispose of this old equipment, please take it to the local recycling center for recycling electrical and electronic parts.

EC Declaration of Conformity

EC Declaration of Conformity

THIS IS HEREBY DECLARED THAT FOLLOWING DESIGNATED PRODUCT COMPLIED WITH THE ESSENTIAL HEALTH AND SAFETY REQUIREMENTS OF MACHINE DIRECTIVE 2006/42/EC AND ELECTROMAGNETIC COMPATIBILITY 2004/108/EC ON THE APPROXIMATION OF THE LAWS OF THE MEMBER STATES RELATING TO IT.

Manufacturer: HOBOT Technology Inc. AIKO 2 ND ROAD, HSINCHU, TAIWAN, R.O.C.
Name and address of person authorized to compile the technical file Name: Address:
Description of Machinery Product Name: GLASS CLEANING ROBOT Model No.: HOBOT-168
Applicable Standards EMC: EN 55014-1:2006 EN 55014-2: 1997+A1:2001 EN 61000-3-2: 2006+A2: 2009 IEC 61000-4-2: 2008 EN 61000-3-3: 2008 IEC 61000-4-3: 2010 IEC 61000-4-4: 2012 IEC 61000-4-5: 2005 IEC 61000-4-6: 2008 IEC 61000-4-11: 2004 Low Voltage Directive (2006/95/EC): IEC 60950-1:2005 EN 60950-1:2006+A11:2009 ErP Directive: Lot 7(278/2009) of (2009/125/EC)

THIS DECLARATION APPLIES TO ALL SPECIMENS MANUFACTURED IDENTICAL TO THE MODEL SUBMITTED FOR TESTING / EVALUATION. ASSESSMENT OF COMPLIANCE OF THE PRODUCT WITH THE REQUIREMENTS RELATING TO SAFETY STANDARDS LISTED ABOVE WAS PERFORMED BY MANUFACTURE.

 **SIGN ON BEHALF OF HOBOT TECHNOLOGY INC.**

Signature: _____
Title: General Manager
Place: Hsinchu
Date: 2012.11.29

General safety information

- Retain the safety and operating instructions for future reference.
- Follow all operating and use instructions.
- Do not expose your device to rain or excess humidity, and keep it away from liquids (such as beverages, faucets, and so on).
- Avoid exposing your device to direct sunlight or intense light source, and keep it away from heat source (such as radiators, space heaters, stoves, and so on).
- Do not place the device in the vicinity of strong magnetic fields.
- Keep the device and accessories away from children.
- Product operating temperature: 0°C ~40°C (32°F ~104°F) ◦
- Product storage temperature: -10°C ~50°C (14°F ~122°F) ◦

Limited warranty

If there are defects in your HOBOT glass-cleaning robot due to faulty materials, workmanship or function within warranty period from the date of purchase or delivery, please contact the local retailers or local authorized dealers for repair or replacement.

Non-warranty

- Normal wear and tear (e.g. cleaning cloth, safety rope, etc).
- Reduction in battery discharge time due to battery age or use.
- Damage caused by assembling or installing that not in accordance with the instructions of HOBOT.
- Damage caused by using the HOBOT glass-cleaning robot for any other purposes than normal domestic household.
- Damage caused by using parts and accessories which are not specified by HOBOT.
- Damage caused by accident, abuse or misuse.

