

User's Guide



Guide to the Scanner Parts

Check this section to identify the parts of your scanner.



Scanning Your Originals

Follow the step-by-step instructions here to scan your original documents or photos using any of the available scanning methods.



Maintenance

Follow the guidelines here to maintain and transport your scanner.



Technical Specifications

Check here for technical details about your scanner and its accessories.



Placing Originals on the Scanner

Follow the steps here to place your original documents or photos on the scanner.



Scanning Special Projects

Follow the instructions here for specific scanning projects you may need to create.



Solving Problems

If you have a problem using your scanner or its software, check here for solutions.

- [Safety](#)
- [Copyright and Trademarks](#)
- [Operating System Versions](#)

[Home](#) > [Guide to the Scanner Parts](#)

Guide to the Scanner Parts

Check these sections to identify the parts of your scanner.

 [Scanner Parts](#)

 [Light and Buttons](#)

[Home](#) > [Placing Originals on the Scanner](#)

Placing Originals on the Scanner

Follow the steps here to place your original documents or photos on the scanner.

 [Placing Documents or Photos](#)

 [Placing Film or Slides \(EPSON Perfection V370 Photo Only\)](#)

[Home](#) > [Scanning Your Originals](#)

Scanning Your Originals

Follow the step-by-step instructions here to scan your original documents or photos using any of the available scanning methods.

 [Using the Scanner Buttons](#)

 [Using Document Capture Pro \(for Windows\)/Document Capture \(for Mac OS X\)](#)

 [Using Another Scanning Program](#)

 [EPSON Scan Mode](#)

[Home](#) > Scanning Special Projects

Scanning Special Projects

Follow these instructions for specific scanning projects you may need to create.

 [Scanning to SharePoint or Cloud Service](#)

 [Scanning to a PDF File](#)

 [Using the Scanner as a Copier](#)

 [Scanning Directly to an E-mail](#)

 [Assigning a Program to a Scanner Button](#)

 [Converting Scanned Documents Into Editable Text](#)

 [Adjusting the Scanned Image](#)

[Home](#) > Maintenance

Maintenance

Follow the guidelines here to maintain and transport your scanner.

 [Cleaning the Scanner](#)

 [Transporting the Scanner](#)

 [Power Off Timer Setting](#)

[Home](#) > Solving Problems

Solving Problems

Troubleshooting

If you have a problem using your scanner or its software, check here for solutions.

 [Scanner Problems](#)

 [Scanning Problems](#)

 [Scan Quality Problems](#)

 [Uninstalling Your Scanning Software](#)

Where To Get Help

 [Epson Technical Support](#)

 [Other Software Technical Support](#)

Home > Technical Specifications

Technical Specifications

Check here for technical details about your scanner and its accessories.

 **System Requirements**

 **Scanner Specifications**

 **Note:**

Epson offers a recycling program for end of life products. Please go to www.epson.com/recycle for information on how to return your products for proper disposal.

[Home](#) > [Safety](#)

Important Safety Instructions

[Restrictions on Copying](#)

In this document, warnings, cautions, and notes indicate the following:

Warnings

must be followed carefully to avoid bodily injury.

Cautions

must be observed to avoid damage to your equipment.

Notes

contain important information and useful tips on the operation of this product.

Read all these instructions, and follow all warnings and instructions marked on the scanner.

- Place the scanner close enough to the computer for the interface cable to reach it easily. Do not place or store the scanner or the AC adapter outdoors, near excessive dirt or dust, water, heat sources, or in locations subject to shocks, vibrations, high temperature or humidity, direct sunlight, strong light sources, or rapid changes in temperature or humidity. Do not use with wet hands.
- Place the scanner and the AC adapter near an electrical outlet where the adapter can be easily unplugged.

Caution:

Be sure the AC adapter meets the relevant local safety standards.

- The AC adapter cord should be placed to avoid abrasions, cuts, fraying, crimping, and kinking. Do not place objects on top of the cord and do not allow the AC adapter or the cord to be stepped on or run over. Be particularly careful to keep the cord straight at the end and the point where it enters the AC adapter.
- Use only the AC adapter that comes with your scanner. Using any other adapter could cause fire, electrical shock, or injury.
- The AC adapter is designed for use with the scanner with which it was included. Do not attempt to use it with other electronic devices unless specified.
- Use only the type of power source indicated on the AC adapter's label, and always supply power directly from a standard domestic electrical outlet with the AC adapter that meets the relevant local safety standards.
- When connecting this product to a computer or other device with a cable, ensure the correct orientation of the connectors. Each connector has only one correct orientation. Inserting a connector in the wrong orientation may damage both devices connected by the cable.
- Avoid using outlets on the same circuit as photocopiers or air control systems that regularly switch on and off.
- If you use an extension cord with the scanner, make sure the total ampere rating of the devices plugged into the extension cord does not exceed the cord's ampere rating. Also, make sure the total ampere rating of all devices plugged into the wall outlet does not exceed the wall outlet's ampere rating.

- Never disassemble, modify, or attempt to repair the AC adapter, scanner, or scanner option by yourself except as specifically explained in the scanner's guides.
- Do not insert objects into any opening as they may touch dangerous voltage points or short out parts. Beware of electrical shock hazards.
- If damage occurs to the plug, replace the cord set or consult a qualified electrician. If there are fuses in the plug, make sure you replace them with fuses of the correct size and rating.
- Unplug the scanner and the AC adapter, and refer servicing to qualified service personnel under the following conditions: The AC adapter or plug is damaged; liquid has entered the scanner or the AC adapter; the scanner or the AC adapter has been dropped or the case has been damaged; the scanner or the AC adapter does not operate normally or exhibits a distinct change in performance. (Do not adjust controls that are not covered by the operating instructions.)
- Unplug the scanner and the AC adapter before cleaning. Clean with a damp cloth only. Do not use liquid or aerosol cleaners.
- If you are not going to use the scanner for a long period, be sure to unplug the AC adapter from the electrical outlet.



WARNING:

The cords included with this product contain chemicals, including lead, known to the State of California to cause birth defects or other reproductive harm. ***Wash hands after handling.*** (This notice is provided in accordance with Proposition 65 in Cal. Health & Safety Code § 25249.5 and following.)

Restrictions on Copying

Observe the following restrictions to ensure responsible and legal use of your scanner.

Copying of the following items is prohibited by law:

- Bank bills, coins, government-issued marketable securities, government bond securities, and municipal securities
- Unused postage stamps, pre-stamped postcards, and other official postal items bearing valid postage
- Government-issued revenue stamps, and securities issued according to legal procedure

Exercise caution when copying the following items:

- Private marketable securities (stock certificates, negotiable notes, checks, etc.), monthly passes, concession tickets, etc.
- Passports, driver's licenses, warrants of fitness, road passes, food stamps, tickets, etc.



Note:

Copying these items may also be prohibited by law.

A note concerning responsible use of copyrighted materials

Epson encourages each user to be responsible and respectful of the copyright laws when using any EPSON product. While some countries' laws permit limited copying or reuse of copyrighted material in certain circumstances, those circumstances may not be as broad as some people assume. Contact your legal advisor for any questions regarding copyright law.

Default Delay Times for Power Management for EPSON Products

This product will enter sleep mode after a period of nonuse. The time interval has been set at the factory to ensure that the product meets Energy Star Standards of energy efficiency, and cannot be modified by the consumer.

Restriction on disassembling and decompiling

You may not disassemble, decompile or otherwise attempt to derive the source code of any software included with this product.

[Home](#) > Copyright and Trademarks

■ Copyright and Trademarks

No part of this publication may be reproduced, stored in a retrieval system, or transmitted in any form or by any means, electronic, mechanical, photocopying, recording, or otherwise, without the prior written permission of Seiko Epson Corporation. No patent liability is assumed with respect to the use of the information contained herein. Neither is any liability assumed for damages resulting from the use of the information contained herein.

Neither Seiko Epson Corporation nor its affiliates shall be liable to the purchaser of this product or third parties for damages, losses, costs, or expenses incurred by the purchaser or third parties as a result of: accident, misuse, or abuse of this product or unauthorized modifications, repairs, or alterations to this product.

Seiko Epson Corporation and its affiliates shall not be liable against any damages or problems arising from the use of any options or any consumable products other than those designated as Original Epson Products or Epson Approved Products by Seiko Epson Corporation.

EPSON® and Perfection® are registered trademarks and EPSON Exceed Your Vision® is a registered logomark of Seiko Epson Corporation. Micro Step Drive is a trademark of Epson America, Inc.

Microsoft®, Windows®, and Windows Vista® are registered trademarks of Microsoft Corporation.

Adobe®, Adobe Reader®, Acrobat®, and Photoshop® are registered trademarks of Adobe Systems Incorporated.

Apple®, ColorSync®, and Macintosh® and Mac OS® are registered trademarks of Apple Inc.

ABBYY® and ABBYY FineReader® names and logos are registered trademarks of ABBYY Software House.

MediaImpression® is a registered trademark, and Scan-n-Stitch Deluxe™ is a trademark of ArcSoft Incorporated.

PRINT Image Matching™ and the PRINT Image Matching logo are trademarks of Seiko Epson Corporation.

Intel® is a registered trademark of Intel Corporation.

PowerPC® is a registered trademark of International Business Machines Corporation.

EPSON Scan Software is based in part on the work of the Independent JPEG Group.

libtiff

Copyright © 1988-1997 Sam Leffler

Copyright © 1991-1997 Silicon Graphics, Inc.

Permission to use, copy, modify, distribute, and sell this software and its documentation for any purpose is hereby granted without fee, provided that (i) the above copyright notices and this permission notice appear in all copies of the software and related documentation, and (ii) the names of Sam Leffler and Silicon Graphics may not be used in any advertising or publicity relating to the software without the specific, prior written permission of Sam Leffler and Silicon Graphics.

THE SOFTWARE IS PROVIDED "AS-IS" AND WITHOUT WARRANTY OF ANY KIND, EXPRESS, IMPLIED OR OTHERWISE, INCLUDING WITHOUT LIMITATION, ANY WARRANTY OF MERCHANTABILITY OR FITNESS FOR A PARTICULAR PURPOSE.

IN NO EVENT SHALL SAM LEFFLER OR SILICON GRAPHICS BE LIABLE FOR ANY SPECIAL, INCIDENTAL, INDIRECT OR CONSEQUENTIAL DAMAGES OF ANY KIND, OR ANY DAMAGES WHATSOEVER RESULTING FROM LOSS OF USE, DATA OR PROFITS, WHETHER OR NOT ADVISED OF THE POSSIBILITY OF DAMAGE, AND ON ANY THEORY OF LIABILITY, ARISING OUT OF OR IN CONNECTION WITH THE USE OR PERFORMANCE OF THIS SOFTWARE.

General Notice: Other product names used herein are for identification purposes only and may be trademarks of their respective owners. Epson disclaims any and all rights in those marks.

This information is subject to change without notice.

5/13

© 2013 Epson America, Inc.

[Home](#) > Operating System Versions

■ Operating System Versions

In this manual, the following abbreviations are used.

Windows refers to Windows 7, Vista, XP, and XP x64.

- Windows 7 refers to Windows 7 Home Basic, Windows 7 Home Premium, Windows 7 Professional, and Windows 7 Ultimate.
- Windows Vista refers to Windows Vista Home Basic Edition, Windows Vista Home Premium Edition, Windows Vista Business Edition, Windows Vista Enterprise Edition, and Windows Vista Ultimate Edition.
- Windows XP refers to Windows XP Home Edition, Windows XP Professional x64 Edition, and Windows XP Professional.

Macintosh refers to Mac OS X.

- Mac OS X refers to Mac OS X 10.5.8, 10.6.x, 10.7.x, or 10.8.x.

Scanner Parts

 **Note:**

The parts described in this section apply to EPSON Perfection V37 and EPSON Perfection V370 Photo scanners unless otherwise noted.

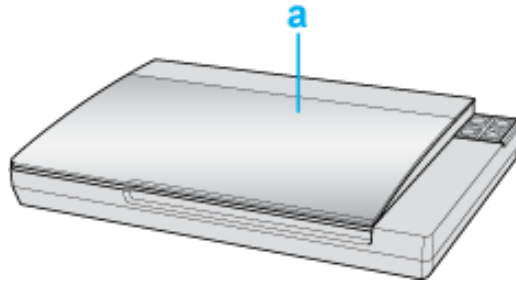

a. scanner cover

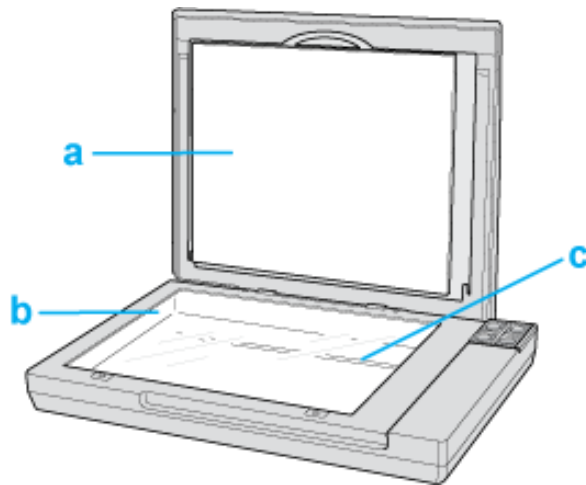

- a. document mat (EPSON Perfection V370 Photo only)
- b. document table
- c. carriage (in the document table)

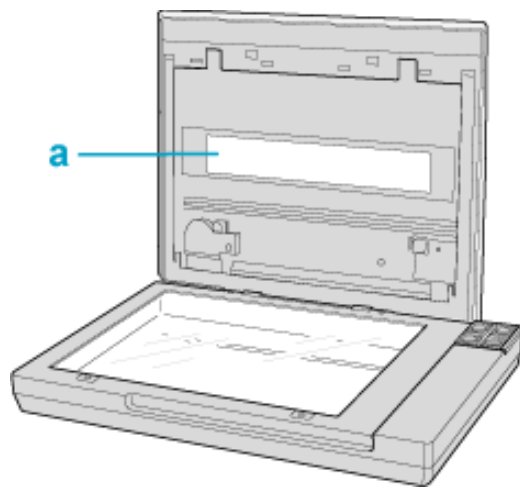

a. transparency unit window (EPSON Perfection V370 Photo only)

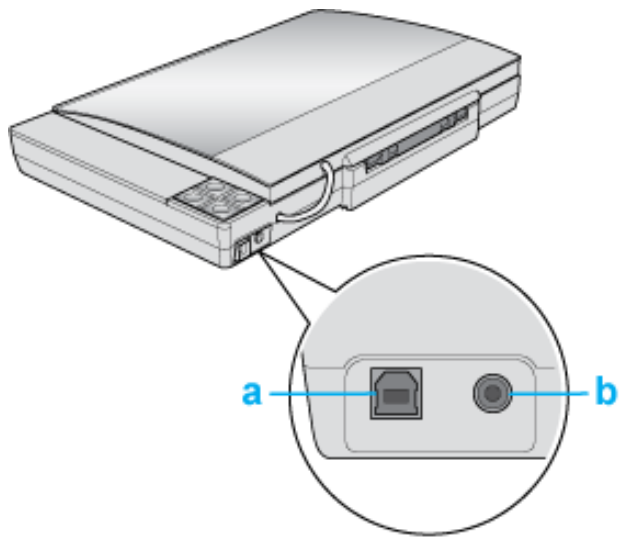

a. USB interface connector
b. DC inlet

Light and Buttons

Light

Buttons

The scanner has four buttons for scanning operations. The status light indicates whether the scanner is operating normally.

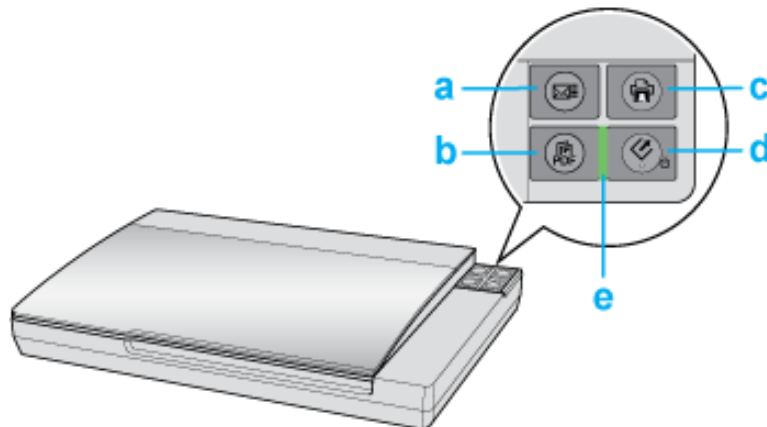

Note:

The illustration in this section is for the EPSON Perfection V370 Photo, but the descriptions also apply to the EPSON Perfection V37.

- a. Scan to E-mail button
- b. Scan to PDF button
- c. Copy button
- d. Power/Start button
- e. Status light

Light

The Status light is between the Power/Start button and the PDF button.







Color	Indicator Status	Meaning
Green	On	Ready to scan images.
	Flashing	Initializing or scanning.
Orange	Flashing	An error has occurred. See The Status Light Is Flashing for more information.

(None)	<input type="radio"/> Off	The scanner is off.
--------	---------------------------	---------------------

[Top](#) 

Buttons

Before using the scanner buttons, make sure you have installed EPSON Scan and EPSON Event Manager.

Button		Function
 Power /  Start	 Power	Turns the scanner on if pressed once. Turns the scanner off if held down for 3 seconds while the scanner is on. (You cannot turn the scanner off when the scanning software is running.)
	 Start	EPSON Scan starts.
 Copy		The Copy Utility starts.
 Scan to E-mail		EPSON Scan automatically scans, then the Send File Via E-mail window appears.
 Scan to PDF		The Scan to PDF window appears.

See [Using the Scanner Buttons](#).

[Top](#) 

Home > Placing Originals on the Scanner

Placing Documents or Photos

Placing Documents or Photos on the Document Table

Placing Large or Thick Documents

Before scanning a document, remember to respect the rights of copyright owners. Do not scan published text or images without first checking their copyright status.

Caution:

Do not place heavy objects on the document table glass and do not press the glass with too much force.

Note:

Most illustrations in this section show the EPSON Perfection V370 Photo, so they may differ slightly from the EPSON Perfection V37. The instructions are the same, except as noted.

Placing Documents or Photos on the Document Table

1 Open the scanner cover.

EPSON Perfection V370 Photo: Make sure the document mat is installed inside the cover. If it is not installed, see [Replacing the Document Mat](#) for details.

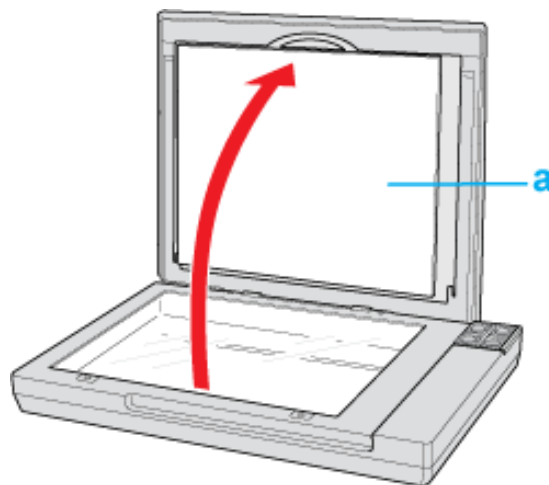

a. document mat

2 Place your document or photo face down on the document table. Make sure the upper left corner of the document or photo is against the corner of the scanner, next to the arrow mark.

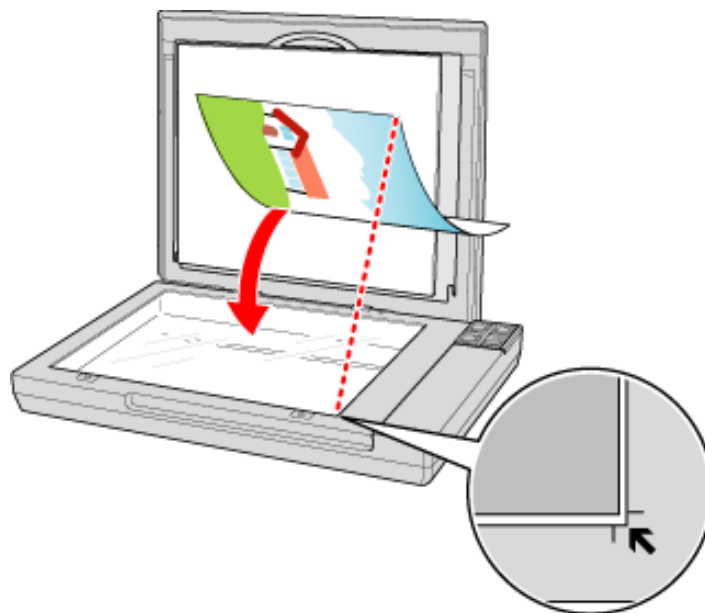

 **Note:**

If you are scanning multiple photos at once, position each photo at least 0.8 inch (20 mm) apart from the others.

- 3** Close the scanner cover gently so that your original does not move.

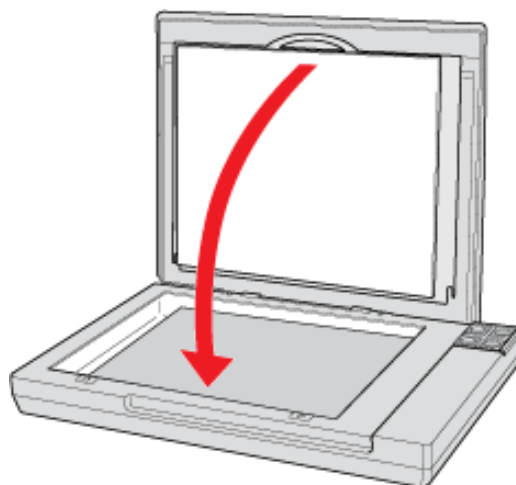

 **Note:**

- Always keep the document table clean.
- Do not leave photos on the document table for an extended period of time as they may stick to the glass.

Top 

Placing Large or Thick Documents

When you scan a large or thick document, you can open the scanner cover all the way, so that it lies flat next to the scanner.

- 1 Open the scanner cover.
- 2 Pull the scanner cover straight up.

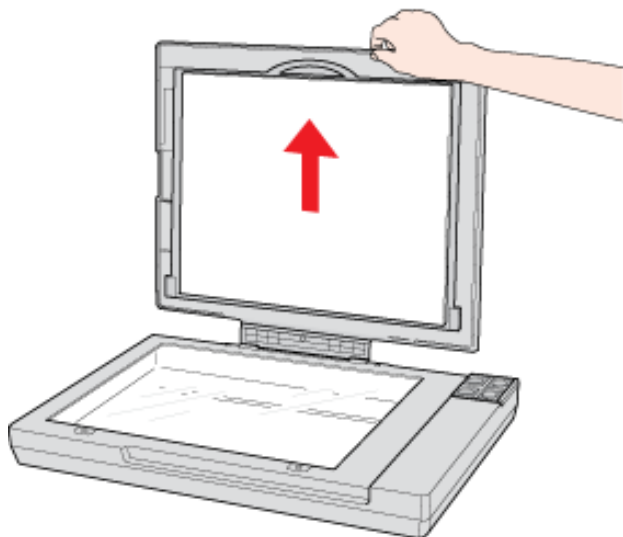

- 3 Lay the cover down flat next to the scanner.

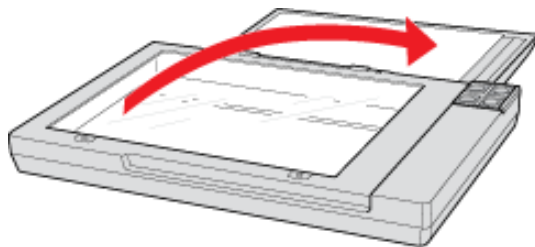

 **Note:**

When scanning without the scanner cover, gently press down on your document to flatten it.

When you are finished scanning, replace the scanner cover in the reverse order that you removed it.

Home > Placing Originals on the Scanner

■ Placing Film or Slides (EPSON Perfection V370 Photo Only)

- ▾ Removing the Document Mat
- ▾ Placing Film in the Holder
- ▾ Placing Slides in the Holder
- ▾ Storing the Film Holder
- ▾ Replacing the Document Mat

Removing the Document Mat

To scan film strips or slides, you need to remove the document mat from the scanner cover. This uncovers the transparency unit window so your scanner can use it to scan your film or slides.

- 1 Open the scanner cover and gently slide up the document mat to remove it.

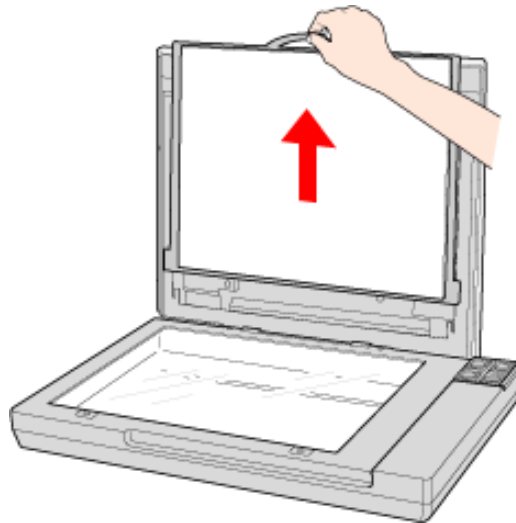

- 2 Use a soft cloth to wipe the transparency unit window and the document table before placing your film or slides.

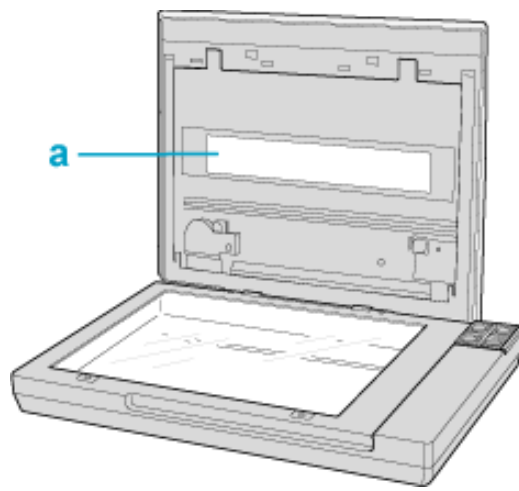

a. transparency unit window

To place film for scanning, see [Placing Film in the Holder](#).

To place slides for scanning, see [Placing Slides in the Holder](#).

To replace the document mat, see [Replacing the Document Mat](#).

[Top](#) 

Placing Film in the Holder

1 Open the cover of the 35 mm film strip holder.

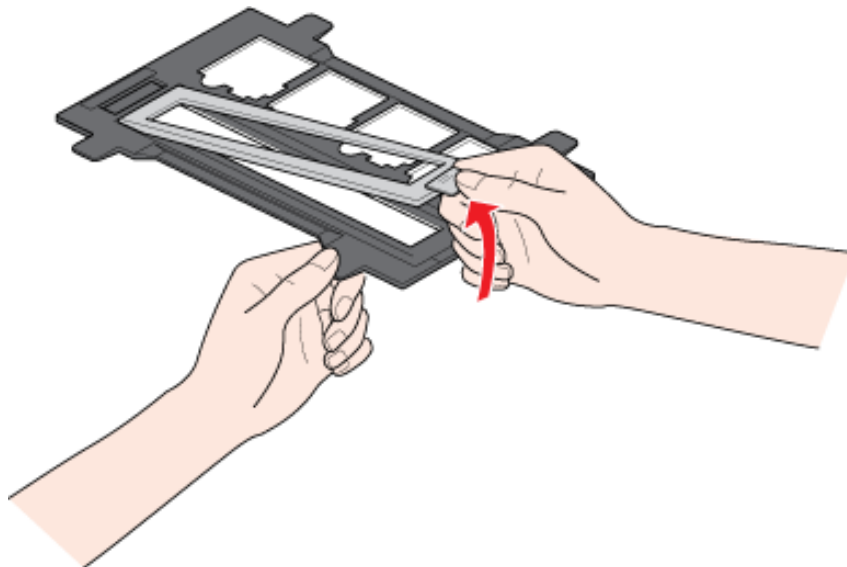

2 Slide your film strip all the way into the film holder with the shiny base side facing down. Your images and any wording on the film strip should appear backwards on the side that faces up.

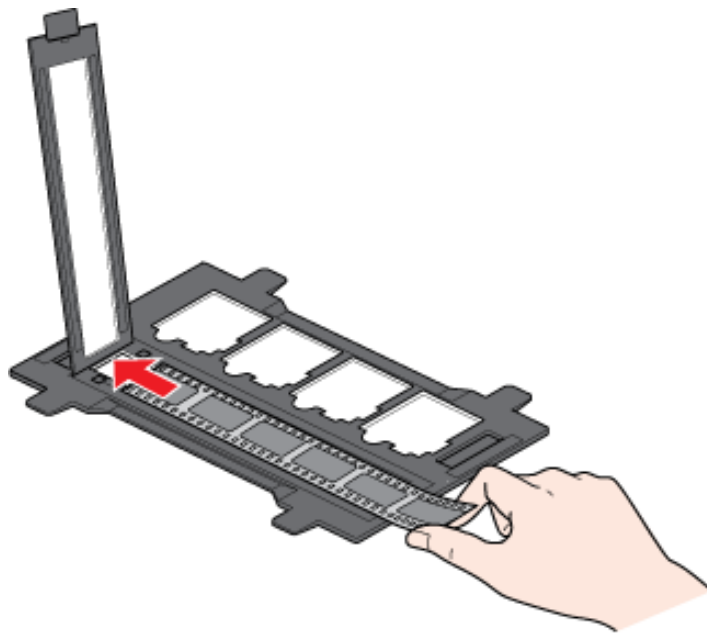

 **Note:**

- Hold the edge of the film gently or use gloves to touch the film; otherwise you may damage the film.
- Make sure the white stickers on the back of the film holder and the areas around them are not scratched, dusty, or covered in any way. If the areas are obscured, the scanner may have trouble recognizing your film in Full Auto Mode.
- Do not cover the small holes in the film holder.

3 Close the cover and press it down until you hear a click. Then press down on all the edges of the cover to secure it.

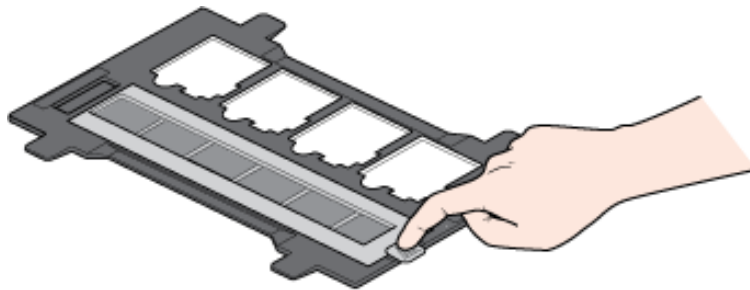

4 Make sure the film strip is placed as shown.

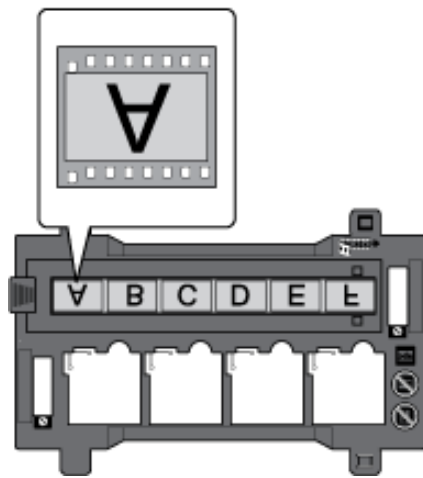

- 5 Place the film holder on the document table so that it is aligned as shown. Make sure the tab with the film icon on the film holder fits into the area with the same icon on the scanner.

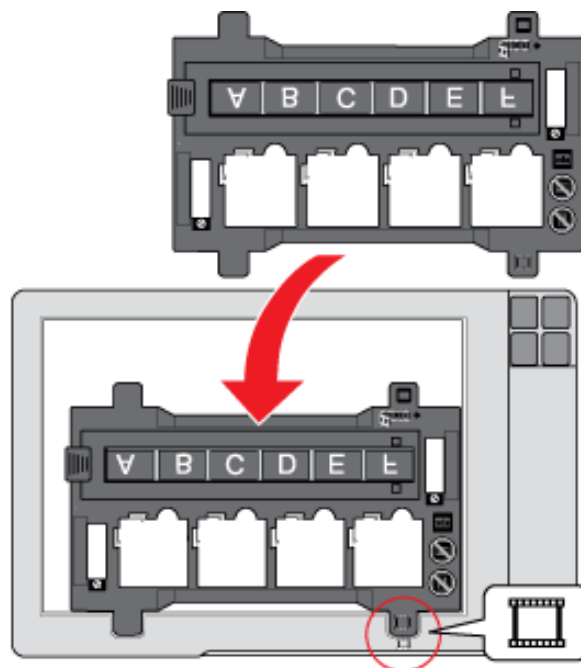

- 6 Make sure you removed the document mat. See [Removing the Document Mat](#).

- 7 Close the scanner cover.

To scan your film, see [Using the Scanner Buttons](#).

When you are finished scanning film, be sure to replace the document mat before scanning documents or photos. See [Replacing the Document Mat](#).

[Top](#)

Placing Slides in the Holder

You can scan up to four 35 mm slides at a time using the slide portion of the film holder.

 **Note:**

- You cannot scan negative slides with Full Auto Mode.
- Make sure the white stickers on the back of the film holder and the areas around them are not scratched, dusty, or covered in any way. If the areas are obscured, the scanner may have trouble recognizing your slides in Full Auto Mode.
- Do not cover the small holes on the film holder.

- 1** Place the film holder on the document table so that it is aligned as shown. Make sure the tab with the slide icon on the film holder fits into the area with the same icon on the scanner.

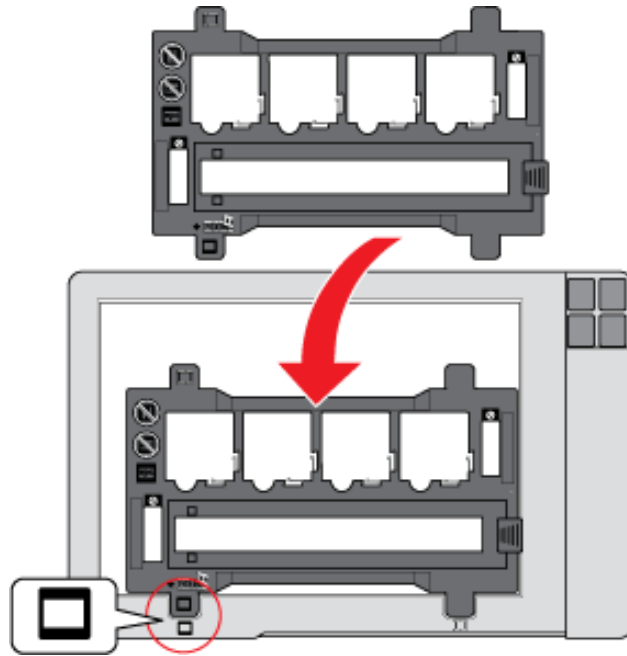

- 2** Place up to four slides in the film holder with the shiny base side facing down. Your images should appear backwards on the side that faces up. Your images should be oriented as shown.

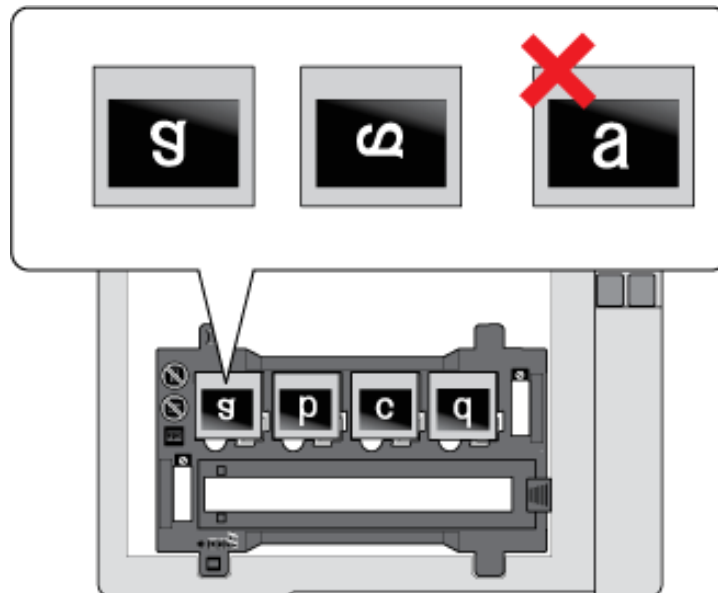

 **Note:**



Make sure you place the long edge of the slide in the film holder as shown above.

3 Make sure you removed the document mat. See [Removing the Document Mat](#).

4 Close the scanner cover.

To scan your film, see [Using the Scanner Buttons](#).

When you are finished scanning slides, be sure to replace the document mat before scanning documents or photos. See [Replacing the Document Mat](#).

[Top](#)

Storing the Film Holder

When you are not using the film holder, you can store it inside the scanner cover.

1 Open the scanner cover and remove the document mat. See [Removing the Document Mat](#) for details.

2 Slide the film holder into the scanner cover.

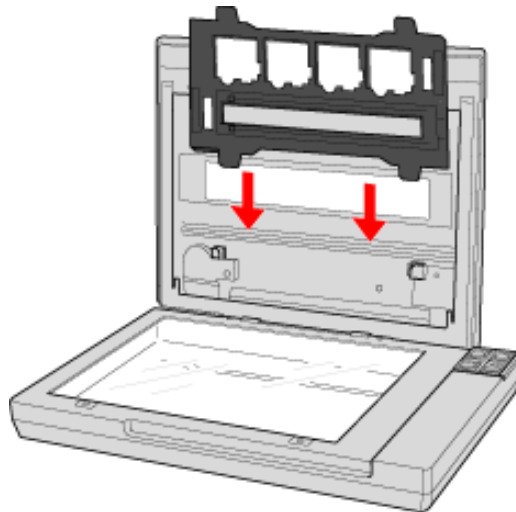

3 Replace the document mat. See [Replacing the Document Mat](#) for details.

[Top](#)



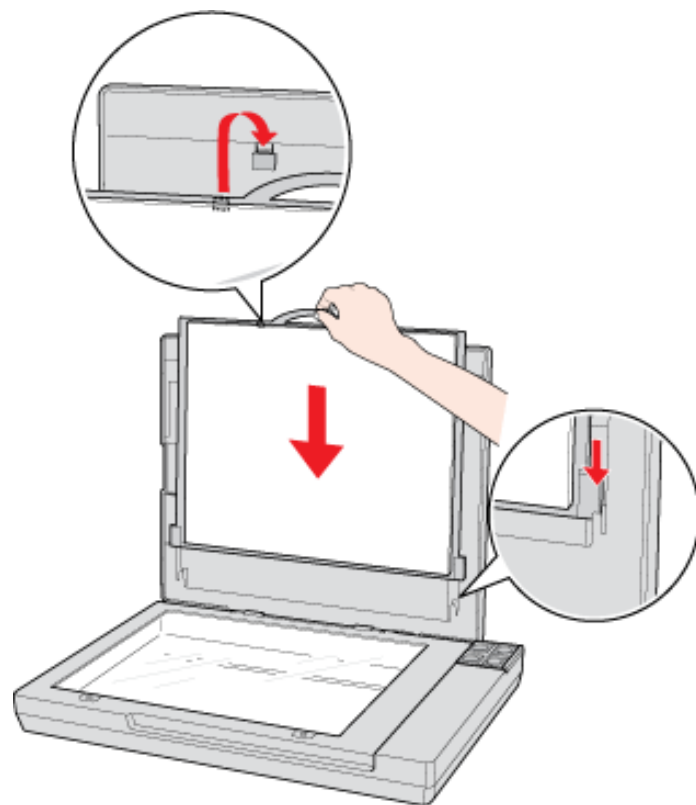

Replacing the Document Mat

Replace the document mat by sliding it into the notches in the scanner cover. Make sure the white surface faces outwards.

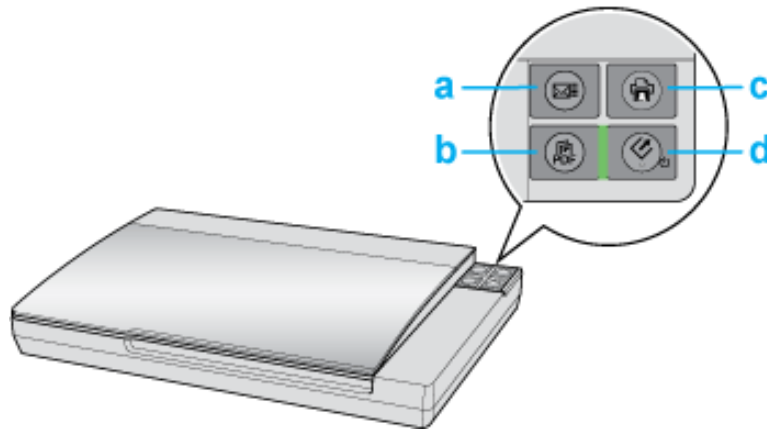





Using the Scanner Buttons



- a.  E-mail button
- b.  PDF button
- c.  Copy button
- d.  Power/ Start button

You can start scanning by pressing the following buttons on the scanner.

-  Start button lets you start EPSON Scan. See [EPSON Scan Mode](#) for details.
-  PDF button lets you scan multiple originals and save them as one PDF file on your computer. See [Scanning to a PDF File](#) for details.
-  E-mail button lets you scan and attach the image file to an e-mail message. See [Scanning Directly to an E-mail](#) for details.
-  Copy button lets you use your scanner along with a printer connected to your computer just like you would use a copy machine. See [Using the Scanner as a Copier](#) for details.

Home > Scanning Your Originals

■ Using Document Capture Pro (for Windows)/Document Capture (for Mac OS X)

 **Note:**

For details about the software, see Document Capture Pro/Document Capture help.

- 1 For Windows, select the start button icon or **Start > All Programs** or **Programs > EPSON Software > Document Capture Pro**.

For Mac OS X, select **Applications > Epson Software**, and then double-click **Document Capture**.

- 2 For Windows, click **Scan** on the main window.

For Mac OS X, click **Scan** icon on the main window.

- 3 Make necessary settings, click **Scan**.

- 4 Check the scanned images, and then perform the image editing as needed.

- 5 For Windows, when you have finished checking, click **Destination** or **Save As**.

For Mac OS X, when you have finished checking, click **Destination** icon.

- 6 Make necessary settings, and then click **OK**.

[Home](#) > [Scanning Your Originals](#)

Using Another Scanning Program

You can use any TWAIN-compliant scanning program, such as Adobe Photoshop Elements, to scan with your scanner. You open the program, select **EPSON Scan**, and **Scan**. When you are finished scanning, the scanned image opens in your scanning program so you can modify, print, and save it.

- 1 Start a TWAIN-compliant scanning program. Double-click the program icon on the desktop, if it is available, or do one of the following.

Windows:

Select the start button or **Start** > **All Programs** or **Programs** > program folder > program icon.

Mac OS X:

Open the **Applications** in your hard drive, select the program folder, and double-click the program icon.

- 2 Do one of the following.

Adobe Photoshop Elements:

Windows:

Click **Edit and Enhance Photos**, open the **File** menu, select **Import**, and select your scanner.

Mac OS X:

Click **Close** in the Welcome window if it appears, open the **File** menu, select **Import**, and select your scanner.

ArcSoft MediaImpression:

Click **Pictures**, click **Acquire**, and select your scanner.

ArcSoft PhotoImpression:

Windows:

Click **Get Photos**, click **Acquire from Scanner**, and select your scanner.

Mac OS X:

Open the **File** menu, select **Get Photo**, select **Camera/Scanner**, and select your scanner.

ArcSoft Scan-n-Stitch Deluxe (Windows only):

Select your scanner from **Selected Scanner**, and then click **Scan Page**.

Presto! PageManager:

Open the **File** menu, select **Select Source**, and select your scanner.

In some programs, you must select the scanner as the "source" first. If you see a Select Source option, select it and select your scanner there first.

 **Note for Windows 7, Vista, and XP users:**

Do not select a WIA option for your scanner from the Import or Acquire list; you will not be able to use all the features of your scanner.

The EPSON Scan window automatically opens. See [EPSON Scan Mode](#) for details.

After scanning, your scanned image is displayed in the program window. If EPSON Scan does not automatically close after scanning, click **Close** to exit the EPSON Scan window and view your image in the program window.

EPSON Scan Mode

EPSON Scan offers several scanning modes to choose from.

- **Full Auto Mode** lets you scan quickly and easily, without selecting any settings or previewing your image. Full Auto Mode is best when you need to scan your originals at 100% size and you do not need to preview the images before scanning. You can restore faded colors or remove dust marks in Full Auto Mode. This is the default mode in EPSON Scan.
 - See the EPSON Scan help for details.
- **Home Mode** lets you customize some scanning settings and check their effects with a preview image. Home Mode is best when you want to preview images of your originals before scanning them. You can size the image as you scan, adjust the scan area, and adjust many image settings, including color restoration, dust removal, and backlight correction.
 - See the EPSON Scan help for details.
- **Office Mode** lets you quickly select settings for scanning text documents and check their effects with a preview image.
 - See the EPSON Scan help for details.
- **Professional Mode** gives you total control of your scanning settings and lets you check their effects with a preview image. Professional Mode is best when you want to preview your image and make extensive, detailed corrections to it before scanning. You can sharpen, color correct, and enhance your image with a full array of tools, including color restoration, dust removal, and backlight correction.
 - See the EPSON Scan help for details.

To change the scan mode, click the arrow in the Mode box in the upper right corner of the EPSON Scan window. Then, select the mode you want to use from the list that appears.

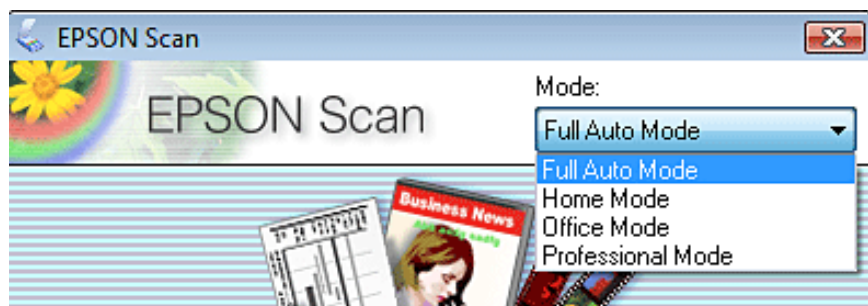

 **Note:**

The mode you select remains in effect when you start EPSON Scan next time.

[Home](#) > [Scanning Special Projects](#)

■ Scanning to SharePoint or Cloud Service

You can upload images to cloud services such as Google Docs/Evernote.

For Windows:

1 Start Document Capture Pro and scan your document.

 [Using Document Capture Pro \(for Windows\)/Document Capture \(for Mac OS X\) steps 1 to 4](#)

2 On the main window, click the destination icon, and make settings on the Transfer Settings window.

 See help for more details on Document Capture Pro.

3 Click **Destination Settings**.

4 On the settings window, click **Add** and make destination settings, and then click **OK**.

5 Click **OK** to return to the Transfer Settings window.

6 Check the Destination Name, and then click **OK**.

The image is uploaded.

For Mac OS X:

1 Start Document Capture and scan your document.

 [Using Document Capture Pro \(for Windows\)/Document Capture \(for Mac OS X\) steps 1 to 4](#)

2 On the main window, click the destination icon, and then make settings.

 See help for more details on Document Capture.

3 Click **Send**.

The image is uploaded.

Home > Scanning Special Projects

■ Scanning to a PDF File

 [Scanning to a PDF File Using the PDF Button](#)

 [Scanning to a PDF File Using EPSON Scan](#)

Using EPSON Scan, you can create a PDF file with the following features:

Scanning multiple document pages into a single PDF file: You can scan multiple document pages and save them in a single PDF file.

Creating a searchable PDF file (Windows only): You can create a PDF file with search functionality, so that you can look for words in the file. (This feature may not be available in some countries.)

Specifying the number of pages in a single PDF file: You can specify the maximum number of pages that can be included in one PDF file. For example, if you are scanning a 20-page document, and specify the page number to be included in one PDF as 4, 5 PDF files are automatically created.

 **Note:**

You need ABBYY FineReader that came with your scanner to use some of these features. If you have installed your scanning software as described in the Start Here sheet, it has already been installed.

Scanning to a PDF File Using the PDF Button

- 1** Place your document on the document table. See [Placing Documents or Photos](#) for details.
- 2** Press the  scan to PDF button on the scanner. You see the Scan to PDF window.

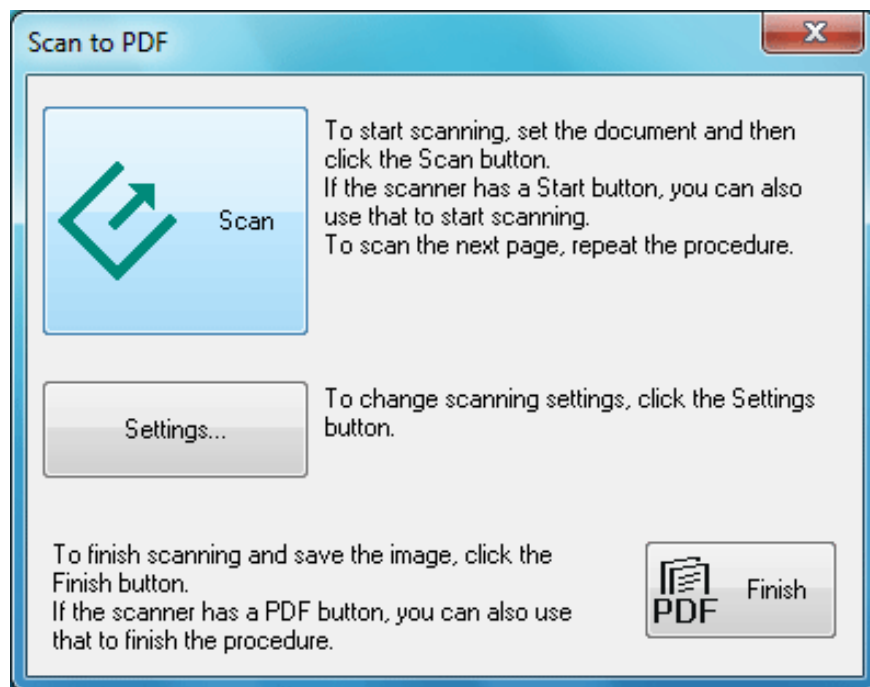

- 3 Click **Settings**. You see the Scan to PDF Settings window.

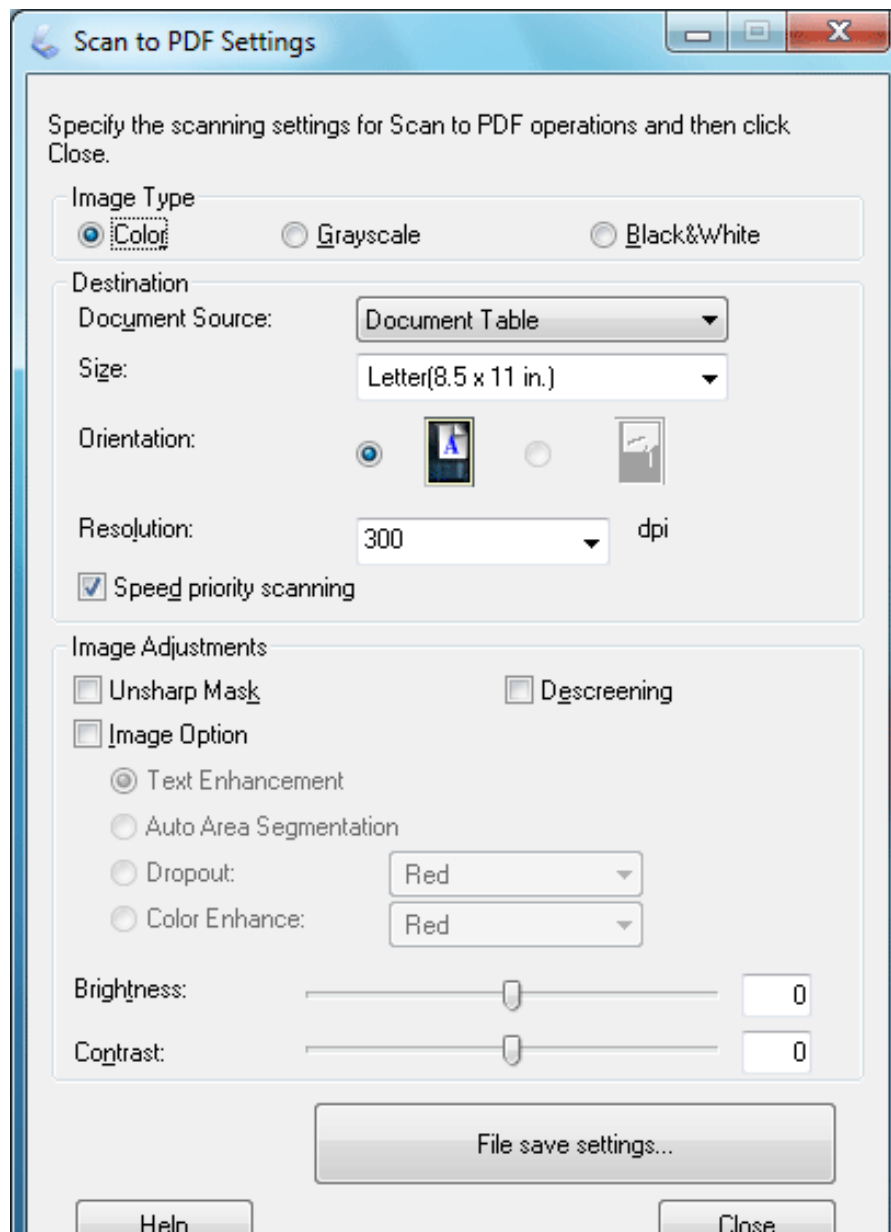

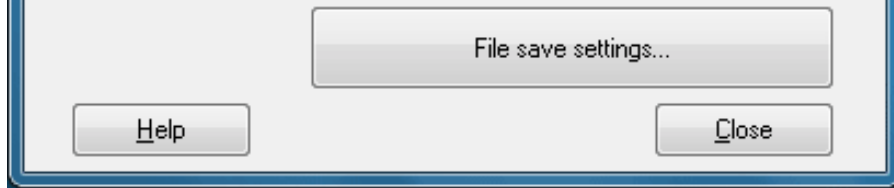

- 4 Select **Color**, **Grayscale**, or **Black&White** as the Image Type setting to select the colors in the original.
- 5 Select **Document Table** as the Document Source setting.
- 6 Click the arrow to open the **Size** list and select the size of your original(s).
- 7 If you need to select a size that is not in the Size list, you can create a custom size. Click the arrow in the Size list and select **Customize**. You see the Source Size window.

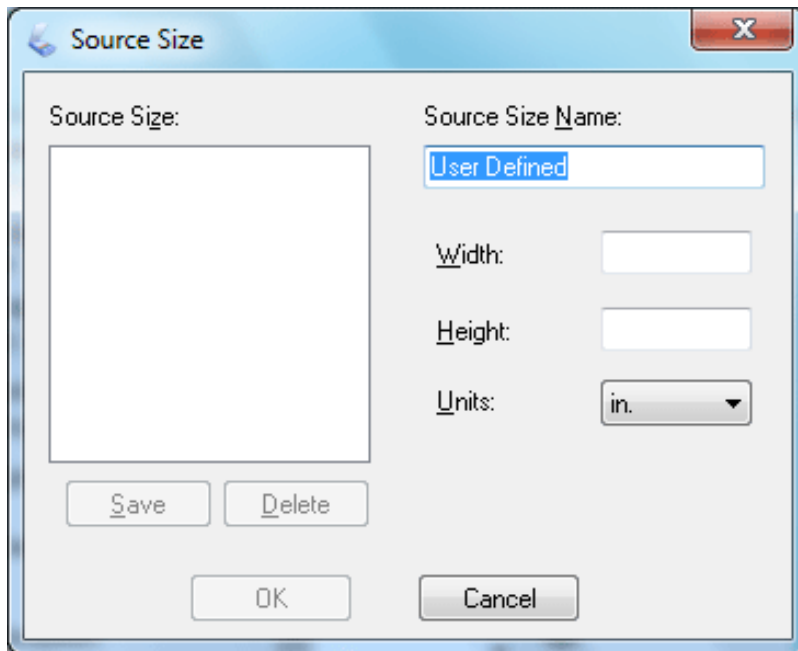

Type a name for your custom size, enter the size, click **Save**, then click **OK**. Your new size appears in the Size list.

- 8 Click the arrow next to the **Resolution** list and select the number of dots per inch at which you want to scan. See the table below for guidelines.

What you will do with the scanned image	Suggested scan resolution
Send via e-mail, upload to web, view only on the screen	96 to 150 dpi
Fax	200 dpi
Print	300 dpi

- 9 Use the settings in the Image Adjustments area of the window to modify the image quality if necessary. See the table below for guidelines.

Setting	Description
Brightness	Adjusts the overall image lightness and darkness. This setting is available only when the Image Type is set to Color or Grayscale.

Contrast		Adjusts the difference between the light and dark areas of the overall image. This setting is available only when the Image Type is set to Color or Grayscale.
Unsharp Mask		Turn on to make the edges of image areas clearer for an overall sharper image. Turn off to leave softer edges. This setting is available only when the Image Type is set to Color or Grayscale.
Descreening		Removes the rippled pattern that can appear in subtly shaded image areas, such as skin tones. Also improves results when scanning magazine or newspaper images that include screening in their original print process. This setting is available only when the Image Type is set to Color or Grayscale.
Image Option	Text Enhancement	Enhances text recognition when scanning text documents. This setting is available in the following conditions: <ul style="list-style-type: none"> - when the Image Type is set to Color and Image Option is selected - when the Image Type is set to Grayscale and Image Option is selected - when the Image Type is set to Black&White and Image Option is selected When the Image Type is set to Black&White, the results of Text Enhancement do not appear in the preview, only in your scanned image.
	Auto Area Segmentation	Makes Black&White images clearer and text recognition more accurate by separating the text from the graphics. This setting is available only when the Image Type is set to Black&White and Image Option is selected.
	Dropout	Drops out red, green, or blue in the scan. This setting is available in the following conditions: <ul style="list-style-type: none"> - when the Image Type is set to Grayscale and Image Option is selected - when the Image Type is set to Black&White and Image Option is selected
	Color Enhance	Enhances red, green, or blue in the scan. This setting is available in the following conditions: <ul style="list-style-type: none"> - when the Image Type is set to Grayscale and Image Option is selected - when the Image Type is set to Black&White and Image Option is selected
Threshold		Adjusts the level at which the black areas in text and line art are delineated, improving text recognition in OCR programs. This setting is available only when the Image Type is set to Black&White.

10 Click **File Save Settings**. The current Paper Size, Orientation, Margin, and other settings are displayed under Details.

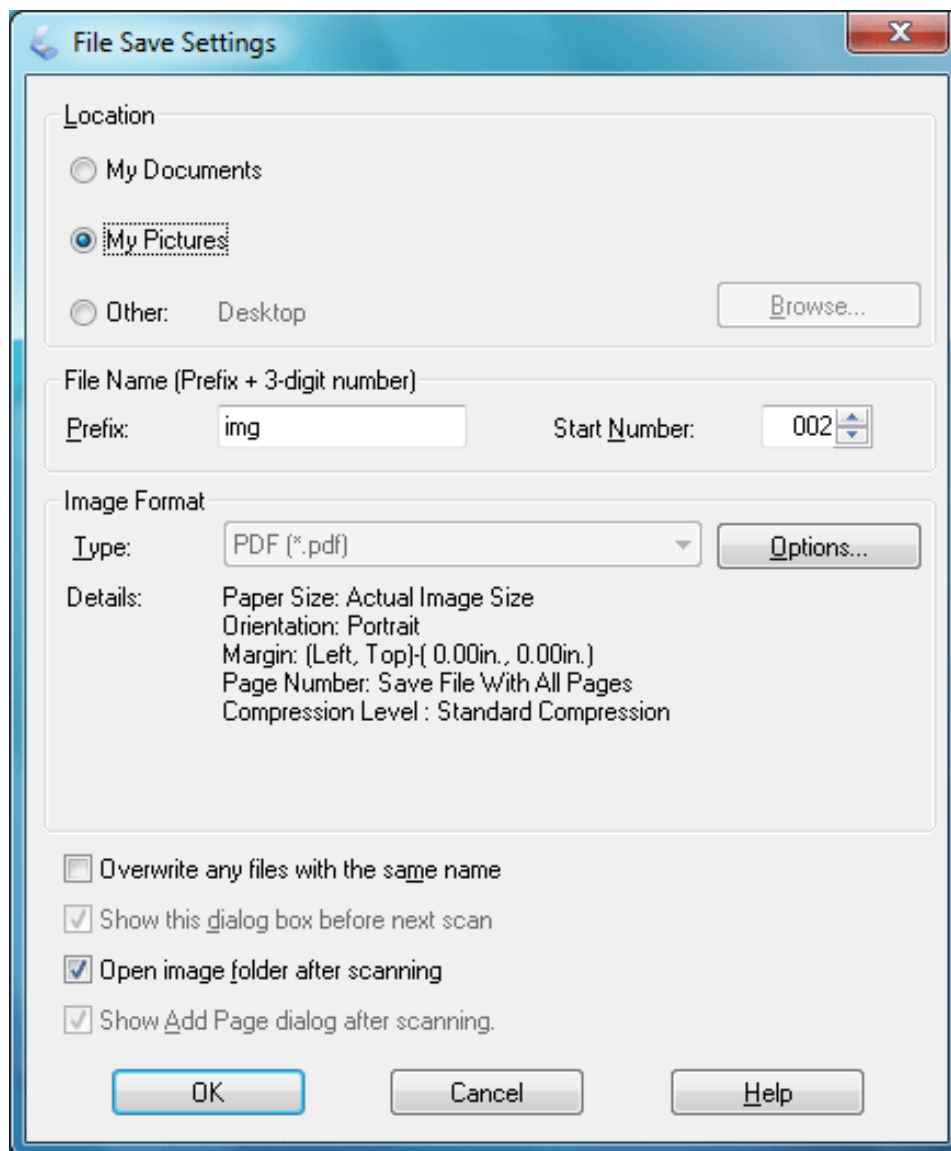

 **Note:**

If you deselect the **Show Add Page dialog after scanning** checkbox in the File Save Settings window, the Add Page Confirmation window does not appear and EPSON Scan automatically saves your document.

11 If you need to change any of the current PDF settings, click **Options**.

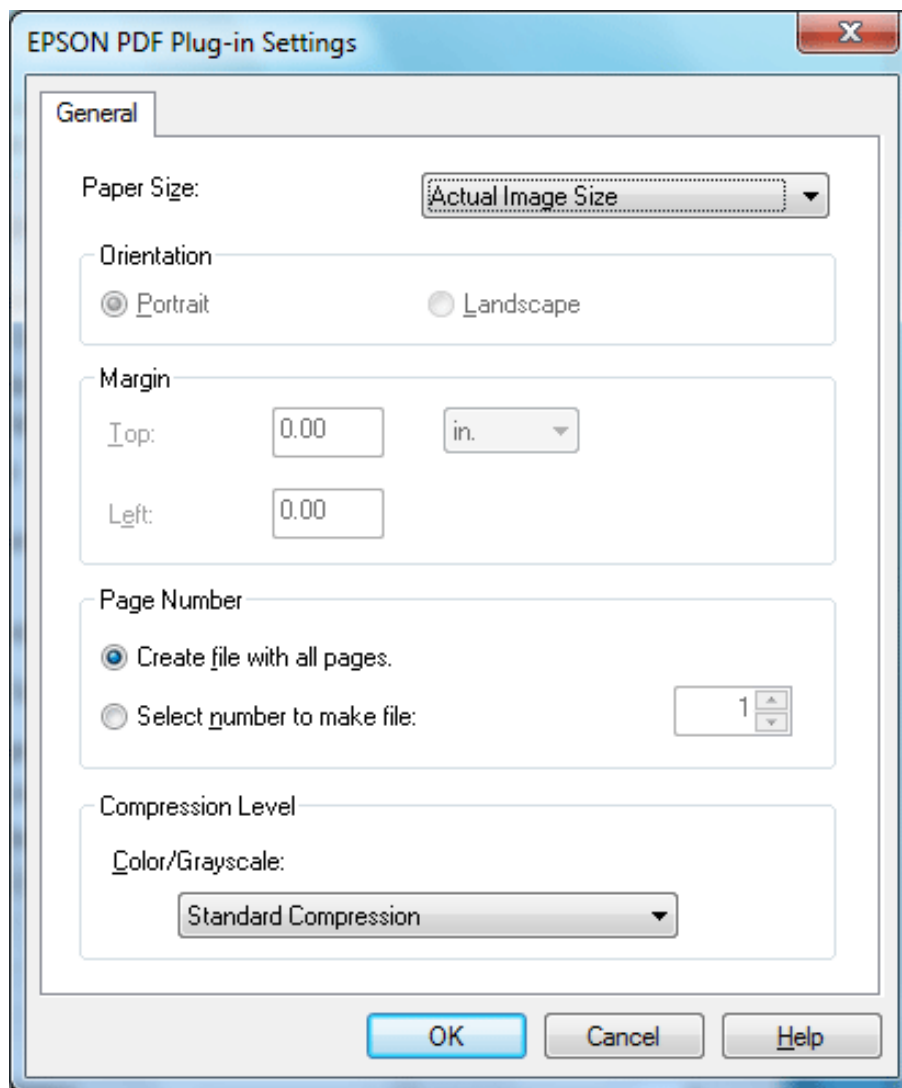



 **Note:**

The Text tab is available only when ABBYY FineReader that came with your scanner is installed.

Select the settings that match your document and click **OK**. You return to the File Save Settings window.

For other settings in the EPSON PDF Plug-in Settings window, see EPSON Scan Help.

- 12 Make any other file save settings and click **OK**.
- 13 Click **Close** to close the Scan to PDF Settings window, then click **Scan** or press the  Start button on the scanner. EPSON Scan scans your page.

If you are scanning single page, go to step 15.
- 14 If you are scanning multiple pages, replace the first page on the document table with the second page and click **Scan** or press the  Start button again. Repeat this step for each page in your document.
- 15 Click **Finish** or press the  scan to PDF button on the scanner. Your document is saved as a PDF file in the Pictures or My Pictures folder, or in the location you selected in the File Save Settings window.

Scanning to a PDF File Using the EPSON Scan

- 1 Place your document on the document table. See [Placing Documents or Photos](#) for details.
- 2 Start EPSON Scan.
- 3 Make necessary settings.
Full Auto Mode: Click **Customize** and **File Save Settings**. Go to step 5.
- 4 Click **Scan**.
- 5 Select **PDF** as the Type setting. The current Paper Size, Orientation, Margin, and other settings are displayed under Details.

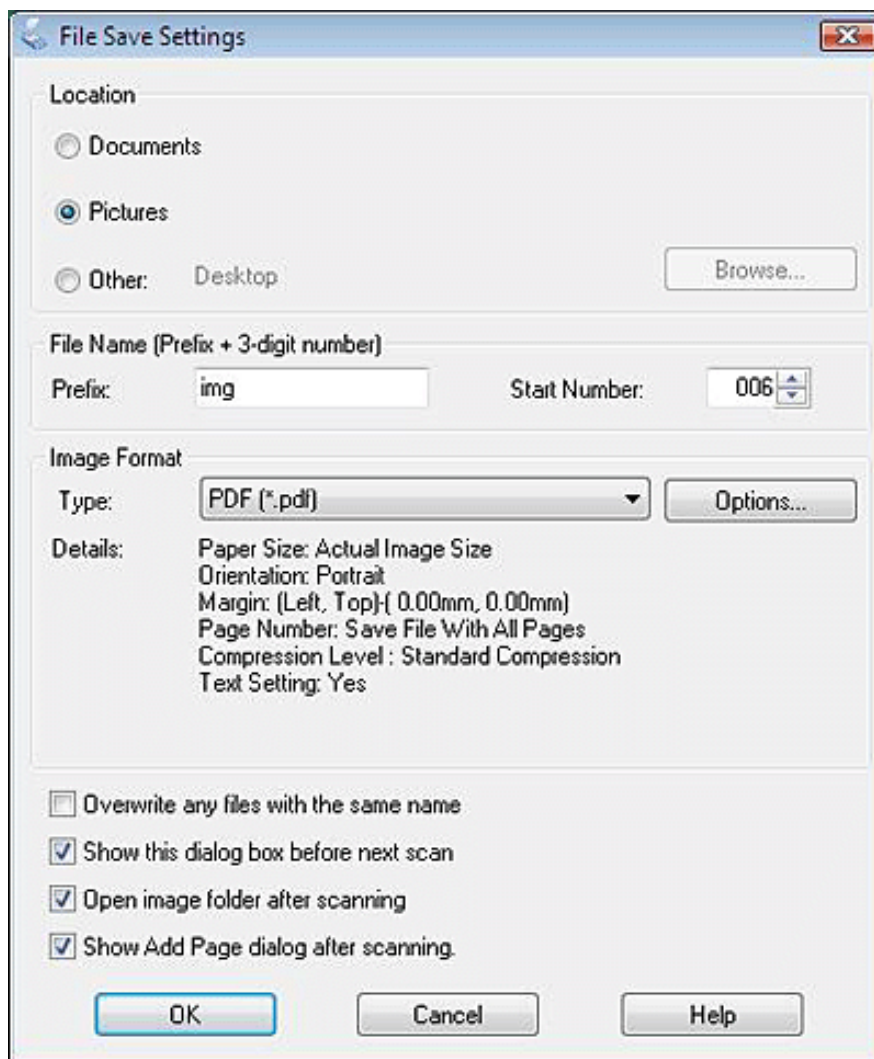

Note:

If you deselect the **Show Add Page dialog after scanning** checkbox in the File Save Settings window, this window does not appear and EPSON Scan automatically saves your document.

6 Click **Options** for detailed settings.

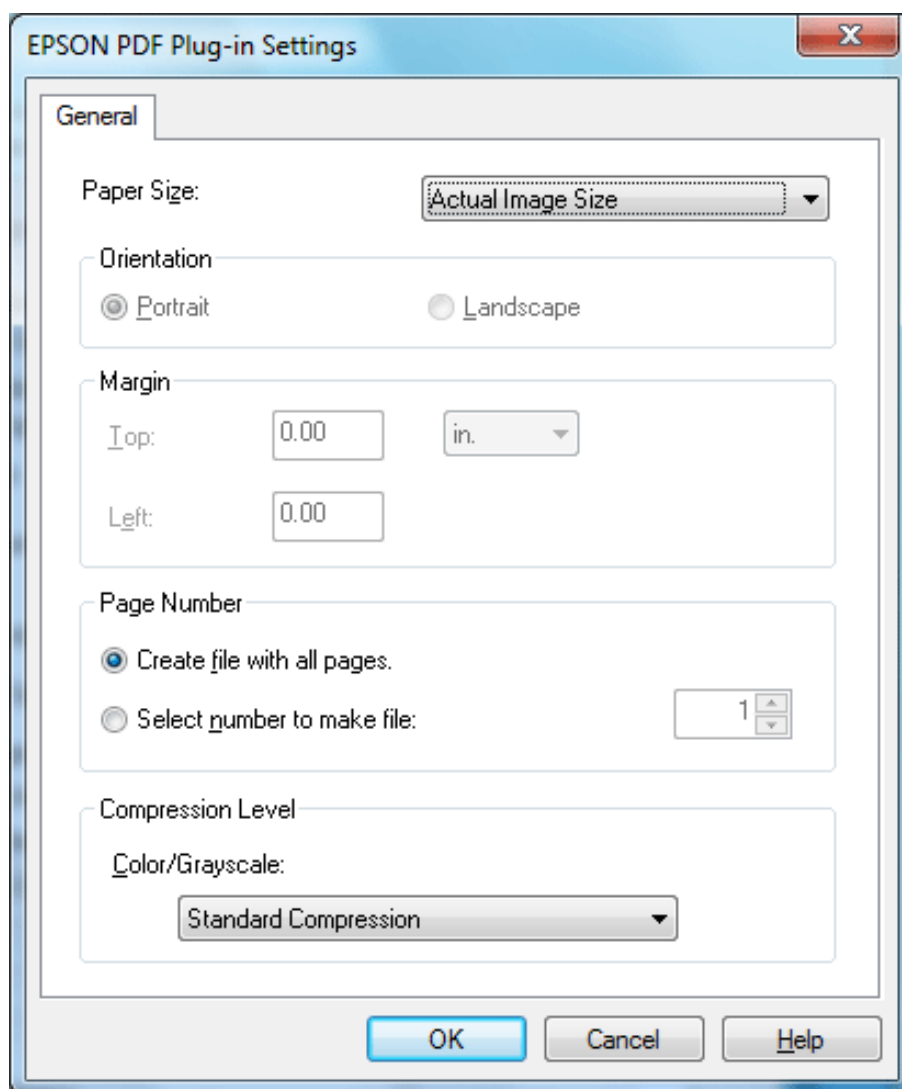

 **Note:**

The Text tab is available only when ABBYY FineReader that came with your scanner is installed.

Select the settings that match your document and then click **OK**. You return to the File Save Settings window. For other settings in the EPSON PDF Plug-in Settings window, see EPSON Scan Help for details.

7 Make any other file save settings, and then click **OK**.

Full Auto Mode: Click **OK** in the Customize window, and then click **Scan**.

EPSON Scan starts scanning your document and displays the following window.

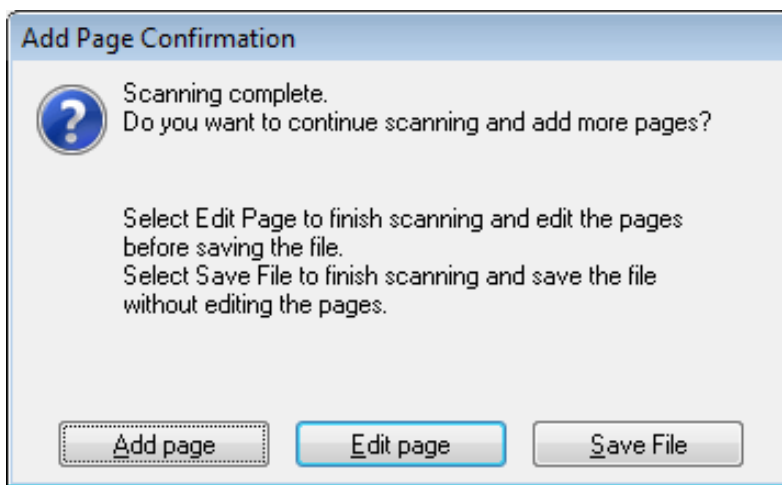

8 Select one of the following options:



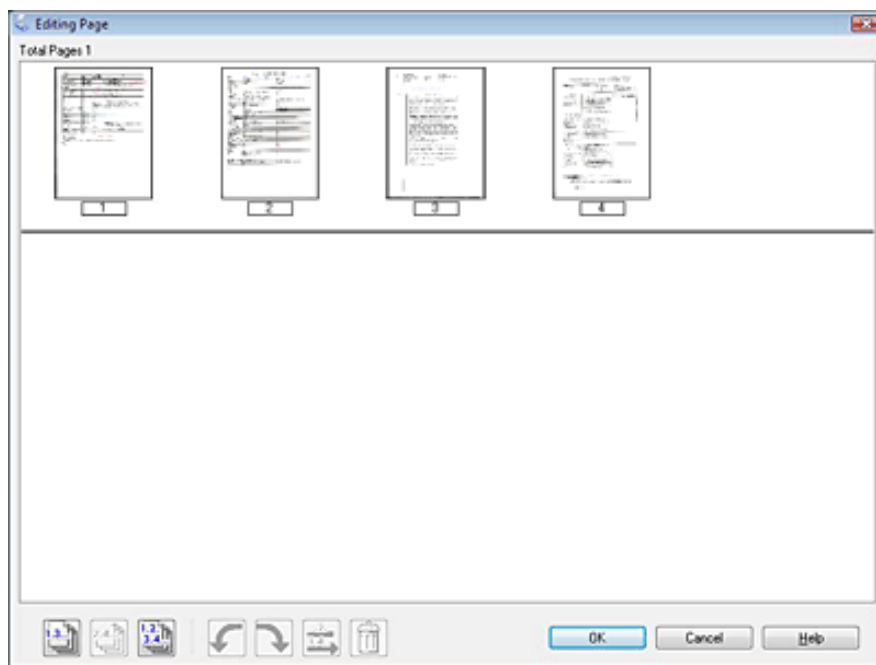

- **Add page:** Click this button to scan the next page of your document. Replace the first page on the document table with the next page, and click **Scan**. Repeat this step for each page in your document. When you are finished, click **Edit page** and go to step 9.
- **Edit page:** Click this button if you have scanned all the necessary pages so you can edit the scanned pages before saving them in one PDF file. Then go to step 9.
- **Save File:** Click this button when you are ready to finish scanning and save the scanned pages into one PDF without editing them. Then go to step 11.

9 You see the Editing Page window displaying thumbnail images of each scanned page.



Use the tools below the Editing Page window to select, rotate, reorder, and delete pages.

If you want to include all the document pages in your PDF files as they currently look, go to step 13.

If you want to rotate pages, click the pages, or use the  odd pages,  even pages, or  all pages icon to select the pages, then click the  left or  right rotate icon to rotate them.

If you want to delete pages, click the pages, or use the  odd pages, or  even pages icon to select the

pages, then click the  delete icon to delete them.

 **Note:**

The  delete icon is not available when all pages are selected.

For further details on the tools in the Editing Page window, see EPSON Scan Help.

10 When you have finished editing your pages, click **OK**. The pages are saved in one PDF file in Pictures, My Pictures, or the location you selected in the File Save Settings window, and you return to the Office Mode window.

11 Click **Close** to exit EPSON Scan.

[Top](#) 

Using the Scanner as a Copier

You can use your scanner along with a printer connected to your computer just like you would use a copy machine. You can even enlarge and reduce, restore faded colors, remove dust, enhance text, and adjust image brightness and contrast as you copy.

- 1 Place your original(s) on the document table. See one of these sections for details:

Documents or photos: [Placing Documents or Photos](#)

Film or slides: [Placing Film or Slides \(EPSON Perfection V370 Photo Only\)](#)

- 2 Start the Copy Utility in one of these ways:

▣ Press the  Copy button on the scanner.

▣ **Windows:** Click the  Start button icon or **Start > Programs** or **All Programs > EPSON Software > Copy Utility**.

▣ **Mac OS X:** Select **Applications > EPSON Software > Copy Utility**, and double-click the **Copy Utility** icon.

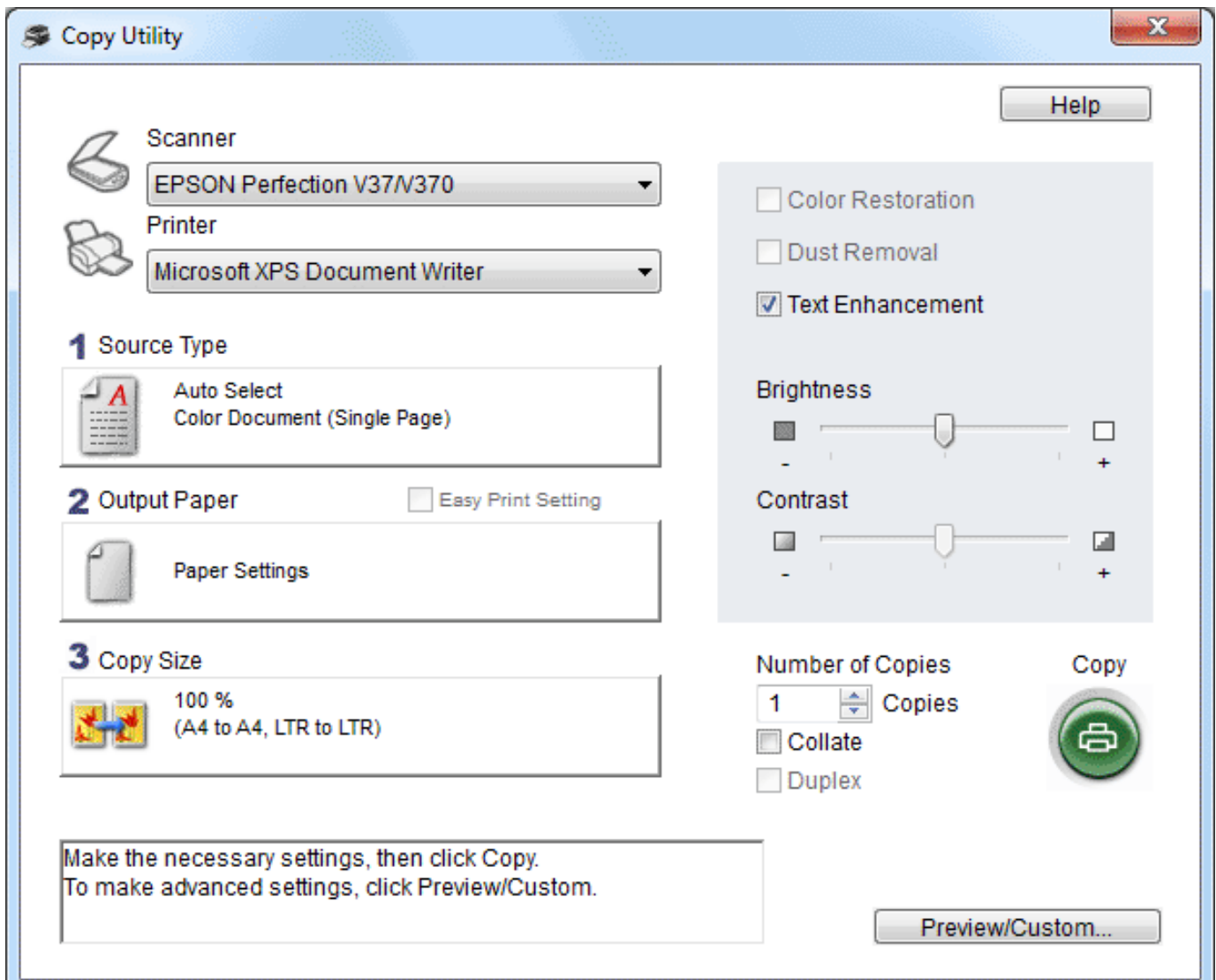

make the necessary settings, then click Copy.
To make advanced settings, click Preview/Custom.

Preview/Custom...

- 3 Select your scanner from the **Scanner** list.
- 4 Select your printer from the **Printer** list.
- 5 Click the **Source Type** box, select the type of original(s) you are copying, and click **OK**. See the table below for guidance.

Source Type setting	Type of document
Color Document (Single Page)	One-page color documents containing text or text and graphics, such as a flyer.
Black & White Document (Single Page)	One-page black and white documents containing text or text and graphics, such as a letter.
Color Document (Multiple Pages)	Multiple page color documents containing text or text and graphics, such as a brochure.
Black & White Document (Multiple Pages)	Multiple page black and white documents containing text or text and graphics, such as a manual.
Photo	Color or black-and-white photographs.
Negative Film	Color negative film strips.
Positive Film	Color positive slides or positive film strips.

- 6 Click the **Output Paper** box, select the type and size of paper you loaded in your printer, and click **OK**.

 **Note:**

If you are printing on certain EPSON printers, you see the printer settings window. See your printer documentation for instructions on selecting settings.

- 7 If you want to enlarge or reduce your image(s) as you copy it, click the **Copy Size** box, select the enlargement/reduction, and click **OK**.

 **Note:**

If you are printing on an EPSON printer that supports borderless printing, you can select options for **Margins** (borders) or **No Margins** (borderless).

- 8 If you are copying a faded photo and want to restore the colors, click the **Color Restoration** check box. It is available only when the Source Type is **Photo**, **Negative Film**, or **Positive Film**.
- 9 If you need to remove dust marks as you copy, click the **Dust Removal** check box. It is available only when the Source Type is **Negative Film** or **Positive Film**.

- 10 If you are copying a color or black-and-white document, you can improve the definition of text and line art by leaving the **Text Enhancement** check box checked. It is available only when the Source Type is **Color Document (Single Page)**, **Black & White Document (Single Page)**, **Color Document (Multiple Pages)**, or **Black & White Document (Multiple Pages)**.
- 11 If you need to adjust the lightness or darkness of your original(s) or adjust the contrast between them as you copy, click the slider beneath the **Brightness** and/or **Contrast** settings. Contrast is only adjustable when the Source Type is **Photo**, **Negative Film**, or **Positive Film**.
- 12 Click the arrow in the **Number of Copies** box to select the number of copies you want, if necessary.
- 13 When you are ready to scan and print, click **Copy**.

 **Note:**

If you want to preview your scan before printing it or select additional copy settings, click **Custom Copy** at the bottom of the window. Click **Help** in the Copy Utility for instructions on using the Custom Copy features.

[Home](#) > [Scanning Special Projects](#)

■ Scanning Directly to an E-mail

You can scan and automatically attach scanned image file(s) to an e-mail message with the  scan to E-mail button on the scanner.

 **Note:**

Not supported on Windows 7. See the readme file for currently supported E-mail applications.

1 Place your original(s) on the document table. See one of these sections for details:

Documents or photos: [Placing Documents or Photos](#)

Film or slides: [Placing Film or Slides \(Perfection V730 Photo Only\)](#)

2 Press the  scan to E-mail button on the scanner. EPSON Scan starts in Full Auto Mode and automatically scans your image as a JPEG file.

 **Note:**

- If you want to restore color in or remove dust from your images before scanning, click the **Pause** button to return to the Full Auto Mode window. Then click **Customize**, select your options, click **OK**, and click **Scan** to continue.
- If you want to scan in Office Mode, Home Mode or Professional Mode, click **Pause** to return to the Full Auto Mode window, then change the scan mode. See [Selecting an EPSON Scan Mode](#) for details.

After scanning is finished, you see the Send File Via E-mail window.

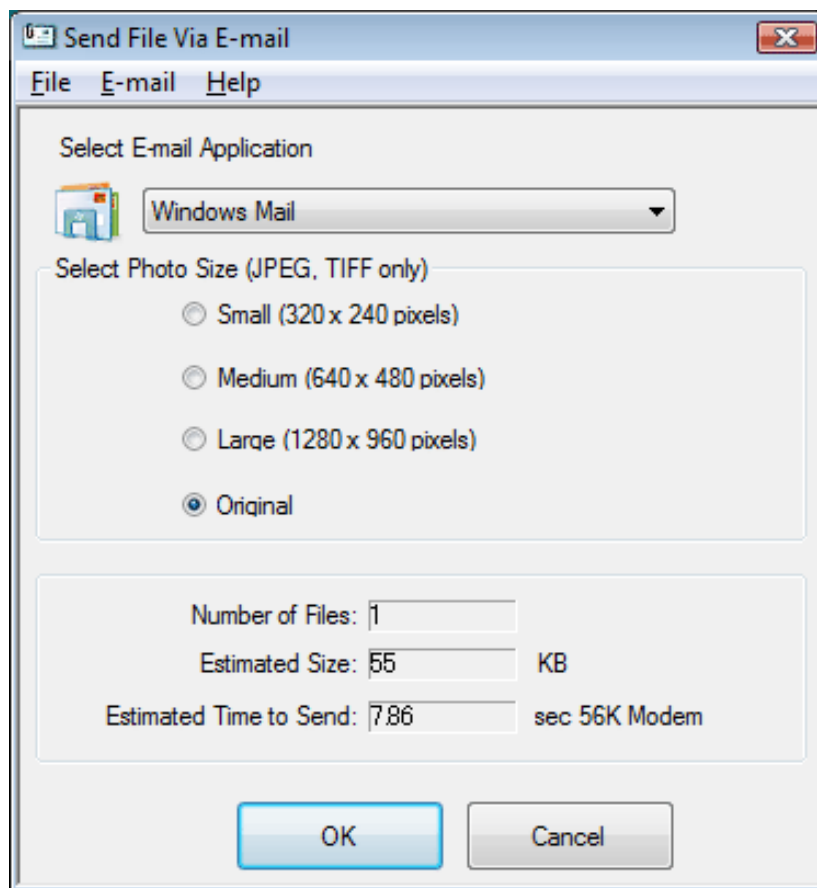

3 Select the e-mail program you use in the Select E-mail Application list.

4 If you want to resize your image(s), choose an option under Select Photo Size.

 **Note:**

The box at the bottom of the window displays information about the image file(s) you are attaching to the e-mail message.





5 Click **OK**. Your e-mail program is opened and any scanned images you selected are attached to a new e-mail message. See your e-mail program Help if you need instructions on sending your e-mail message.

Home > Scanning Special Projects

Assigning a Program to a Scanner Button

- ▾ [Assigning a Project Program in EPSON Event Manager to a Scanner Button](#)
- ▾ [Assigning a Program With Windows 7 and Vista](#)
- ▾ [Assigning a Program With Windows XP](#)

Each scanner button opens a pre-selected program when you press it. The default programs they open and the default actions they perform are described in the table below.

Button	Default action
 Start	EPSON Scan starts.
 Copy	EPSON Copy Utility starts.
 Scan to E-mail	EPSON Scan automatically scans, then the Send File Via E-mail window appears.
 Scan to PDF	The Scan to PDF window appears.

Assigning a Project Program in EPSON Event Manager to a Scanner Button

You can assign any of the scanner buttons to open a program in the EPSON Event Manager to make scanning your projects even quicker.

Each scanner button opens a pre-selected program when you press it. See [Using the Scanner Buttons](#) for the default settings.

- 1 Do one of the following to start EPSON Event Manager:

Windows: Click the  Start button icon or **Start > Programs** or **All Programs > EPSON Software > Event Manager**.

Mac OS X: Select **Applications > Epson Software**, and double-click the **Launch Event Manager** icon.

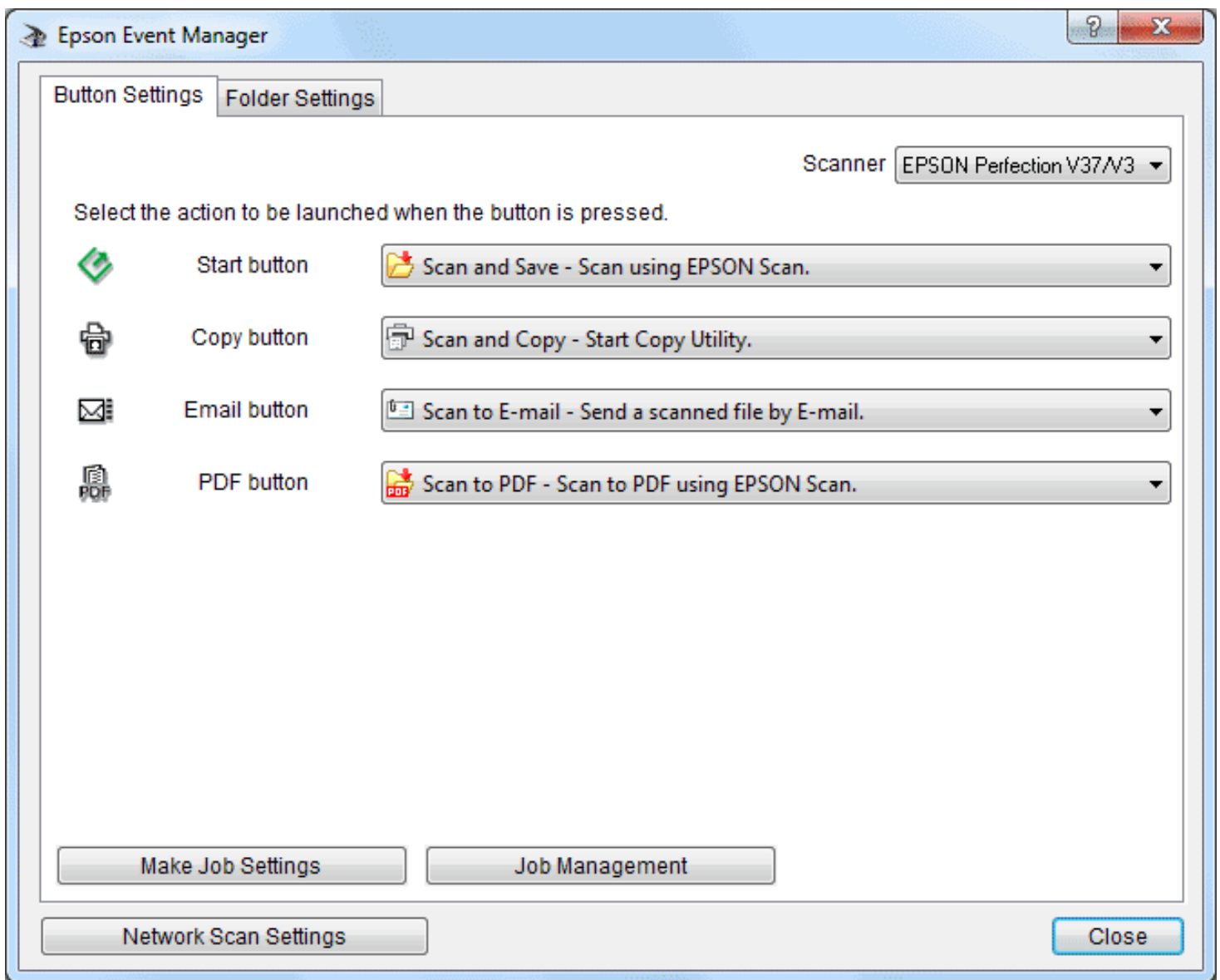

- 2 Select your scanner from **Scanner**.
- 3 Click the arrow in the list next to the button name, then select the action you want to assign.
- 4 If you want to add the action, click **Make Job Settings**. Click New, enter the **Job Description** and make the necessary Scan Settings, and then click **OK**.

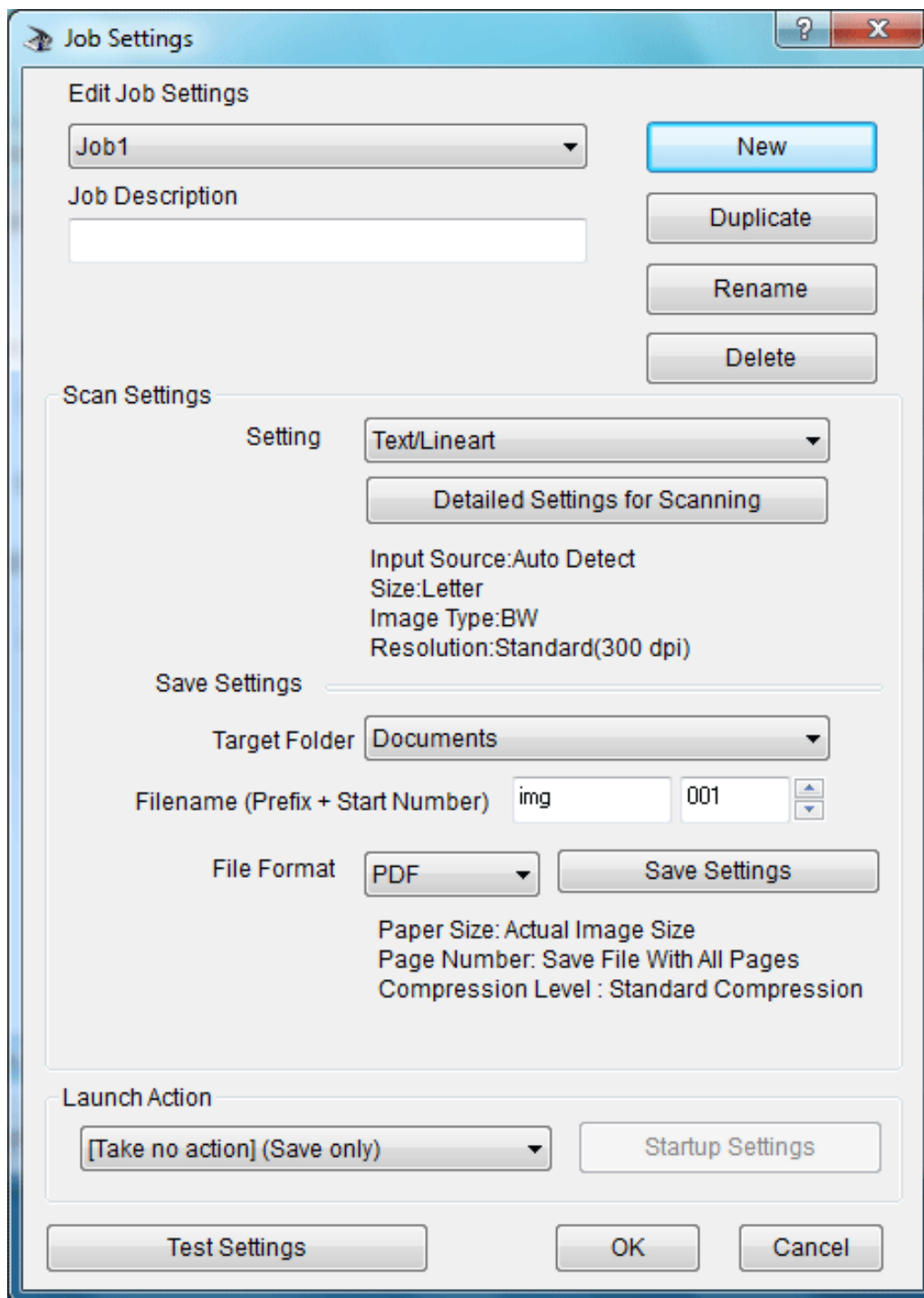

 **Note:**

After you finish the job settings, go back to step 3 and select the action you set.

- 5 Click **Close** to close the EPSON Event Manager window.

Now whenever you press the button you assigned, the action you selected opens.

 **Note:**

If you need help using EPSON Event Manager, do one of the following.
For Windows: Click the  icon in the upper right corner of the screen.
For Mac OS X: Click **Help** from menu, then **EPSON Event Manager Help**

Top 

Assigning a Program With Windows 7 and Vista

- 1 Click the  Start button icon and select **Control Panel**.
- 2 Click **Hardware and Sound**, then **Devices and Printers**.
- 3 Right-click your scanner's icon and select **Scan Properties** or **Properties**.
- 4 Click **Yes or Continue** in the User Account Control window.
- 5 Click the **Events** tab.

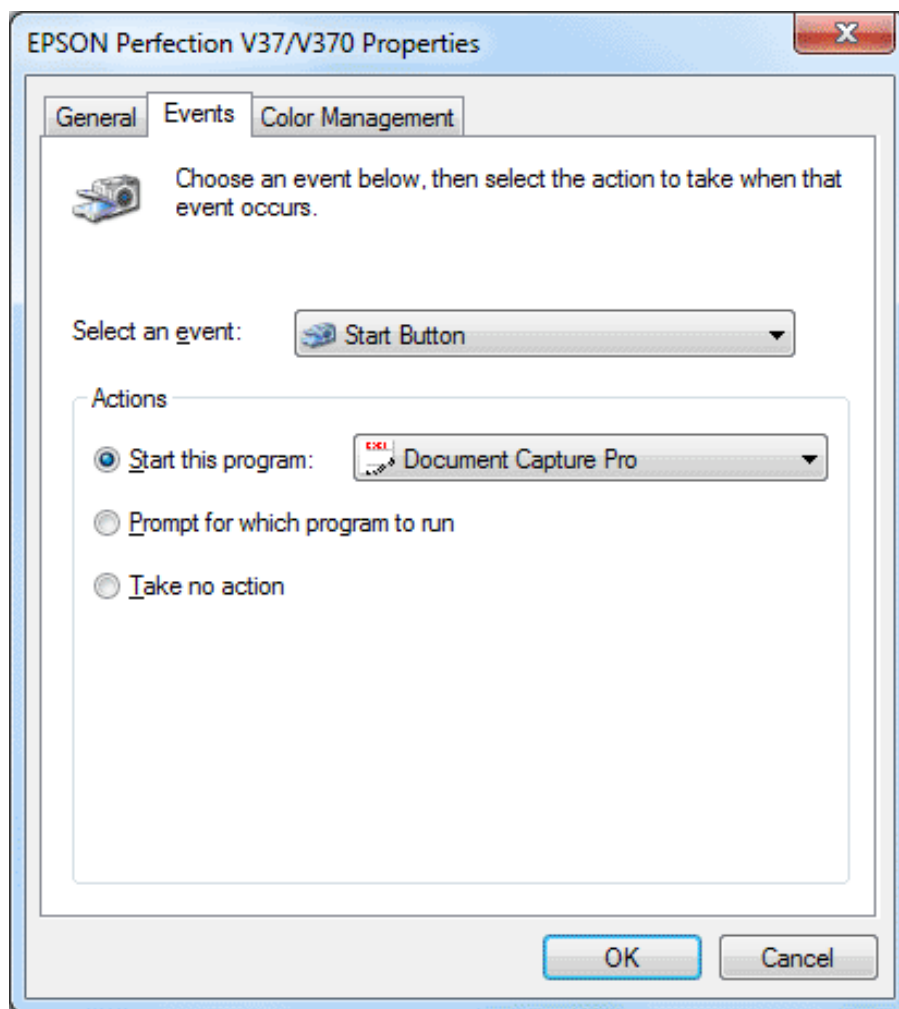

- 6 In the **Select an event** list, make sure **Start Button** is selected.

- 7 In the **Start this program** list, choose the program you want to assign. Only compatible programs appear in the list.

 **Note:**

If you want to be given a choice of programs whenever you press the  Start button, click the **Prompt for which program to run** radio button instead. If you want to disable the button from opening a program, click the **Take no action** radio button instead.

- 8 Click **OK**.

[Top](#) 

Assigning a Program With Windows XP

- 1 Click **Start > Control Panel > Printers and Other Hardware > Scanners and Cameras**.
- 2 Right-click your scanner's icon and select **Properties**.
- 3 Click the **Events** tab.
- 4 In the **Select an event** list, make sure **Start Button** is selected.
- 5 In the **Start this program** list, choose the program you want to assign. Only compatible programs appear in the list.

 **Note:**

If you want to be given a choice of programs whenever you press the  Start button, click the **Prompt for which program to run** radio button instead. If you want to disable the button from opening a program, click the **Take no action** radio button instead.

- 6 Click **Apply**, then click **OK**.

[Top](#) 

[Home](#) > [Scanning Special Projects](#)

■ Converting Scanned Documents Into Editable Text

You can scan a document and convert the text into a format data that you can edit with a word processing program. This process is called OCR (Optical Character Recognition). To scan and use OCR, you need to use an OCR program, such as the ABBYY FineReader program that came with your scanner.

OCR software cannot recognize or has difficulty recognizing the following types of documents or text.

- Handwritten characters
- Items that have been copied from other copies
- Faxes
- Text with tightly spaced characters or line pitch
- Text that is in tables or underlined
- Cursive or italic fonts, and font sizes less than 8 points

1 Place your document on the document table. See [Placing Documents or Photos](#) for details.

2 Do one of the following to start ABBYY FineReader:

Windows: Click the  Start button icon or **Start > Programs** or **All Programs > ABBYY FineReader 9.0 Sprint > ABBYY FineReader 9.0 Sprint**.



Mac OS X: Select **Applications** and double-click the **ABBYY FineReader 8.0 Sprint**.







You see the ABBYY FineReader window.

3 Follow the instructions in ABBYY FineReader Help.

■ Adjusting the Scanned Image

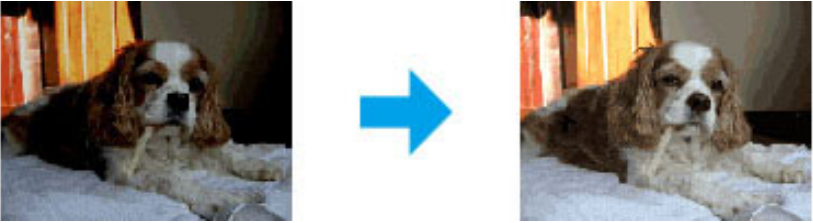
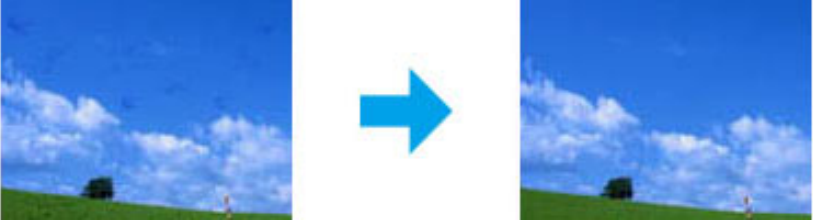
EPSON Scan offers a variety of settings for improving color, sharpness, contrast, and other aspects affecting image quality.

Histogram	<p>Provides a graphical interface for adjusting highlight, shadow, and gamma levels individually.</p>  A side-by-side comparison of a pink flower image. The left image is the original scan, and the right image is the result of histogram adjustment, showing improved contrast and color balance. A blue arrow points from the original to the adjusted image.
Tone Correction	<p>Provides a graphical interface for adjusting tone levels individually.</p>  A side-by-side comparison of a pink flower image. The left image is the original scan, and the right image is the result of tone correction, showing more vibrant and accurate colors. A blue arrow points from the original to the adjusted image.
Image Adjustment	<p>Adjusts brightness and contrast and the balance of red, green, and blue colors in the overall image.</p>  A side-by-side comparison of a basket of vegetables. The left image is the original scan, and the right image is the result of image adjustment, showing enhanced brightness and contrast. A blue arrow points from the original to the adjusted image.
Color Palette	<p>Provides a graphical interface for adjusting mid-tone levels, such as skin tones, without affecting the highlight and shadow areas of the image.</p>  A side-by-side comparison of a red maple leaf image. The left image is the original scan, and the right image is the result of color palette adjustment, showing more accurate and vibrant red tones. A blue arrow points from the original to the adjusted image.
Unsharp Mask	<p>Sharpens the edges of image areas for an overall clearer image.</p>  A side-by-side comparison of a red maple leaf image. The left image is the original scan, and the right image is the result of unsharp mask application, showing sharper edges and a clearer overall appearance. A blue arrow points from the original to the adjusted image.

<p>Descreening</p>	<p>Removes the rippled pattern that can appear in subtly shaded image areas such as skin tones.</p> 
<p>Color Restoration</p>	<p>Restores the colors in faded photos automatically.</p> 
<p>Backlight Correction</p>	<p>Removes shadows from photos that have too much background light.</p> 
<p>Dust Removal</p>	<p>Removes dust marks from your originals automatically.</p> 
<p>Text Enhancement</p>	<p>Enhances text recognition when scanning text documents.</p> 
<p>Auto Area Segmentation</p>	<p>Makes Black&White images clearer and text recognition more accurate by separating the text from the graphics.</p> 
<p>Dropout color</p>	<p>Scan without a certain color. You can select from red, blue, or green.</p> 

Color Enhance

Enhance a certain color. You can select from red, blue, or green.

scan your original documents in any of the available scanning m

scan your original documents in any of the available scanning m

Maintenance
Follow the guidelines here to m
transport your scanner.



Maintenance
Follow the guidelines here to m
transport your scanner.

Technical Specifications
Check here for technical details

Technical Specifications
Check here for technical details

See Epson Scan Help for details.

[Home](#) > [Maintenance](#)

Cleaning the Scanner

To keep your scanner operating at its best, clean it periodically using the following procedure.

 **Caution:**

- Do not press the glass surface of the document table with any force.
- Be careful not to scratch or damage the glass surface of the document table, and do not use a hard or abrasive brush to clean it. A damaged glass surface can decrease the scan quality.
- Never use alcohol, thinner, or corrosive solvent to clean the scanner. These chemicals can damage the scanner components and the case.
- Be careful not to spill liquid into the scanner mechanism or electronic components. This could permanently damage the mechanism and circuitry.
- Do not spray lubricants inside the scanner.
- Never open the scanner case.

- 1 Press the  Power button for 3 seconds to turn off the scanner.
- 2 Unplug the AC adapter cord from the scanner.
- 3 Clean the outer case with a cloth dampened with mild detergent and water.
- 4 If the glass surface of the document table gets dirty, clean it with a soft dry cloth. If the glass surface is stained with grease or some other hard-to-remove material, use a small amount of glass cleaner and on a soft cloth to remove it. Wipe off all remaining liquid.

 **Caution:**

Do not spray glass cleaner directly on the scanner glass.

- 5 Remove the document mat and clean the transparency unit window as described in step 4 (EPSON Perfection V370 Photo only).

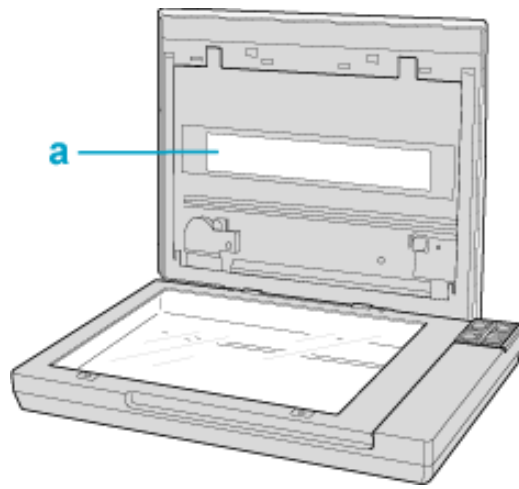

a. transparency unit window

Make sure that no dust builds up on the surface of the document table or the transparency unit window. Dust can cause spots in your scanned images.

[Home](#) > [Maintenance](#)

Transporting the Scanner

Before you transport the scanner for a long distance or store it for an extended period of time, the scanner's carriage needs to be in the home position to prevent damage.

- 1** Make sure the carriage is in the home position on the right side of the scanner. If the carriage is not in the home position, turn on the scanner and wait until the carriage moves to the home position.
- 2** Press the  Power button for 3 seconds to turn off the scanner, then unplug the AC adapter.
- 3** Disconnect the USB cable from the scanner.
- 4** Attach the packing materials that came with the scanner, then repack the scanner in its original box or a similar box that fits the scanner snugly.

[Home](#) > [Maintenance](#)

Power Off Timer Setting

The product turns off automatically if no operations are performed for the selected period. You can adjust the time before power management is applied. Any increase will affect the product's energy efficiency. Please consider the environment before making any change.

Follow the steps below to adjust the time.

- 1** Start EPSON Scan Settings.

Windows:

Start > **All Programs** or **Programs** > **EPSON** > **EPSON Scan** > **EPSON Scan Settings**

Mac OS X:

Select **Applications** > **EPSON Software** > **EPSON Scan Settings**.

- 2** Click **Power Off Timer**.





- 3** Adjust the Power Off Timer Setting as necessary, and then click **OK**.

Scanner Problems

- [The Status Light Is Flashing](#)
- [The Scanner Does Not Turn On](#)
- [The Scanner Does Not Turn Off](#)
- [The Scanner Turns Off](#)
- [You Cannot Start Epson Scan](#)
- [Pressing a Scanner Button Does Not Start the Correct Program](#)

The Status Light Is Flashing

The Status light is between the  Power/ Start button and the  scan to PDF button.

Color	Indicator Status	Meaning
Green	 On	Ready to scan images.
	 Flashing	Initializing or scanning.
Orange	 Flashing	<p>An error has occurred.</p> <ul style="list-style-type: none"> ▪ Make sure the scanner is connected to your computer properly. ▪ Make sure the scanner software is fully installed. See the Start Here sheet for instructions on installing the scanner software. ▪ Press the  Power button for 3 seconds to turn off the scanner, then turn it on again. If the Status light is still flashing orange, the scanner may be malfunctioning, or the scanner light source may need to be replaced. See Epson Technical Support for details.
(None)	 Off	The scanner is off.

Top 

The Scanner Does Not Turn On

- Make sure your scanner's AC adapter is securely connected to the scanner and a working electrical outlet.
- Make sure the electrical outlet works. If necessary, test it by plugging in another electrical device and turning it on.

Top 

The Scanner Does Not Turn Off

- Make sure you press the  Power button for 3 seconds to turn off the scanner.

- Make sure the scanning software is not running.

Top 

The Scanner Turns Off

- Make sure the Power Off Timer is set. This feature allows you to set the timer (number of minutes) for when to automatically shut down the scanner. For more details, see [Power Off Timer Setting](#).

Top 

You Cannot Start EPSON Scan

- Wait until the green status light stops flashing to indicate that the scanner is ready to scan.
- Make sure the scanner is turned on.
- Turn off the scanner and computer, then check the interface cable connection between them to make sure it is secure.
- Use the USB cable that came with your scanner or that is indicated in [USB Interface](#).

Note:

A USB cable is not bundled with the scanner in some areas.

- Connect the scanner directly to the computer's USB port or through one USB hub only. The scanner may not work properly when connected to the computer through more than one USB hub. If the problem persists, try connecting the scanner directly to the computer.
- Make sure your computer supports USB. See [Checking For Windows USB Support](#) for instructions.
- Make sure you select the correct scanner when starting to scan.
 - **For Windows:** When you start EPSON Scan using the  Start button or the EPSON Scan icon, and the Select Scanner list is displayed, make sure you select the model of your scanner.
 - **For Mac OS X:** When you start EPSON Scan from the EPSON Software folder in the Applications folder and the Select Scanner list is displayed, make sure you select your scanner model.
- If you are using any TWAIN-compliant program, such as ArcSoft MediaImpression, make sure that the correct scanner is selected as the Scanner or Source setting.
- If you are using any TWAIN-compliant application, the error may be occurring because the TWAIN-compliant application is currently unstable. Try using a different TWAIN-compliant application. If the problem persists, try restarting the computer.
- If you upgraded your computer's operating system, you need to reinstall EPSON Scan. Uninstall EPSON Scan as described in [Uninstalling Your Scanning Software](#), then reinstall it as described in the Start Here sheet.
- Make sure your computer and USB meets the system requirements. See [System Requirements](#) for details.

For Windows only:

Make sure your scanner's name appears under Imaging device without a (?) or an exclamation (!) mark in the Device Manager window. If the scanner's name appears with one of these marks or as an Unknown device, uninstall EPSON Scan as described in [Uninstalling Your Scanning Software](#), then reinstall it as described in the Start Here sheet.

Checking For Windows USB Support

- 1 Do one of the following:



Windows 7 and Vista: Click the **Start** button icon and select **Control Panel**.

Windows XP: Click **Start** and select **Control Panel**.

2 Do one of the following:

Windows 7: Click **System and Security** and then **System**.

Windows Vista: Click **System and Maintenance** and then **System**.

Windows XP: Click or double-click the **System** icon.

3 Do one of the following:

Windows 7: Click **Device Manager**.

Windows Vista: Click **Device Manager**, then click **Continue** in the User Account Control window.

Windows XP: Click the **Hardware** tab, then click **Device Manager**.

4 Scroll down and double-click **Universal Serial Bus controllers**.

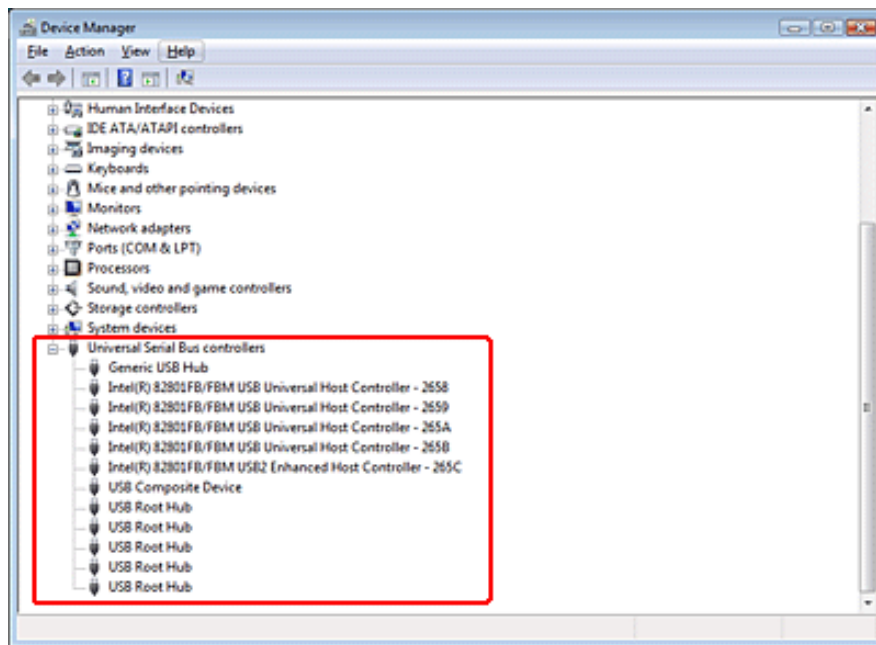

If a **USB Universal Host Controllers** and **USB Root Hub** are listed, Windows supports USB.

5 Try scanning again. If your scanner still is not recognized, contact Epson for assistance. See [Epson Technical Support](#).

Top

Pressing a Scanner Button Does Not Start the Correct Program

- Make sure EPSON Scan and EPSON Event Manager are installed correctly.
- Check if you have assigned a program to the scanner button. See [Assigning a Program to a Scanner Button](#) for details.
- **Mac OS X:** Make sure you are logged on as the user who installed the scanner software. Other users must first

start EPSON Scanner Monitor in the Epson Software folder in the Applications folder and then press a button to scan.

[Top](#) 

■ Scanning Problems

- ▾ You Cannot Scan Using the Thumbnail Preview
- ▾ You Have Trouble Adjusting the Scan Area in the Thumbnail Preview
- ▾ Negative Film Preview Images Look Strange (EPSON Perfection V370 Photo only)
- ▾ You Cannot Scan Multiple Images at One Time
- ▾ You Cannot Scan in Full Auto Mode
- ▾ Scanning Takes a Long Time
- ▾ You Cannot Scan Film or Slides (EPSON Perfection V370 Photo only)

You Cannot Scan Using the Thumbnail Preview

- If you are using Full Auto Mode and Office Mode, the thumbnail preview is not available. Change the scan mode to Home Mode or Professional Mode. See [EPSON Scan Mode](#) for details.
- If you are scanning images with a very dark or bright background, use normal preview and create marquees on the area you want to scan. See the EPSON Scan help for details.
- If you are scanning a film strip including both panoramic and regular size images, the panoramic images are not previewed. For the panoramic images, use normal preview and create marquees on the area you want to scan. See the EPSON Scan help for details.
- If you are scanning a large size document, use normal preview and create marquees on the area you want to scan. See the EPSON Scan help for details.
- Make sure the **Document Type** setting (Home Mode) or **Document Type** and **Film Type** setting (Professional Mode) are correct.
- Click **Configuration**, select the **Preview** tab, and adjust the thumbnail cropping area using the **Thumbnail Cropping Area** slider.
- If you are scanning in Home Mode and Illustration, Magazine, Newspaper or Text/Line Art is selected as Document Type, thumbnail preview is not available.

Top 

You Have Trouble Adjusting the Scan Area in the Thumbnail Preview

- Create a marquee or adjust the existing marquee to select the area you want to scan. See the EPSON Scan help for details.
- Click **Configuration**, select the **Preview** tab, and adjust the thumbnail cropping area using the **Thumbnail Cropping Area** slider.
- Use the normal preview and create marquees on the area you want to scan. See the EPSON Scan help for details.

Top 

Negative Film Preview Images Look Strange (EPSON Perfection V370 Photo only)

- Make sure the **Document Type** setting (Home Mode) or **Film Type** settings (Professional Mode) are set correctly

for your film.

- If you are in normal preview, the dark area around the film and the frame of the film holder is perceived as white. This alters the exposure and causes images to appear darker. Create marquees on the image area you want to scan, then click **Zoom** to preview the area. See the EPSON Scan help for details.
- Use thumbnail preview instead of normal preview. See the EPSON Scan help for details.

Top 

You Cannot Scan Multiple Images at One Time

Position photos at least 20 mm (0.8 inch) apart from each other on the document table.

Top 

You Cannot Scan in Full Auto Mode

- If you are scanning images with a very dark or bright background, switch to Office Mode, Home Mode, or Professional Mode. To change the scan mode, see [EPSON Scan Mode](#). Then, use normal preview and create marquees on the area you want to scan.
- If you are scanning a large size document, such as A4, switch to Office Mode, Home Mode, or Professional Mode. To change the scan mode, see [EPSON Scan Mode](#). Then, use normal preview and create marquees on the area you want to scan.

Top 

Scanning Takes a Long Time

- Try scanning your original at a lower resolution setting to speed up scanning. See EPSON Scan Help for details.
- Computers with USB 2.0 (high speed) ports can scan faster than those with USB 1.1 ports. If you are using a USB 2.0 port with your scanner, make sure it meets the system requirements. See [System Requirements](#) for details.

Top 

You Cannot Scan Film or Slides (EPSON Perfection V370 Photo only)

- Make sure the document mat is removed from the scanner cover. See [Removing the Document Mat](#) for details.
- Make sure your film or slides are placed in the film holder correctly and the film holder is properly positioned on the document table. See [Placing Film or Slides \(EPSON Perfection V370 Photo Only\)](#) for details.
- Make sure the **Document Type** setting (Home Mode) or **Film Type** settings (Professional Mode) are set correctly for your film/slide type.

Top 

Scan Quality Problems

- ▾ The Edges of Your Original Are Not Scanned
- ▾ You See Only a Few Dots in Your Scanned Image
- ▾ A Line or Line of Dots Always Appears in Your Scanned Images
- ▾ Straight Lines in Your Image Come Out Crooked
- ▾ Your Image Is Distorted or Blurred
- ▾ Colors Are Patchy or Distorted at the Edges of Your Image
- ▾ Your Scanned Image Is Too Dark
- ▾ An Image on the Back of Your Original Appears in Your Scanned Image
- ▾ Ripple Patterns Appear in Your Scanned Image
- ▾ Characters Are Not Recognized Well When Converted into Editable Text (OCR)
- ▾ Scanned Colors Differ From the Original Colors
- ▾ Striped Rings Appear in Your Scanned Image of Film or Slides Images (EPSON Perfection V370 Photo only)
- ▾ Images are Rotated Incorrectly

The Edges of Your Original Are Not Scanned

- If you are scanning in Full Auto Mode, or using thumbnail preview in Home Mode or Professional Mode, move the document or photo about 6 mm (0.2 inch) away from the horizontal (b) and vertical (a) edges of the document table to avoid cropping.
- If you are scanning using normal preview in Office Mode, Home Mode, or Professional Mode, move the document or photo about 3 mm (0.12 inch) away from the horizontal (b) and vertical (a) edges of the document table to avoid cropping.

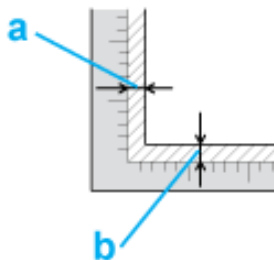

Top

You See Only a Few Dots in Your Scanned Image

- Make sure the document or photo is placed on the document table with the side to be scanned facing down. See [Placing Documents or Photos](#) for details.
- Check the scanning software settings, such as image type and resolution..

Top

A Line or Line of Dots Always Appears in Your Scanned Images

The document table or transparency unit window may need cleaning. Clean the document table. See [Cleaning the Scanner](#).

If you still have the problem, the document table or transparency unit window may be scratched. Contact Epson for assistance.

[Top](#) 

Straight Lines in Your Image Come Out Crooked

Make sure the document lies perfectly straight on the document table.

[Top](#) 

Your Image Is Distorted or Blurred



- Make sure the document or photo lies flat on the document table. Also make sure your document or photo is not wrinkled or warped.
- Make sure you do not move the document or photo, or your scanner while scanning.
- Make sure the scanner is placed on a flat, stable surface.
- Check the scanning software settings, such as resolution and image adjustment.

[Top](#) 

Colors Are Patchy or Distorted at the Edges of Your Image



If your document is very thick or curled at the edges, cover the edges with paper to block external light as you scan.

Your Scanned Image Is Too Dark





- If your original is too dark, try using the **Backlight Correction** feature in Home Mode or Professional Mode. See EPSON Scan Help for details.
- Check the **Brightness** setting in Office Mode, Home Mode, or Professional Mode. See EPSON Scan Help for details.
- Click **Configuration**, select the **Color** tab, and change the **Display Gamma** setting to match your output device, such as a monitor or printer. See EPSON Scan Help for details.
- Click **Configuration**, select the **Color** tab, and select **Color Control** and **Continuous auto exposure**. See EPSON Scan Help for details.
- Click **Configuration**, select the **Color** tab, and click **Recommended Value** to return the Auto Exposure setting to the default. See EPSON Scan Help for details.
-  Click the Histogram Adjustment icon in Professional Mode to adjust the brightness.
- Check the brightness and contrast settings of your computer monitor.

An Image on the Back of Your Original Appears in Your Scanned Image

If your original is printed on thin paper, images on the back may be visible to the scanner and appear in your scanned image. Try scanning the original with a piece of black paper placed on the back of it. Also check the scanning software settings such as image type and image adjustment. [Top !\[\]\(0aff635c4179ba9e710b00f4b01d3b20_img.jpg\)](#)

Ripple Patterns Appear in Your Scanned Image

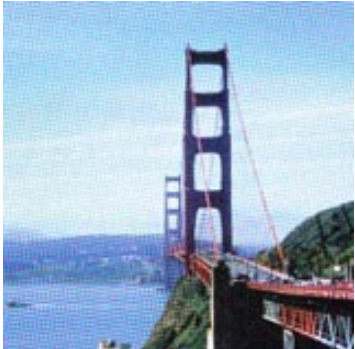
A ripple or cross-hatch pattern (called moiré) may appear in a scanned image of a printed document. It is caused by interference from the differing pitches in the scanner's screen and the halftone screen in your original.

Original image	Descreening applied
 <p style="text-align: center;">Off</p>	 <p style="text-align: center;">On</p>

- Select the **Descreening** check box in Office Mode, Home Mode, or Professional Mode. In Professional Mode, select an appropriate **Screen Ruling** for the Descreening and deselect the **Unsharp Mask** setting in EPSON Scan. See EPSON Scan help for details.
- Select a lower resolution setting. See the scanning software help for details.

 **Note:**

You cannot remove ripple patterns when you are scanning film or monochrome images, or scanning using a resolution higher than 600 dpi.

Top 

Characters Are Not Recognized Well When Converted into Editable Text (OCR)

- Make sure the document lies perfectly straight on the document table.
- Try the skew correction function. See the scanning software help for details.
- Check your OCR software manual to see if there are any settings you can adjust in your OCR software.

Top 

Scanned Colors Differ From the Original Colors

- ■ Scan quality can be improved by changing the current settings or adjusting the scanned image. See [Adjusting the Scanned Image](#)
- Check the color matching and color management capabilities of your computer, display adapter, and software. Some computers can change the palette of colors on your screen. See your software and hardware manuals for details.
- Use the color management system for your computer: ICM for Windows, or ColorSync for Macintosh. Add a color profile that matches your monitor to improve on-screen color matching. Exact color matching is very difficult. Check your software and monitor documentation for information on color matching and calibration.
- Printed colors can never exactly match the colors on your monitor because printers and monitors use different color systems: monitors use RGB (red, green, and blue) and printers typically use CMYK (cyan, magenta, yellow, and black).

Top 

Striped Rings Appear in Your Scanned Image of Film or Slides Images (EPSON Perfection V370 Photo only)

A ring-shaped pattern of stripes (called a Newton ring) sometimes appears on scanned images of transparent materials. This may occur if the film is curled.

Top 

Images are Rotated Incorrectly

- ■ Make sure the documents or photos are placed on the document table correctly. See [Placing Documents or](#)

[Photos](#) for details.

- Make sure the film or slides are placed in the film holder correctly and the film holder is properly positioned on the document table. See [Placing Film or Slides \(EPSON Perfection V370 Photo Only\)](#) for details.
- Rotate the images. See the scanning software help for details.

[Top](#) 

[Home](#) > [Solving Problems](#)

■ Uninstalling Your Scanning Software

 [For Windows](#)

 [For Mac OS X](#)

You may need to uninstall and then reinstall your scanner software to solve certain problems or if you upgrade your operating system.

For Windows



Note:

- For Windows 7 and Vista, you need an administrator account and password if you log on as a standard user.
- For Windows XP, you must log on to a Computer Administrator account.

- 1 Turn off the scanner.
- 2 Disconnect the scanner's interface cable from your computer.
- 3 Do one of the following.
Windows 7 and Vista: Click the start button and select **Control Panel**.
Windows XP: Click **Start** and select **Control Panel**.
- 4 Do one of the following.
Windows 7 and Vista: Click **Uninstall a program** from the Programs category.
Windows XP: Double-click the **Add or Remove Programs** icon.
- 5 Select the software you want to uninstall such as EPSON Scan, your scanner's Manual, or an application from the list displayed.
- 6 Do one of the following.
Windows 7: Click **Uninstall/Change**.
Windows Vista: Click **Uninstall/Change**, and then click **Continue** in the User Account Control window.
Windows XP: Click **Change/Remove**.
- 7 When the confirmation window appears, click **Yes**.
- 8 Follow the on-screen instructions.

In some cases, a message may appear to prompt you to restart your computer. If so, make sure **I want to restart my computer now** is selected and click **Finish**.

Top 

For Mac OS X

In most cases, you do not need to uninstall your product software before reinstalling it. However, you can download the Uninstall Center utility from the Epson support website to uninstall your product software as described here.

Note:

■ If you find that reinstalling your product software does not solve a problem, contact Epson.

- 1 To download the Uninstall Center utility, visit the Epson download site ([U.S. downloads](#) or [Canadian downloads](#)).
- 2 Follow the instructions on the screen to install the Uninstall Center.
- 3 Quit all applications currently running on your Mac.
- 4 Double click the **Uninstall Center** icon.
- 5 Select the checkbox for each software program you want to uninstall.
- 6 Click **Uninstall**.
- 7 Follow the on-screen instructions to uninstall the software.

Top 

[Home](#) > [Solving Problems](#)

■ EPSON Technical Support

-  [Internet Support](#)
-  [Speak to a Support Representative](#)
-  [Purchase Accessories](#)

Internet Support

Visit Epson's support website at www.epson.com/support (U.S.) or www.epson.ca/support (Canada) and select your product for solutions to common problems. You can download drivers and documentation, get FAQs and troubleshooting advice, or e-mail Epson with your questions.

[Top](#) 

Speak to a Support Representative

Before you call Epson for support, please have the following information ready:

- Product name
- Product serial number (located on a label on the product)
- Proof of purchase (such as a store receipt) and date of purchase
- Computer configuration
- Description of the problem

Then call:

- U.S.: (562) 276-4382, 6 AM to 8 PM, Pacific Time, Monday through Friday, and 7 AM to 4 PM, Pacific Time, Saturday
- Canada: (905) 709-3839, 6 AM to 8 PM, Pacific Time, Monday through Friday, and 7 AM to 4 PM, Pacific Time, Saturday

Days and hours of support are subject to change without notice. Toll or long distance charges may apply.

 **Note:**

For help using any other software on your system, see the documentation for that software or [Other Software Technical Support](#).

[Top](#) 

Purchase Accessories

You can purchase genuine EPSON accessories from an EPSON authorized reseller. To find the nearest reseller, call 800-GO-EPSON (800-463-7766). Or you can purchase online at www.epsonstore.com (U.S. sales) or www.epson.ca

(Canadian sales).

[Top](#) 

[Home](#) > [Solving Problems](#)

■ Other Software Technical Support

ABBYY FineReader

(408) 457-9777, www.abbyy.com, support@abbyyusa.com

ArcSoft Medialmpression and Scan-n-Stitch Deluxe

(510) 979-5599 (installation issues only), (510) 979-5555 (technical issues; fee applies), www.arcsoft.com

[Home](#) > [Technical Specifications](#)

■ System Requirements

[Windows System Requirements](#)

[Macintosh System Requirements](#)

Make sure your system meets the requirements in these sections before using it with your scanner.

Windows System Requirements

System	Microsoft Windows 7, Windows Vista, Windows XP Home Edition, Windows XP Professional Edition, Windows XP Professional x64 Edition (Operating systems upgraded from Windows Millennium Edition, 98, or 95 are not supported by the software.) USB 2.0 Host Driver by Microsoft must be used.
Interface	USB port (Type A) built into the main board
Display	Color monitor with 800 × 600 screen resolution or higher, and 24-bit (Full Color) color (Color and tone reproduction are subject to the display capability of your computer system, including the video card, display monitor, and software. See your system documentation for details.)

[Top](#) 

Macintosh System Requirements



System	Macintosh computers running Mac OS X 10.5.8, 10.6.x, 10.7.x, or 10.8.x. Fast User Switching on Mac OS X or later is not supported.
Interface	Macintosh USB
Display	Color monitor with 800 × 600 screen resolution or higher, and millions of colors (Color and tone reproduction are subject to the display capability of your computer system, including the video card, display monitor, and software. See your system documentation for details.)

 **Note:**

EPSON Scan does not support the UNIX File System (UFS) for Mac OS X. You must install EPSON Scan on a disk or in a partition that does not use UFS.

[Top](#) 

Scanner Specifications

-  General
-  Mechanical
-  Electrical
-  Environmental
-  Interfaces
-  Standards and Approvals

 **Note:**

Specifications are subject to change without notice.

General

Scanner type	Flatbed color
Photoelectric device	Color CCD line sensor
Effective pixels	40,800 × 56,160 pixels at 4800 dpi Scanning area may be restricted if resolution setting is large.
Document size	Reflective: 8.5 × 11.7 inches (216 × 297 mm) US letter or A4 size Transparent: 35 mm film strip: 6 frames at a time 35 mm slides: up to 4 slides at a time
Scanning resolution	4800 dpi (main scan) 9600 dpi with Micro Step (sub scan)
Output resolution	50 to 6400, 9600, and 12800 dpi (50 to 6400 dpi in 1 dpi increments)
Image data	16 bits per pixel per color internal 16 bits per pixel per color external (maximum)
Interface	One USB 2.0 Hi-speed port
Light source	White LED

 **Note:**

Optional optical resolution is the maximum scan resolution of the CCD elements, using the definition of ISO 14473. ISO 14473 defines optical resolution as the fundamental sampling rate of the scan sensor.

Mechanical

EPSON Perfection V37

Dimensions	Width: 16.9 inches (430.0 mm) Depth: 11.0 inches (280.0 mm) Height: 1.6 inches (40.8 mm)
Weight	Approx. 4.9 lb (2.2 kg)

EPSON Perfection V370 Photo

Dimensions	Width: 16.9 inches (430.0 mm) Depth: 11.0 inches (280.0 mm) Height: 2.6 inches (66.5 mm)
Weight	Approx. 6.2 lb (2.8 kg)

[Top](#) 

Electrical



Note:

Check the label on the AC adapter or on the back of the scanner for voltage information.

Scanner

Rated voltage	DC 13.5 V
Rated input current	1.2 A
Power consumption	12.0 W Operating 5.5 W Ready Mode 2.9 W Sleep Mode 0.5 W Power off

AC Adapter

	100-120 V model	220-240 V model
AC adapter model	A392 UC	A392 GB A392 VD A392 AS A392 BS A392 KR A392 AR
Rated input voltage	AC 100 to 120 V	AC 220 to 240 V
Rated input current	0.5 A	0.3 A
Rated input frequency	50 to 60 Hz	

Rated output voltage	DC 13.5 V
Rated output current	1.2 A

 **Note:**

The AC adapter model varies in certain locations.

[Top](#) 

Environmental

Temperature	Operating	10 to 35 °C (50 to 95 °F)
	Storage	-25 to 60 °C (-13 to 140 °F)
Humidity	Operating	10 to 80%, without condensation
	Storage	10 to 85%, without condensation
Operating conditions		Ordinary office or home conditions. Avoid operating the scanner in direct sunlight, near a strong light source, or in extremely dusty conditions.

[Top](#) 

Interfaces

USB Interface

Interface type	Universal Serial Bus Specification Revision 2.0
Electrical standard	Full Speed mode (12 Mbits per second) and Hi-Speed mode (480 Mbits per second) of Universal Serial Bus Specification Revision 2.0.
Connector type	One Type B port

[Top](#) 

Standards and Approvals

Scanner

EMC	FCC Part 15 Subpart B Class B CAN/CSA-CEI/IEC CISPR22 Class B
-----	--

AC Adapter

Safety	UL60950-1 CAN/CSA-C22.2 No. 60950-1
EMC	FCC Part 15 Subpart B Class B CAN/CSA-CEI/IEC CISPR22 Class B

[Top](#) 