



ThinkCentre

ThinkCentre Tiny-in-One 22 User Guide



Product number

10LK-PAR6-WW



First Edition (Mar 2016)

© Copyright Lenovo 2016. All rights reserved.

LENOVO products, data, computer software, and services have been developed exclusively at private expense and are sold to -governmental entities as commercial items as defined by 47 C.F.R. 2.101 with limited and restricted rights to use, reproduction and -disclosure. LIMITED AND RESTRICTED RIGHTS NOTICE: IF products, data, computer software, or services are delivered pursuant a -General Services Administration "GSA" contract, use, reproduction, or disclosure is subject to restrictions set forth in Contract No. -GS-35F-05925.

Contents

Product number	i
Contents.....	ii
Safety information.....	iii
Safety and maintenance guidelines	iv
Chapter 1 Getting started	1
Shipping contents	1
Locating connectors and controls on your monitor.....	2
Setting up your monitor.....	3
Chapter 2 Adjusting and using your monitor.....	9
Adjusting the full-function monitor stand	9
Installing the monitor driver	10
Comfort and accessibility.....	10
Arranging your work area	10
Quick tips for healthy work habits.....	11
Accessibility information	11
Adjusting your monitor image.....	12
Using the user controls.....	12
Using the OSD controls	12
Using the USB connectors.....	13
Using the audio.....	13
Selecting a supported display mode.....	16
Understanding power management.....	16
Caring for your monitor	17
Chapter 3 Reference information.....	18
Disassembling your monitor	18
Monitor specifications	21
Troubleshooting.....	22
Manual image setup	23
Manually installing the monitor driver	24
Service information	28
Appendix A Service and support	29
Registering your option	29
Online technical support	29
Telephone technical support	29
Worldwide telephone list	29
Appendix B Notices	33
Recycling information	34
Collecting and recycling a disused Lenovo computer or monitor.....	34
Disposing of Lenovo computer components	34
Turkish statement of compliance.....	35
Trademarks	35

Safety information

General Safety guidelines

For safety tips about using your monitor, go to:
<http://www.lenovo.com/safety> Before installing this product,
read the Safety Information.

مج، يجب قراءة دات السلامة

Antes de instalar este produto, leia as Informações de Segurança.

在安装本产品之前，请仔细阅读 **Safety Information**
(安全信息)。

Prije instaliranja ovog proizvoda obavezno pročitajte sigurnosne upute.

Před instalací tohoto produktu si přečtěte příručku bezpečnostních instrukcí.

Læs sikkerhedsforskrifterne, før du installerer dette produkt.
Ennen kuin asennatt ämän tuotteen, lue turvaohjeet kohdasta Safety Information.
Avant d'installer ce produit, lisez les consignes de sécurité.
Vor der Installation dieses Produkts die Sicherheitshinweise lesen.

Πριν εγκαταστήσετε το προϊόν αυτό, διαβάστε τις πληροφορίες ασφάλειας
(safety information).

לפני שתתקינו מוצר זה, קראו את הוראות הבטיחות.

A termék telepítése előtt olvassa el a Biztonsági előírásokat!

Prima di installare questo prodotto, leggere le Informazioni sulla Sicurezza.

製品の設置の前に、安全情報をお読みください。

본 제품을 설치하기 전에 안전 정보를 읽으십시오.

Пред да се инсталира овој продукт, прочитајте информацијата за безбедност.

Lees voordat u dit product installeert eerst de veiligheidsvoorschriften.
Les sikkerhetsinformasjonen (Safety Information) før du installerer dette produktet.

Przed zainstalowaniem tego produktu, należy zapoznać się
z książką "Informacje dotyczące bezpieczeństwa" (Safety Information).

Antes de instalar este produto, leia as Informações sobre Segurança.

Перед установкой продукта прочтите инструкции по
технике безопасности.

Pred inštaláciou tohto produktu si prečítajte bezpečnostné informácie.

Pred namestitvijo tega proizvoda preberite Varnostne informacije.

Antes de instalar este producto lea la información de seguridad.
Läs säkerhetsinformationen innan du installerar den här produkten.

សូមអានព័ត៌មានល្អិតល្អន់ មុនពេលចាប់ផ្តើមបញ្ចូលកម្មវិធី

安裝本產品之前，請先閱讀「安全資訊」。

Safety and maintenance guidelines

Important Safety Information

The power cord is designed for use with your monitor. Don't use a different cord, use only a power source and connection compatible with this monitor.



WARNING: Always connect your monitor, the computer, and other equipment to a grounded (earthed) power outlet. To reduce the risk of electric shock or damage to your equipment, do not disable the power cord grounding feature. The grounding plug is an important safety feature.



WARNING: For your safety, be sure that the grounded power outlet you plug the power cord into is easily accessible to the operator and located as close to the equipment as possible. To disconnect power from the equipment, unplug the power cord from the power outlet by grasping the plug firmly. Never pull on the cord.



CAUTION: To protect your monitor, as well as your computer, connect all power cords for your computer and its peripheral devices (such as a monitor, printer, or scanner) to a surge protection device such as a power strip with surge protection or uninterruptible power supply (UPS). Not all power strips provide surge protection; the power strips must be specifically labelled as having this ability. Use a power strip whose manufacturer offers a damage replacement policy, so you can replace your equipment if surge protection fails.



CAUTION: A certified power supply cord has to be used with this equipment. The relevant national installation and/or equipment regulations shall be considered. A certified power supply cord not lighter than ordinary polyvinyl chloride flexible cord according to IEC 60227 (designation H05VV-F 3G 0.75mm² or H05VVH2-F2 3G 0.75mm²) shall be used. An alternative flexible cord is synthetic rubber.

Safety Precautions

- Use only a power source and connection compatible with this monitor, as indicated on the label/back plate of the monitor.
- Be sure the total ampere rating of the products connected to the outlet does not exceed the current rating of the electrical outlet, and the total ampere rating of the products connected to the power cord does not exceed the rating of the power cord. Look on the power label to determine the ampere rating (Amps or A) for each device.
- Install your monitor near a power outlet that you can easily reach. Disconnect the monitor by grasping the plug firmly and pulling it from the outlet. Never disconnect the monitor by pulling the cord.
- Do not allow anything to rest on the power cord. Do not walk on the cord.
- While using VESA mount application, the AC Inlet must face to down side. Do not face any other position.

Maintenance Guidelines

To enhance the performance and extend the life of your monitor:

- Do not open your monitor cabinet or attempt to service this product yourself. If your monitor is not operating properly or has been dropped or damaged, contact your Lenovo® authorized dealer, reseller, or service provider.
- Adjust only those controls that are described in the operating instructions.
- Turn your monitor off when not in use. You can substantially increase the life expectancy of the monitor by using a screen saver program and turning off the monitor when not in use.
- Keep your monitor in a well-ventilated area, away from excessive light, heat, or moisture.
- Slots and openings in the cabinet are provided for ventilation. These openings must not be blocked or covered. Never push objects of any kind into cabinet slots or other openings.
- Unplug the monitor from the power outlet before cleaning. Do not use liquid cleaners or aerosol cleaners.
- Do not drop the monitor or place it on an unstable surface.
- When removing the monitor base, you must lay the monitor face down on a soft area to prevent it from getting scratched, defaced, or broken.

Cleaning the Monitor

The monitor is a high-quality optical device that requires special care when cleaning. To clean the monitor, follow these steps:

1. Turn off the computer and the monitor.
2. Unplug your monitor from the power outlet before cleaning.



CAUTION: Do not use benzene, thinner, ammonia, or any volatile substance to clean the monitor screen or cabinet. These chemicals may damage the monitor. Do not use liquid or aerosol cleaners. Never use water to clean an LCD screen.

3. Wipe the screen with a dry, soft, clean cloth. If the screen requires additional cleaning, use an antistatic screen cleaner.
4. Dust the monitor housing. Use a damp cloth to clean the cabinet. If the cabinet requires additional cleaning, use a clean cloth dampened with isopropyl alcohol.
5. Plug in the monitor.
6. Turn on the monitor and the computer.

Chapter 1 Getting started

This User Guide contains detailed information on the Lenovo ThinkCentre® Tiny-in-One 22 Monitor. For a quick overview, please see the Setup Poster that was shipped with your monitor.

Shipping contents

The product package should include the following items:

- ac power adapter
- Flat panel monitor
- Information flyer
- Monitor stand
- Monitor base
- Power cord
- Reference and driver CD

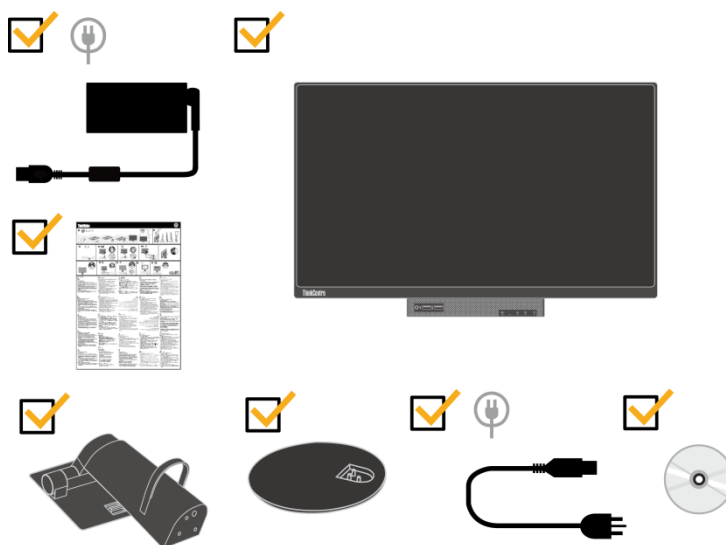

***Your monitor supports the following Tinsys that can be installed in your monitor:

- M53, M73, M83, M93
- M600, M700, M900
- ThinkCentre Chromebox

Before you install your Tiny into your monitor, ensure that the Tiny is listed above.

***Turning on your monitor and Tiny computer

1. Install your computer into the Tiny-In-One 22.
2. Connect a Lenovo keyboard to USB port 3 on the rear of the computer. (See Figure 1)
3. Press ALT+P on the keyboard to power on the computer and Tiny-In-One 22.

Note: ThinkCentre M53, M83, M600, M700, M900, Chromebox Tiny may also be powered on with the Tiny-In-One 22 power button. (See Figure 2)

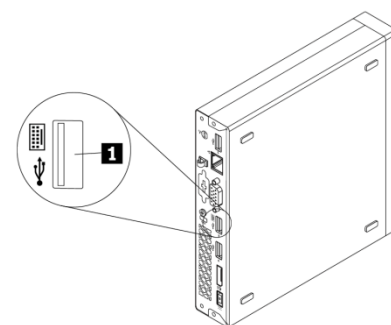

(1)

	ALT-P	
ThinkCentre M53,M83	√	√
ThinkCentre M600,M700,M900	√	√
ThinkCentre Chromebox	×	√
ThinkCentre M73,M93	√	×

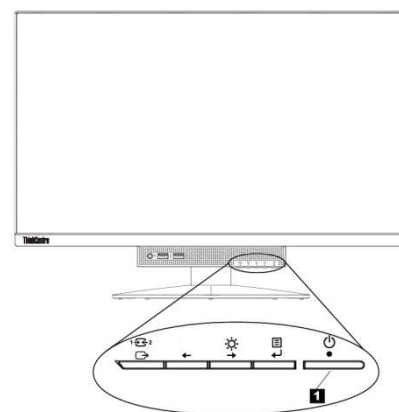

(2)

Locating connectors and controls on your monitor

Front view

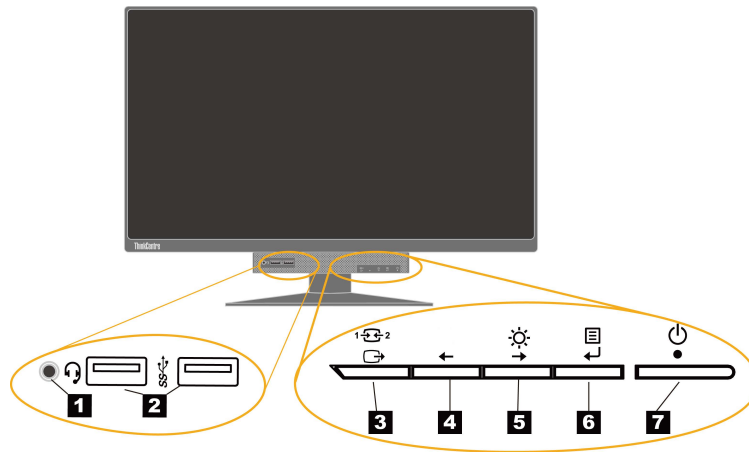

1 Headset connector	2 USB 3.0 connectors (2)
3 Mode-switching button / Back button	4 Left shift button
5 Brightness control / Right shift button	6 Selection button / Menu-opening button
7 Power button	

Rear view

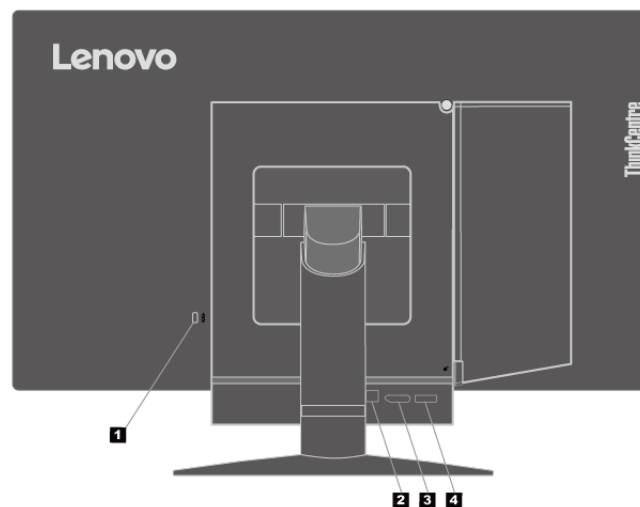

1 Security-lock slot	2 USB 3.0 upstream connector
3 DisplayPort® connector	4 ac power adapter connector

Setting up your monitor

This section provides the following information:

- Assembling your monitor
- Connecting cables
- Turning on your monitor and computer

Note: Before setting up your monitor, ensure that you have read and understood the “Safety information” on page iii.

Assembling your monitor

To assemble your monitor, follow the four parts below one by one:

Part 1: Install the full-function monitor stand.

Part 2: Install the Tiny.

Part 3: Install the rear Wi-Fi antenna (optional).

Part 4: Install the Kensington-style cable lock (optional).

Part 1: Install the full-function monitor stand.

Note: The full-function monitor stand includes one monitor stand and one stand base.

1. Place a soft, clean towel or cloth on the desk or surface. Hold the sides of your monitor and gently lay it down so that the screen is against the surface and the cover is facing up.
2. Insert the three metal studs on the base into the corresponding holes in the stand. Then, tighten the screw as shown to secure the stand.

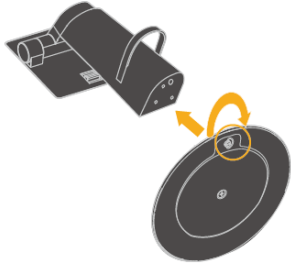

3. Insert the two metal tabs on the stand into the corresponding holes on the rear of the monitor. Then, pivot the stand downward until it clicks into position.

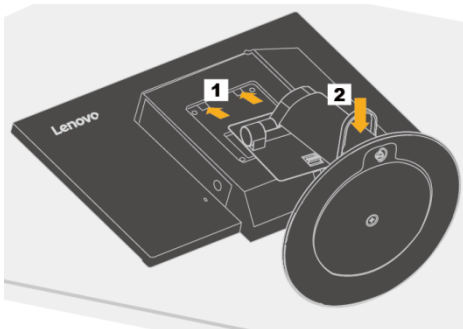

Part 2: Install the Tiny.

1. Press the decorative cover 1 as shown to remove it. Then, press the button 2 to open the cable cover.

Note: Keep the decorative cover for future use.

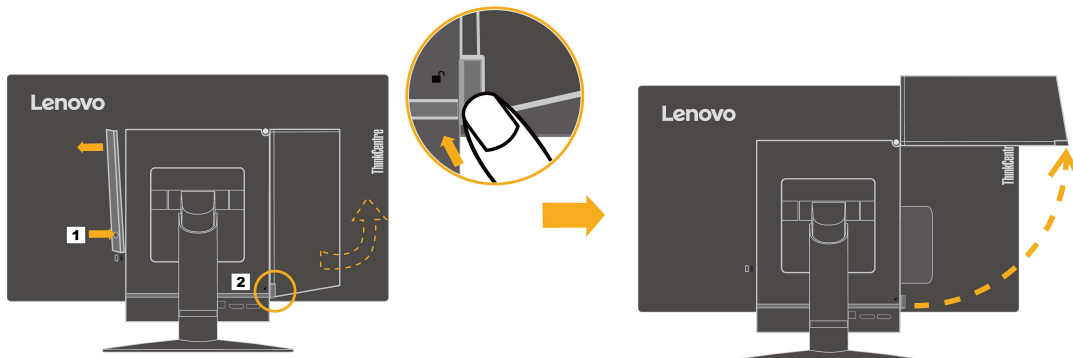

2. With the Lenovo logo facing you, insert your Tiny into the computer bay until it rests on the stoppers.

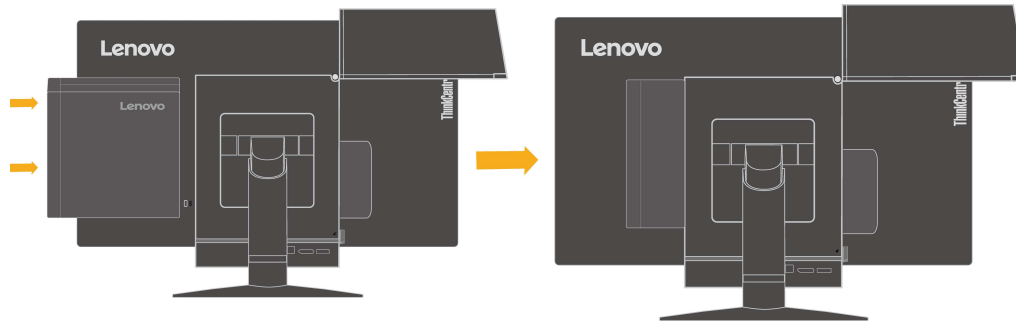

3. Press the computer from the front until it completely snaps into position.

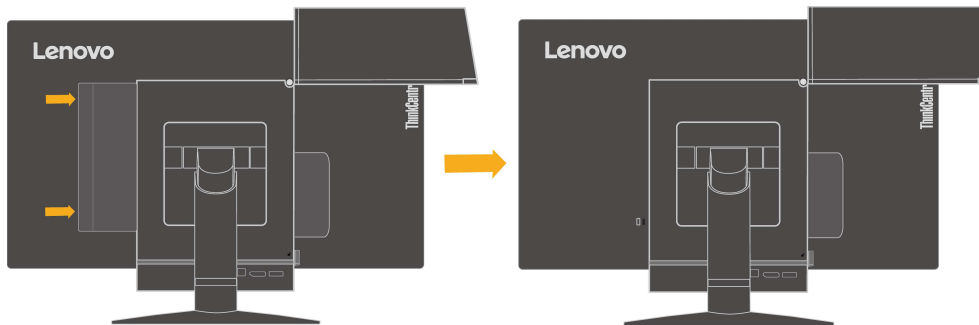

Note: Make sure the Tiny is aligned with the back cover.

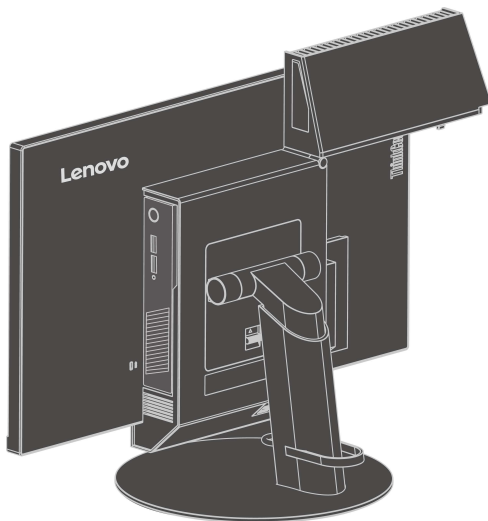

4. Tighten the screw to secure the Tiny.

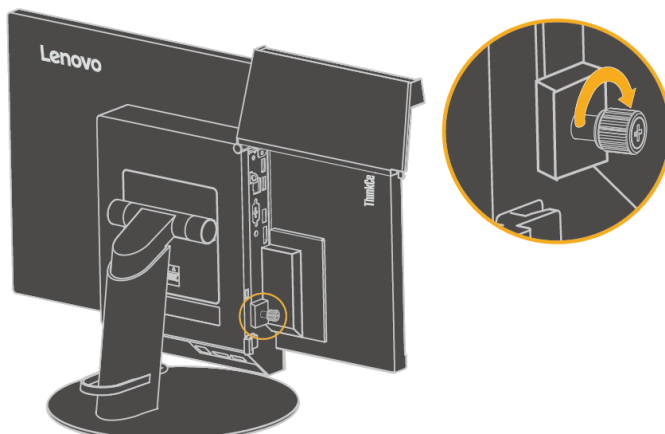

Part 3: Install the rear Wi-Fi antenna (optional).

1. Pivot the cable cover as shown to the open position. Then, press the decorative cover 2 from the inner side of the cable cover to remove the decorative cover.

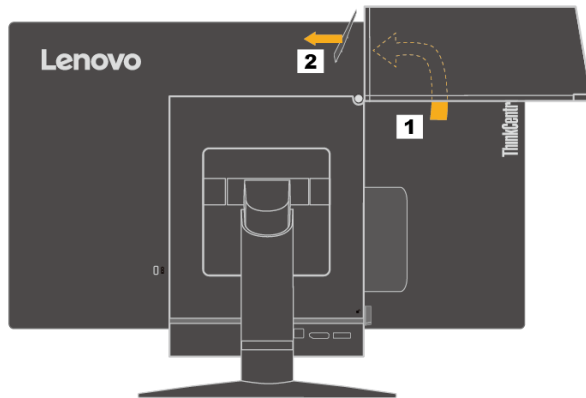

2. Screw the rear Wi-Fi antenna to the antenna connector on the rear of the computer. Then, adjust the angle of the antenna to 90 degrees.

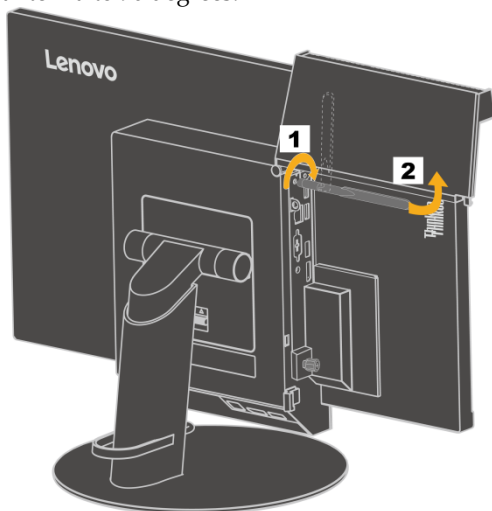

3. Pivot the cable cover as shown to the closed position.

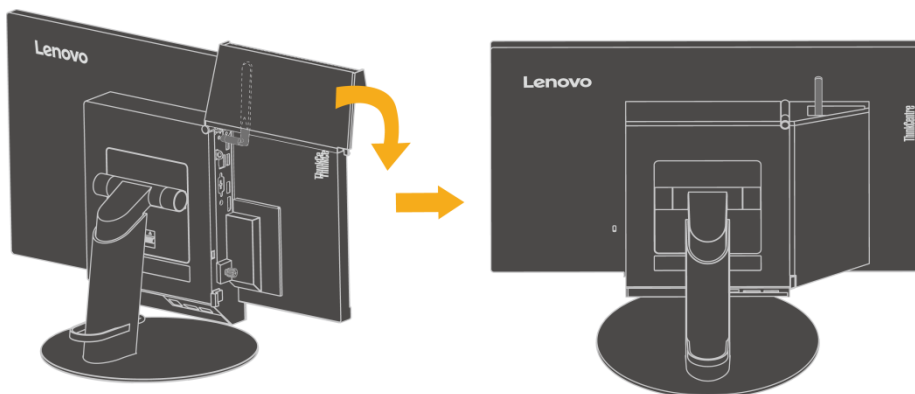

Part 4: Install the Kensington-style cable lock (optional).

With the key of the Kensington-style cable lock, attach the lock to the security-lock slot on the rear panel of your computer as shown. The lock secures your monitor to a desk, table, or other non-permanent fixture. It also locks the 3-in-1 cable so that the Tiny cannot be removed from the monitor.

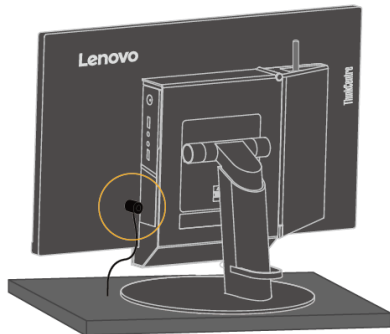

Connecting cables

After assembling your monitor, you must connect cables correctly to use the monitor and computer. Your monitor can be used with either the Tiny installed in the monitor or an external desktop computer. To connect cables, do one of the following:

- If you use the Tiny installed in the monitor, connect the ac power adapter cable and power cord that comes with the monitor. First connect the ac power adapter cable to the ac power adapter connector on the monitor. Then, connect one end of the power cord to the ac power adapter and the other end to a properly-grounded electrical outlet.

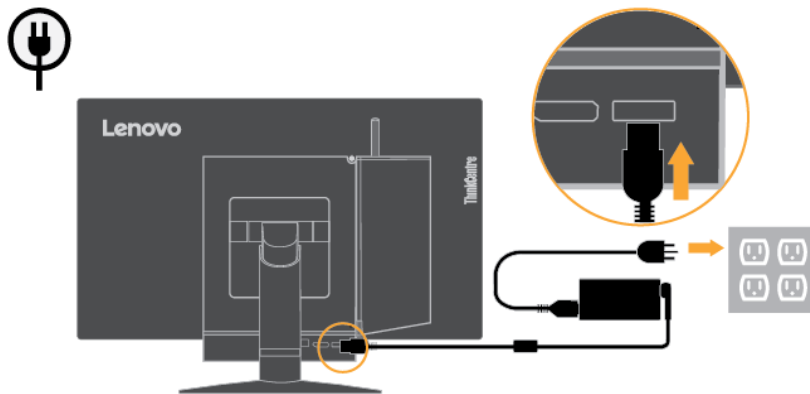

- If you use the external desktop computer, do the following:
 1. Use a DisplayPort cable of this type as shown. Connect one end of the DisplayPort cable to the DisplayPort connector on the monitor and the other end to a DisplayPort connector on the computer. To locate the DisplayPort connector on the monitor, see “Locating connectors and controls on your monitor” on page 2.

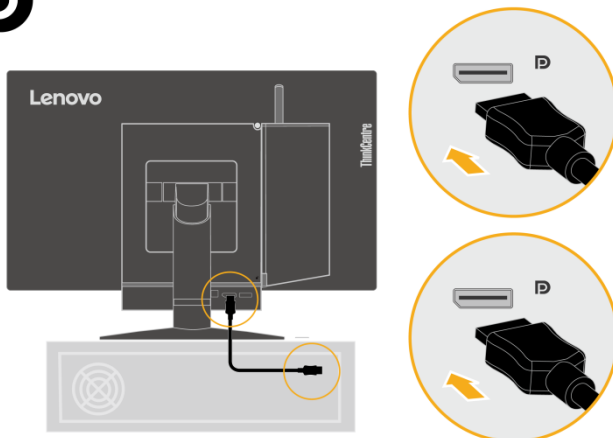

2. Use a type B-to-type A USB cable as shown. Connect type B connector of this cable to the USB 3.0 upstream connector on the monitor. Then, connect type A connector of the cable to a USB connector on the computer. To locate the USB 3.0 upstream connector on the monitor, see “Locating connectors and controls on your monitor” on page 2.

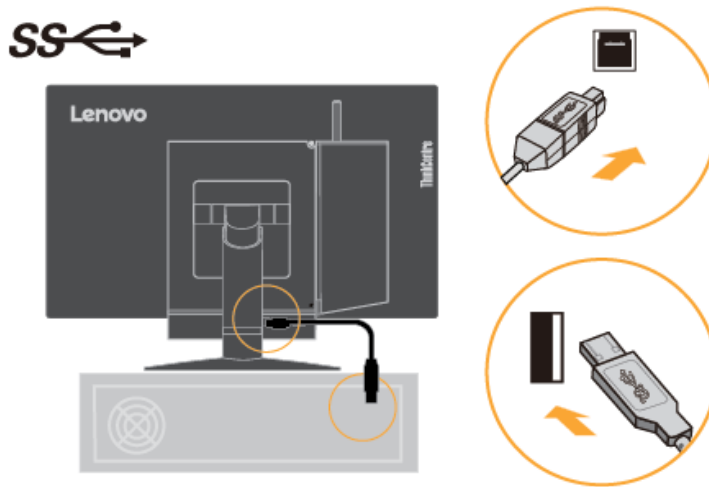

3. Connect the ac power adapter cable of the monitor to the ac power adapter connector on the monitor first. Then, connect one end of the monitor power cord to the ac power adapter and the other end to a properly-grounded electrical outlet.

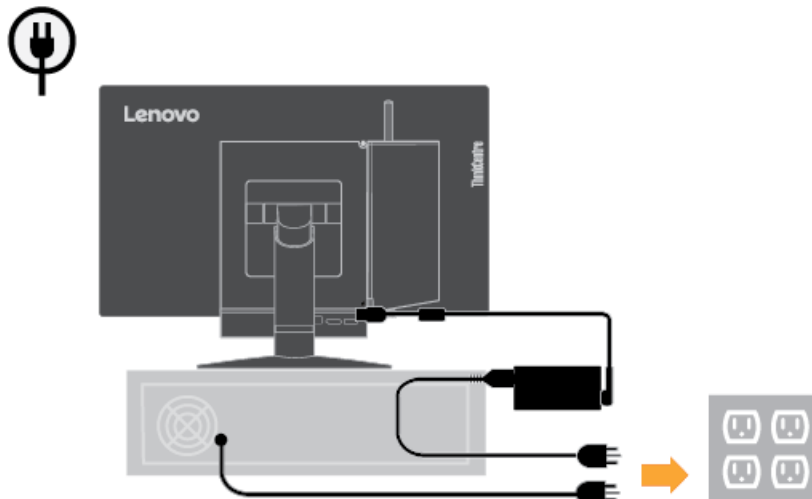

Turning on your monitor and computer

To turn on your monitor and computer, do one of the following:

- If you only have the Tiny installed in the monitor, press the power button on the monitor to turn on your monitor and computer. To locate the power button, see “Locating connectors and controls on your monitor” on page 2.
- If you only have the external desktop computer connected to the monitor, press the power button on the monitor to turn on your monitor. Then, press the power button on the computer to turn on your computer. To locate the power button, see “Locating connectors and controls on your monitor” on page 2.
- If you have both the Tiny installed in the monitor and the external desktop computer connected to the monitor, do one of the following:
 - If you use the Tiny, press the power button on the monitor to turn on your monitor and computer. To locate the power button, see “Locating connectors and controls on your monitor” on page 2.
 - If you use the external desktop computer, press the mode-switching button on the monitor to select the DP mode so that the monitor is turned on. Then, press the power button on the computer to turn on your computer. To locate the mode-switching button, see “Locating connectors and controls on your monitor” on page 2.

Note: When both the Tiny and the external desktop computer are working, you can press the mode-switching button to switch between the two computers. When you select the AIO mode, you will use the Tiny. When you select the DP mode, you will use the external desktop computer.

When you switch between the AIO mode and the DP mode, ensure that no data is being transmitted between your computer and any USB device that is connected to your monitor. If you switch between the two modes while the USB data is being transmitted, the transmission will be interrupted and loss of data may result. When you switch between the AIO mode and the DP mode the following is required to wake your computer from sleep or hibernation:

- DP mode to AIO mode. If the Tiny installed in your monitor is in sleep or hibernation mode, press the power button of the monitor to wake up the Tiny.
- AIO mode to the DP mode. If the external desktop computer is in sleep or hibernation mode, press the power button of the external desktop computer to wake up it.

Note: When you switch between AIO mode and DP mode, the keyboard and mouse that are connected to your monitor are also switched and cannot waken your computer.

Chapter 2 Adjusting and using your monitor

This section will give you information on adjusting and using your monitor.

Adjusting the full-function monitor stand

You can use the full-function monitor stand to adjust the monitor to your comfortable position.

1. The following illustration shows that you can adjust the monitor at an angle of -5° to the front and 35° to the rear.

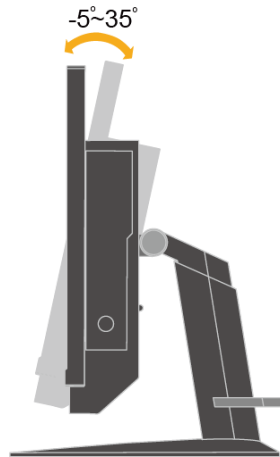

2. The following illustration shows that you can turn the monitor at an angle of 45° to the left and 45° to the right.

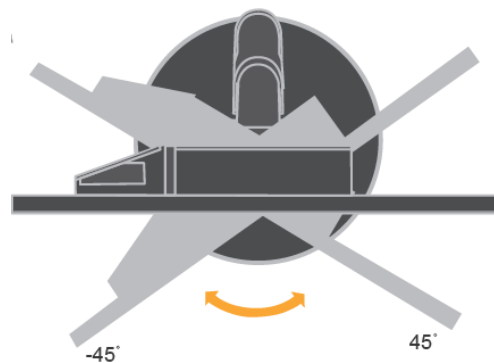

3. The following illustration shows that you can adjust the height of the full-function monitor stand within a length of 110 mm.

Note: Before you adjust the height, ensure that you pull out the latch that secures the stand and read the instructions on the label of the latch.

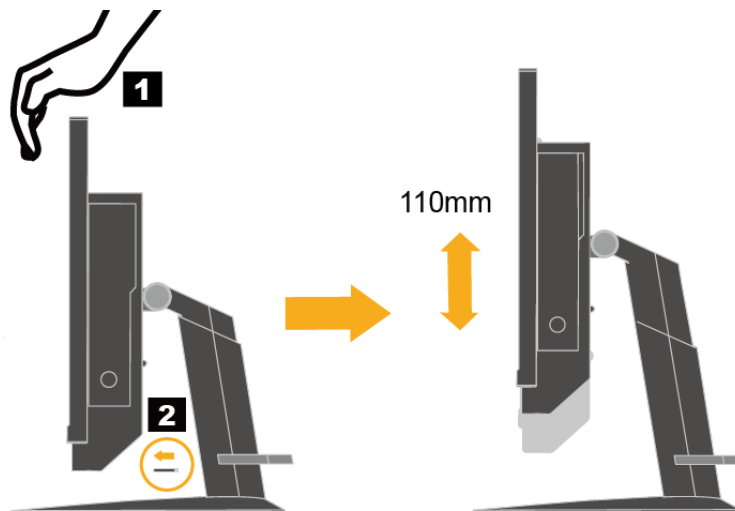

Installing the monitor driver

To enjoy a better monitor performance, it is recommended that you install the monitor driver before using the monitor.

To install the monitor driver, do one of the following:

- If the optical drive is available, insert the CD that comes with the monitor into the optical drive. Then, follow the instructions on the screen.
- If the optical drive is not available, download the driver from the Lenovo Web site at <http://support.lenovo.com/docs/TIO22D>. Then, follow the instructions in "Manually installing the monitor driver" on page 24.

Comfort and accessibility

Good ergonomic practice is important to get the most from your personal computer and to avoid discomfort. Arrange your workplace and the equipment you use to suit your individual needs and the kind of work that you perform. In addition, use healthy work habits to maximize your performance and comfort while using your computer.

Arranging your work area

Use a work surface of appropriate height and available working area to allow you to work in comfort.

Organize your work area to match the way you use materials and equipment. Keep your work area clean and clear for the materials that you typically use and place the items that you use most frequently, such as the computer mouse or telephone, within the easiest reach.

Equipment layout and setup play a large role in your working posture. The following topics describe how to optimize equipment setup to achieve and maintain good working posture.

- **Positioning and viewing your monitor:**

Position and adjust your computer monitor for comfortable viewing by considering the following items:

- **Viewing distance:**

Optimal viewing distances for monitors range from approximately 510mm to 760mm (20 in to 30 in) and can vary depending on ambient light and time of day. You can achieve different viewing distances by repositioning your monitor or by modifying your posture or chair position. Use a viewing distance that is most comfortable for you.

- **Monitor height:**

Position the monitor so your head and neck are in a comfortable and neutral (vertical, or upright) position. If your monitor does not have height adjustments, you might have to place books or other sturdy objects under the base of the monitor to achieve the desired height. A general guideline is to position the monitor such that the top of the screen is at or slightly below your eye-height when you are comfortably seated. However, be sure to optimize your monitor height so the line of site between your eyes and the centre the monitor suits your preferences for visual distance and comfortable viewing when your eye muscles are in a relaxed state.

- **Tilt :**

Adjust the tilt of your monitor to optimize the appearance of the screen content and to accommodate your preferred head and neck posture.

- **General location:**

Position your monitor to avoid glare or reflections on the screen from overhead lighting or nearby windows.

The following are some other tips for comfortable viewing of your monitor:

- Use adequate lighting for the type of work you are performing.
- Use the monitor brightness, contrast, and image adjustment controls, if equipped, to optimize the image on your screen to meet your visual preferences.
- Keep your monitor screen clean so you can focus on the screen's contents.

Any concentrated and sustained visual activity can be tiring for your eyes. Be sure to periodically look away from your monitor screen and focus on a far object to allow your eye muscles to relax. If you have questions on eye fatigue or visual discomfort, consult a vision care specialist for advice.

Quick tips for healthy work habits

The following information is a summary of some important factors to consider to help you remain comfortable and productive while you use your computer.

- **Good posture starts with equipment setup:**

The layout of your work area and the setup of your computer equipment have a large effect on your posture while using your computer. Be sure to optimize the position and orientation of your equipment by following the tips outlined in “Arranging your work area ” on page **10** so you can maintain a comfortable and productive posture. Also, be sure to use the adjustment capabilities of your computer components and office furniture to best suit your preferences now and as your preferences change over time.

- **Minor changes in posture can help avoid discomfort:**

The longer you sit and work in front of your computer, the more important it is to observe your working posture. Avoid assuming any one posture for an extended period of time. Periodically make minor modifications in your posture to help deter any discomforts that might arise. Make use of any adjustments that your office furniture or equipment provide to accommodate changes in posture

- **Short, periodic breaks help ensure healthy computing:**

Because computing is primarily a static activity, it is particularly important to take short breaks from your work. Periodically, stand up in front of your work area, stretch, walk for a drink of water, or otherwise take a short break from using your computer. A short break from work gives your body a welcome change in posture and helps to ensure you remain comfortable and productive while you do work.

Accessibility information

Lenovo is committed to providing greater access to information and technology to people with disabilities. With assistive technologies, users can access information in the way most appropriate to their disability. Some of these technologies are already provided in your operating system; others can be purchased through vendors or accessed at:

https://lenovo.ssbartgroup.com/lenovo/request_vpat.php

Adjusting your monitor image

This section describes the user control features used to adjust your monitor image.

Using the user controls

Your monitor has four user controls on the front panel. To locate the user controls, see “Locating connectors and controls on your monitor” on page 2. You can use the user controls to adjust some settings of your monitor on the On Screen Display (OSD) main menu.

- Mode-switching button / back button
Used to switch between the AIO mode (using the Tiny installed) and the DP mode (using an external desktop computer). You also can press the button to move back and exit from the OSD menu.
- Left shift button
Used to move to the left on the OSD menu.
- Right shift button / brightness control
Used to move to the right on the OSD menu and adjust the brightness.
- Selection button / menu-opening button
Used to open the OSD main menu and select an option.

Using the OSD controls

The settings adjustable with the user controls are viewed through the OSD, as shown below.

Note: When switching to AIO mode, the monitor and the Tiny share the same power button on the monitor. However, if the enhanced power saving mode is enabled in the BIOS of the Tiny, you can only use the power button of the computer to turn on the computer.

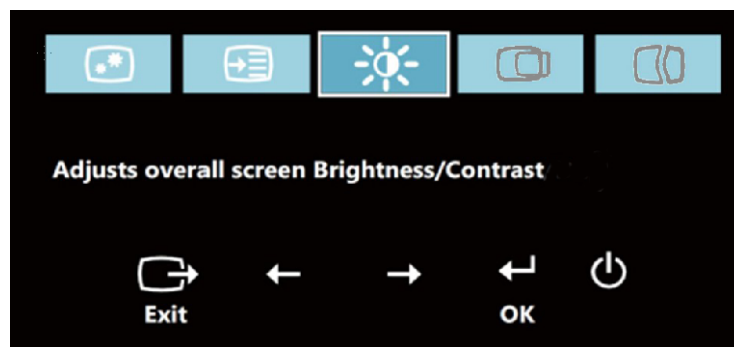

To use the controls:

1. Press to open the main OSD menu.
2. Use or to move among the icons. Select an icon and press to access that function. If there is a sub-menu, you can move between options using or , then press to select that function. Use or to make adjustments. Press to save.
3. Press to move backwards through the sub-menus and exit from the OSD.
4. Press and hold for 10 seconds to lock the OSD. This will prevent accidental adjustments to the OSD. Press and hold for 10 seconds to unlock the OSD and allow adjustments to the OSD.
5. Enables DDC/CI by default. Use OSD Left Arrow Key, press and hold the buttons for 5 seconds to disable/enable DDC/CI function. The words " DDC/CI Disable/DDC/CI/Enable" shows on the screen.

Using the USB connectors

Your monitor has three USB connectors. To locate the USB connectors, see “Locating connectors and controls on your monitor” on page 2.

- USB 3.0 connectors

Used to attach a device that requires a USB 2.0 or USB 3.0 connection, such as a keyboard, a mouse, a scanner, or a printer.

Note: The two USB 3.0 connectors on the front panel can only be used as USB 2.0 connectors in one of the following conditions:

- You use the Tiny installed in the monitor and the 3-in-1 cable is connected to a USB 2.0 connector on the computer.
- You use an external desktop computer and the USB cable is connected to a USB 2.0 connector on the computer.

- USB 3.0 upstream connector

Used to transfer signals from the external desktop computer to the monitor.

Using the audio

Your monitor has only one headset connector that also is known as audio jack. To locate the headset connector, see “Locating connectors and controls on your monitor” on page 2. You can connect a headset to the headset connector. After adjusting the audio setting, you can use the headset to listen to and record audio. To adjust the audio setting, do the following:

1. Right-click the volume icon on the taskbar at the bottom-right corner of the desktop. Then, select **Volume control options**. The Volume Control Options opens.
2. In the **Sound devices** area, select **TinyinOne22**.
3. Click **Apply** to save the setting.

Table 2-1. OSD functions





















OSD Icon on Main Menu	Submenu	Description	Controls and Adjustments (DP)
 Brightness/Contrast	Brightness	Adjusts overall brightness	— +
 Brightness/Contrast	Contrast	Adjusts difference between light and dark areas	— +
 Image Properties	Input Signal ● AIO Mode	Switch between the AIO mode (using the Tiny installed) and the DP mode (using an external desktop computer). Use the source from the Tiny.	
 Image Properties	Input Signal ● DP	Use the source from DP connector of external desktop computer.	
 Image Properties	Color	Adjusts intensity of red, green, and blue. Preset mode ● Neutral ● sRGB ● Reddish ● Bluish Custom : ● Red: Increases or decreases the saturation of 'red' in the image. ● Green: Increases or decreases the saturation of 'green' in the image. ● Blue: Increases or decreases the saturation of 'blue' in the image.	
 Image Properties	Scaling	● Original AR Same Aspect Ratio with input signal ● Full Expand image to full screen	
 Image Properties	Over Drive	On Off	

Table 2-2. OSD functions

OSD Icon on Main Menu	Submenu	Description
 Options	 Information	Shows resolution, refresh rate, and product details. Note: This screen does not allow any changes to the settings. This section lists the languages supported by your monitor.
 Options	 Language	Note: The language chosen only affects the language of the OSD. It has no effect on any software running on the computer.
 Options	 Menu Position Default Custom	Menu position adjusts menu location on the screen. Returns the menu position to the default settings. <ul style="list-style-type: none"> • Horizontal: Changes the horizontal position of the OSD • Vertical: Changes the vertical position of the OSD. • Save
 Options	 Factory Default	Resets monitor to the original factory settings. <ul style="list-style-type: none"> • Cancel • Reset
 Options	 Accessibility	Controls button and menu settings for accessibility preferences. <ul style="list-style-type: none">  Button repeat rate: Select ← or → to change. <ul style="list-style-type: none"> • Off • Default • Slow  Menu time out: Sets the length of time the OSD will remain active after the last time a button is pressed.
 Exit		Exit the main menu

Selecting a supported display mode

The display mode that monitor uses is controlled by the computer. Therefore, refer to your computer documentation for details on how to change display modes.

The image size, position and shape might change when the display mode changes. This is normal and the image can be readjusted using automatic image setup and the image controls.

Unlike CRT monitors, which require a high refresh rate to minimize flicker, LCD or Flat Panel technology is inherently flicker-free.

Note: If your system has previously been used with a CRT monitor and is currently configured to a display mode outside the range of this monitor, you may need to re-attach the CRT monitor temporarily until you have re-configured the system; preferably to 1920x1080 at 60Hz, which is the Native Resolution Display mode.

The display modes shown below have been optimized at the factory.

Table 2-3. Factory set display modes

Addressability	Refresh rate
640x350	70Hz
640x480	60Hz, 66Hz,72Hz,75Hz
720x400	70Hz
800x600	60Hz,72Hz,75Hz
1024x768	60Hz,70Hz,75Hz
1152x864	75Hz
1280x768	60Hz
1280x800	60Hz
1280x1024	60Hz,72Hz,75Hz
1366x768	60Hz
1440x900	60Hz, 75Hz
1600x1200	60Hz, 70Hz,75Hz
1680x1050	60Hz
1920x1080	R60Hz

Understanding power management

Power management is invoked when the computer recognizes that you have not using your mouse or keyboard for a user-definable period. There are several states as described in the table below.

For optimal performance, switch off your monitor at the end of each working day, or whenever you expect to leave it unused for long periods during the day.

Table2-4. Power indicator

State	Power Indicator	Screen	Restoring Operation	Compliance
On	Steady green (AIO Mode/DP)	Normal		
Standby/ Suspend	Blinking green (AIO Mode) Steady amber (DP)	Blank	Press a key or move the mouse. There may be a slight delay reappears. Note: Standby also occurs if there is no image output to the monitor.	ENERGY STAR
Off	Off (AIO Mode/DP)	Off	Press power key to switch on There may be a slight delay before the image reappears.	ENERGY STAR

Caring for your monitor

Be sure to turn off the power before you perform any maintenance on the monitor.

Do not:

- Apply water or liquid directly to your monitor.
- Use solvents or abrasives.
- Use flammable cleaning materials to clean your monitor or any other electrical equipment.
- Touch the screen area of your monitor with sharp or abrasive items. This type of contact may cause permanent damage to your screen.
- Use any cleaner which contains an anti-static solution or similar additives. This may harm the coating of the screen area.

Do:

- Lightly dampen a soft cloth with water and use this to gently wipe the covers and the screen.
- Remove grease or finger marks with a damp cloth and a little mild detergent.

Chapter 3 Reference information

This section contains Disassembling your monitor, monitor specifications, instructions to manually install the monitor driver, troubleshooting information, and service information.

Disassembling your monitor

To disassemble your monitor, follow the four parts below one by one:

Part 1: Remove the Kensington-style cable lock (optional).

Part 2: Remove the rear Wi-Fi antenna (optional).

Part 3: Remove the Tiny.

Part 4: Remove the full-function monitor stand.

Part 1: Remove the Kensington-style cable lock (optional).

With the key of the Kensington-style cable lock, unlock the lock that is attached to the rear panel of your computer.

Part 2: Remove the rear Wi-Fi antenna (optional).

1. Press the cable cover 1 to open it. Then, pivot the cable cover as shown to the open position.

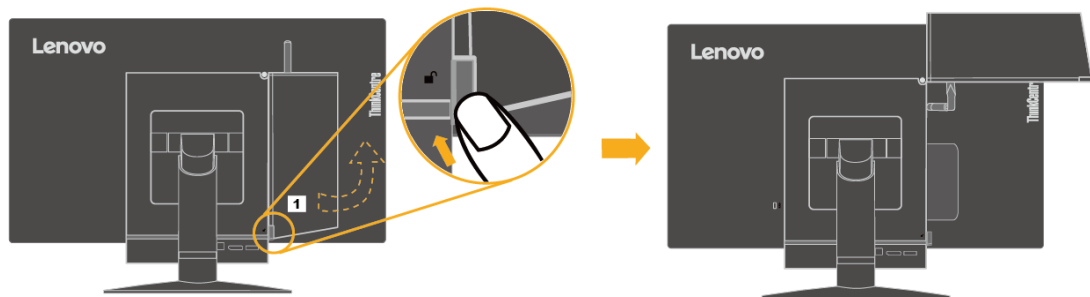

2. Pivot the rear Wi-Fi antenna downward at an angle of about 90°. Then, hold the thicker end of the rear Wi-Fi antenna and unscrew it from the computer.

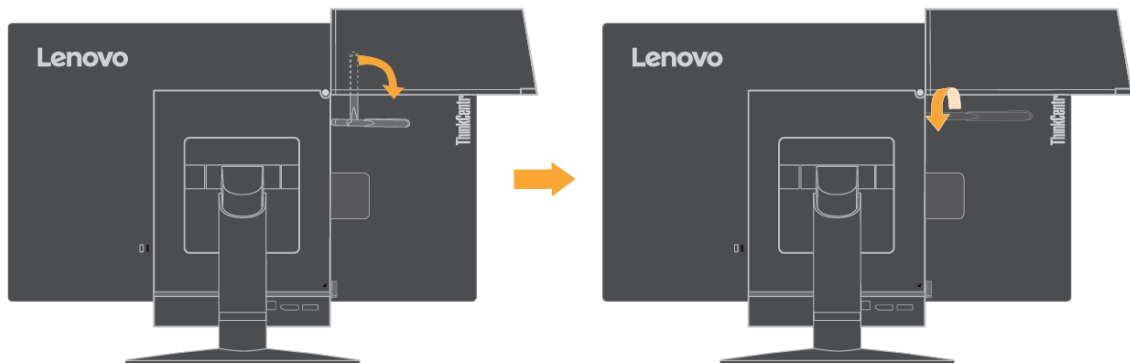

Part 3: Remove the Tiny.

1. Release the screw that secures the computer.

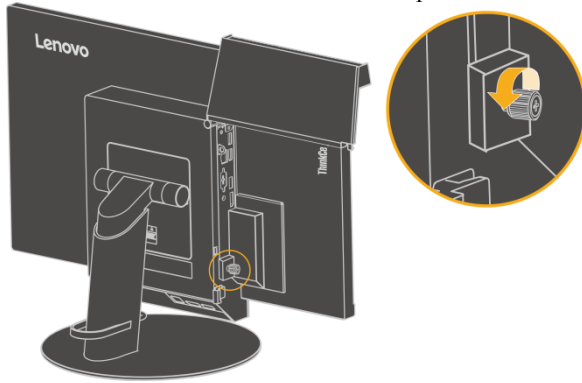

2. Push the computer from the rear as shown to disconnect it completely from the 3 in 1 cable.

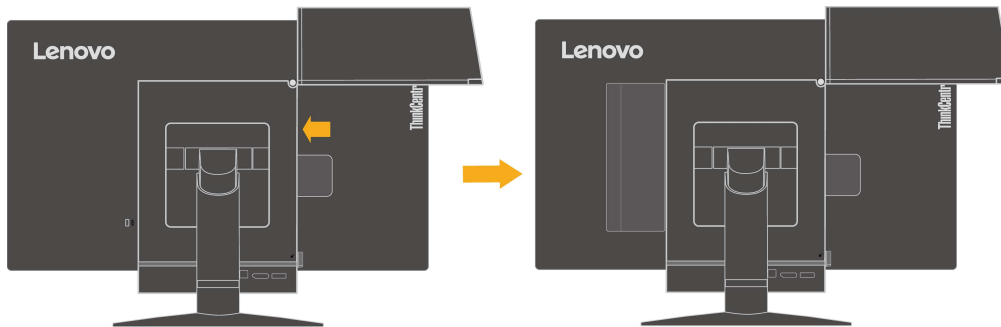

3. Pull the computer out of the computer bay. Then, pivot the cable cover as shown to the closed position.

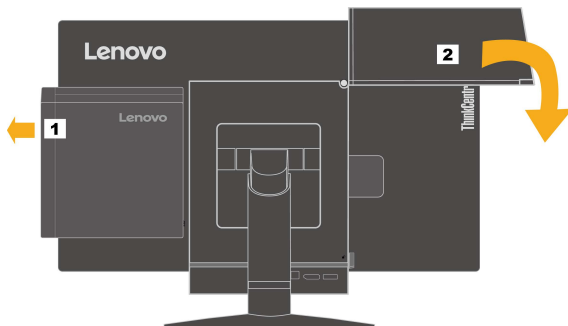

4. If the two decorative covers of the computer bay are available, insert the two covers into the corresponding slots.

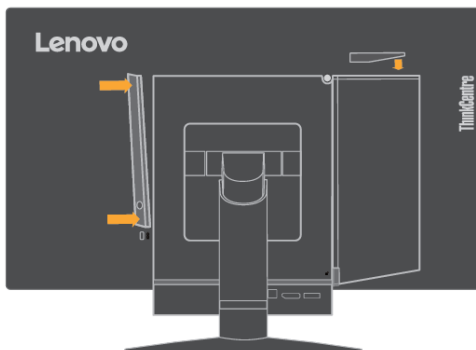

Part 4: Remove the full-function monitor stand.

1. Place a soft, clean towel or cloth on the desk or surface. Hold the sides of your monitor and gently lay it down so that the screen is against the surface and the cover is facing up.
2. Slide the latch upward as shown. Then, pivot the monitor stand upward to remove it.

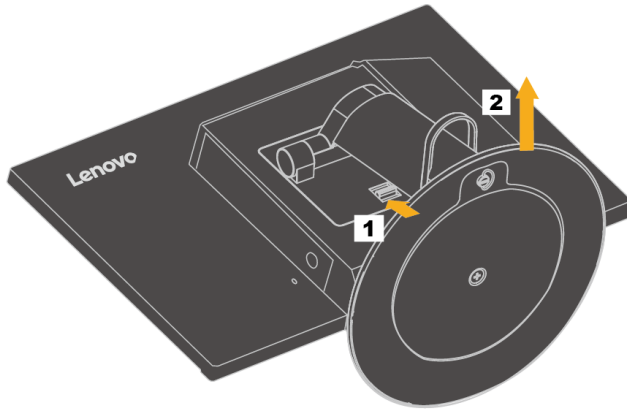

3. If you want to hang your monitor on the wall, you can install a VESA mount bracket that can be ordered from Lenovo.

Monitor specifications

Table 3-1. Monitor specifications for type-model 10LK-PAR6-WW

Dimensions	Height Depth Width	356 mm (14.02 in.) 251 mm (9.88 in.) 489 mm (19.25 in.)
Stand	Tilt range	Range: -5°/+35°
Stand	Swivel	Range: -45°, +45°
Stand	Lift	Range: 110.0 mm
VESA mount	Supported	100 mm (3.94 in.)
Image	Viewable image size Maximum height Maximum width Pixel pitch	546 mm (21.5 in.) 284 mm (11.20 in.) 485 mm (19.08 in.) 0.248mm (H)x0.248 mm (V)
Power input Power consumption Note: Power consumption figures are for the monitor and the power supply combined.	Supply voltage Max supply current Max Consumption Typical Consumption Standby/Suspend Off	20VDC 4.5 A 35 W 47.7 KWh ≅1.2 W ≅0.5 W
Video input (Digital)	Interface Horizontal addressability Vertical addressability Clock frequency	DP 1920 pixels (max) 1080 lines (max) 10.8 Gbps(max)
Communications	VESA DDC	CI
Altitude Test	Operation	16404.2 ft
Supported Display Modes (VESA Standard modes between noted ranges)	Horizontal frequency Vertical frequency Native Resolution	DP: 30 kHz - 83 kHz 30 Hz - 75 Hz 1920 x 1080 at 60 Hz
Temperature	Operating Storage Shipping	0° to 40°C (32°F to 104° F) -20° to 60°C (-4°F to 140° F) -20° to 60°C (-4° F to 140° F)
Humidity	Operating Storage Shipping	8% to 80% 10% to 90% 10% to 90%

Troubleshooting

If you have a problem setting up or using your monitor, you might be able to solve it yourself. Before calling your dealer or Lenovo, try the suggested actions that are appropriate to your problem.

Table3-2. Troubleshooting

Problem	Possible cause	Suggested action	Reference
The words " Out of Range" are shown on the screen, and the power indicator is flashing green.	The system is set to a display mode which is not supported by the monitor.	<ul style="list-style-type: none"> • If you are replacing an old monitor, reconnect it and adjust the display mode to within the specified range for your new monitor. • If using a Windows® system, restart the system in safe mode, then select a supported display mode for your computer. • If these options do not work, contact the Customer Support Centre. 	"Selecting a supported display mode" on page 16
The image quality is unacceptable.	The video signal cable is not connected with the monitor or system completely.	Be sure the signal cable is firmly plugged into the system and monitor.	"Setting up your monitor" on page 3
The image quality is unacceptable.	The color settings may be incorrect.	Select another color setting from the OSD menu.	"Adjusting your monitor image" on page 12
The image quality is unacceptable.	The automatic image setup function was not performed.	Perform automatic image setup.	"Adjusting your monitor image" on page 12
The power indicator is not lit and there is no image.	<ul style="list-style-type: none"> • The monitor's power switch is not switched on. • The power cord is loose or disconnected. • There is no power at the outlet. 	<ul style="list-style-type: none"> • Be sure the power cord is connected properly. • Be sure the outlet has power. • Power on the monitor. • Try using another power cord. • Try using another electrical outlet. 	"Setting up your monitor" on page 3

Table3-2. Troubleshooting(continued)

Problem	Possible cause	Suggested action	Reference
Screen is blank and power indicator is steady amber or flashing green	The monitor is in Standby/Suspend mode	<ul style="list-style-type: none"> ● Press any key on the keyboard or move the mouse to restore operation. ● Check the Power options settings on your computer. 	"Understanding power management" on page 16
The power indicator is green, but there is no image.	The video signal cable is loose or disconnected from the system or monitor.	Be sure the video cable is connected with the system properly.	"Setting up your monitor" on page 3
The power indicator is green, but there is no image.	The monitor brightness and contrast are at the lowest setting.	Adjust the brightness and contrast setting on the OSD menu.	"Adjusting your monitor image" on page 12
One or more of the pixels appear discoloured	This is a characteristic of the LCD technology and is not an LCD defect.	If there are more than five pixels missing, contact the Customer Support Centre.	"Service and support" on page 29
<ul style="list-style-type: none"> ● Fuzzy lines in text or a blurry image. ● Horizontal or vertical lines through the image. 	<ul style="list-style-type: none"> ● Image setup has not been optimized ● Your system Display Properties setting have not been optimized. 	Adjust the resolution settings on your system to match the native resolution for this monitor: 1920x1080 at 60 Hz.	"Adjusting your monitor image" on page 12
<ul style="list-style-type: none"> ● Fuzzy lines in text or a blurry image. ● Horizontal or vertical lines through the image. 	<ul style="list-style-type: none"> ● Image setup has not been optimized ● Your system Display Properties setting have not been optimized. 	Perform automatic image setup. If automatic image setup does not help, perform manual image setup.	"Selecting a supported display mode" on page 16
<ul style="list-style-type: none"> ● Fuzzy lines in text or a blurry image. ● Horizontal or vertical lines through the image. 	<ul style="list-style-type: none"> ● Image setup has not been optimized ● Your system Display Properties setting have not been optimized. 	When working in the native resolution, you may find additional improvements by adjusting the Dots Per Inch (DPI) setting on your system.	See the Advanced section of your system's display properties.
The image is not acceptable when switching to dual mode	It has not set the optimum resolution for each mode	<ul style="list-style-type: none"> ● Use ThinkVision® Duo software to optimize the dual screen operation ● Adjust graphic card resolution manually 	"Using the user controls" on page 12

Manual image setup

If automatic image setup does not establish the image that you prefer, perform manual image setup.

Note: Have your monitor powered on for about 15 minutes, until the monitor warms up.

1. Press **↵** at the bottom of the monitor to open the OSD menu.
2. Use **←** or **→** to select **⓪** and press **↵** to access.
3. Use **←** or **→** to select Clock and Phase adjustment.

- **Clock** (pixel frequency) adjusts the number of pixels scanned by one Horizontal sweep. If the frequency is not correct, the screen shows vertical Stripes and the picture does not have the correct width.
- **Phase** adjusts the phase of the pixel clock signal. With a wrong phase adjustment, the picture has horizontal disturbances in light picture.

4. When the image no longer looks distorted, save the Clock and Phase adjustments.
5. Press **⏪** to leave the OSD menu.

Manually installing the monitor driver

Below are steps for manually installing the monitor driver in Microsoft® Windows 7, Microsoft Windows 8, Microsoft Windows 8.1 and Microsoft Windows 10.

Installing the monitor driver in Windows 7

To use the Plug and Play feature in Microsoft Windows 7, do the following:

Note: You must download file from the Reference and Driver CD to use the Plug and Play feature in Windows 7.

1. Turn off the computer and all attached devices.
2. Ensure that the monitor is connected correctly.
3. Turn on the monitor and then turn on the computer. Allow your computer to boot into Windows 7 operating system.
4. Open the **Display Properties** window by clicking **Start, Control Panel** and then click the **Hardware and Sound** icon.
5. Click the **Display** icon.
6. Click the **Adjust Resolution** button.
7. Click the **Advanced Settings** button.
8. Click the **Monitor** tab.
9. Click the **Properties** button.
10. Click the **Driver** tab.
11. Open the "**Update Driver Software-Generic PnP Monitor**" window by clicking on **Update Driver** and then click the "**Browse my computer for driver software**" button.
12. Select "**Let me pick from a list of device drivers on my computer**".
13. Insert the Lenovo Monitor CD into the CD drive and click the **Have Disk** button.
14. Click on the **Browse** button and navigate to the following directory:
X:\Monitor Drivers\ (where X is the drive letter designator for the CD-ROM drive).
15. Select the "**TinyinOne22.inf**" file and click the **Open** button. Click the **OK** button.
16. Select **ThinkCentre Tiny-in-One 22** and click **Next**. The files will be copied from the CD to your hard disk drive.
17. Close all open windows and remove the CD.
18. Restart the computer.

The system will automatically select the maximum refresh rate and corresponding color matching profiles.

Note: On LCD monitors, unlike CRTs, a faster refresh rate does not improve display quality. Lenovo recommends using either 1920 x 1080 at a refresh rate of 60 Hz, or 640 x 480 at a refresh rate of 60 Hz.

Installing the monitor driver in Windows 8

To use the Plug and Play feature in Microsoft Windows 8, do the following:

Note: You must download file from the Reference and Driver CD to use the **Plug and Play** feature in Windows 8.

1. Turn off the computer and all attached devices.
2. Ensure that the monitor is connected correctly.
3. Turn on the monitor and then turn on the computer. Allow your computer to boot into Windows 8 operating system.
4. On the **Desktop**, move mouse to low-right corner of screen, choose **Setting**, double click **Control Panel**, then double click the icon of **Hardware and Sound**, and then clicking **Display**.
5. Click the **Change the display settings** tab.
6. Click the **Advanced Settings** icon.
7. Click the **Monitor** tab.
8. Click the **Properties** button.
9. Click the **Driver** tab.
10. Click **Update Driver**, then click Browse the computer to find the driver program.
11. Select Pick from the list of device driver program on the computer.
12. Click the **Have Disk** button. Click the Browse button and navigate to the following directory:
X:\Monitor Drivers(where X is the drive letter designator for the CD-ROM drive).
13. Select the " **TinyinOne22.inf** "file and click the **Open** button. Click the **OK** button.
14. Select **ThinkCentre Tiny-in-One 22** and click **Next**. The files will be copied from the CD to your hard disk drive.
15. Close all open windows and remove the CD.
16. Restart the system. The system will automatically select the maximum refresh rate and corresponding Color Matching Profiles.

The system will automatically select the maximum refresh rate and corresponding color matching profiles.

Note: On LCD monitors, unlike CRTs, a faster refresh rate does not improve display quality. Lenovo recommends using either 1920 x 1080 at a refresh rate of 60 Hz, or 640 x 480 at a refresh rate of 60 Hz.

Installing the monitor driver in Windows 8.1

To install the device driver in Microsoft Windows 8.1, do the following:

Note: You must download files from the Lenovo Monitor CD to use the **Plug and Play** feature in Windows 8.1.

1. Turn off the computer and all attached devices.
2. Ensure that the monitor is connected correctly.
3. Turn on the monitor and then turn on the computer. Allow your computer to boot into Windows 8.1 operating system.
4. On the **Desktop**, move mouse to low-right corner of screen, choose **Setting**, double click **Control Panel**, and then double click the icon of **Hardware and Sound**, and then clicking **Display**.
5. Click the **Change the display settings** tab.
6. Click the **Advanced Settings** icon.
7. Click the **Monitor** tab.
8. Click the **Properties** button.
9. Click the **Driver** tab.
10. Click **Update Driver**, then click **Browse the computer to find the driver program**.
11. Select **Pick from the list of device driver program on the computer**.
12. Click the **Have Disk** button. Click the **Browse** button and navigate to the following directory:
X:\Monitor Drivers (where X is the drive letter designator for the CD-ROM drive).
13. Select the "**TinyinOne22.inf**" file and click the **Open** button. Click the **OK** button.
14. Select **ThinkCentre Tiny-in-One 22** and click **Next**. The files will be copied from the CD to your hard disk drive.
15. Close all open windows and remove the CD.
16. Restart the system. The system will automatically select the maximum refresh rate and corresponding Color Matching Profiles.

The system will automatically select the maximum refresh rate and corresponding color matching profiles.

Note: On LCD monitors, unlike CRTs, a faster refresh rate does not improve display quality. Lenovo recommends using either 1920 x 1080 at a refresh rate of 60 Hz, or 640 x 480 at refresh rate of 60 Hz.

Installing the monitor driver in Windows 10

To install the device driver in Microsoft Windows 10, do the following:

Note: You must download files from the Lenovo Monitor CD to use the Plug and Play feature in Windows 10.

1. Turn off the computer and all attached devices.
2. Ensure that the monitor is connected correctly.
3. Turn on the monitor and then turn on the computer. Allow your computer to boot into Windows 10 operating system.
4. On the Desktop, move the mouse cursor to the small Window Icon on the lower left corner of screen and right click, then choose Control Panel, then double click the Hardware and Sound icon and then click the Display.
5. Click the **Change the display settings** tab.
6. Click the **Advanced Settings** icon.
7. Click the **Monitor** tab.
8. Click the **Properties** button.
9. Click the **Driver** tab.
10. Click **Update Driver**, then click Browse the computer to find the driver program.
11. Select Pick from the list of device driver program on the computer.
12. Click the **Have Disk** button. Click the **Browse** button and navigate to the following directory:
X:\Monitor Drivers (where X is the drive letter designator for the CD-ROM drive).
13. Select the "**TinyinOne22.inf**" file and click the Open button. Click the OK button.
14. Select **ThinkCentre Tiny-in-One 22** and click **Next**. The files will be copied from the CD to your hard disk drive.
15. Close all open windows and remove the CD.
16. Restart the system. The system will automatically select the maximum refresh rate and corresponding Color Matching Profiles.

Service information

Product numbers

The product number for your monitor is located on the side of the display bezel as shown below.

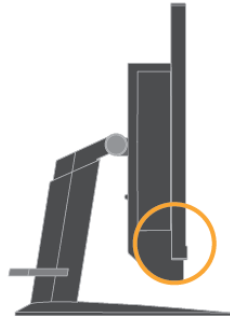

Customer responsibilities

The warranty does not apply to a product which has been damaged due to accident, misuse, abuse, improper installation, usage not in accordance with product specifications and instructions, natural or personal disaster, or unauthorized alterations, repairs or modifications.

The following are examples of misuse or abuse and not covered by warranty:

- Images burned on to the screen of a CRT monitor. Burned image is preventable by utilizing a moving screen saver or power management.
- Physical damage to covers, bezel, base and cables.
- Scratches or punctures on monitor screens.
- Pivot the monitor when working in AIO mode.

Getting further help

If you still can't solve your problem, please contact the Customer Support Centre. For more information on contacting the Customer Support Centre, please see "Service and support," on page 29.

Service parts

The following parts are for use by Lenovo service, or Lenovo authorized dealers to support the customer warranty. Parts are for service use only. The table below shows information for model 10LK-PAR6-WW.

Table 3-3. List of service parts

FRU (Field Replaceable Unit) Part number	Description	color	Machine Type Model (MTM)
00PC071	Tiny-in-One 22 Monitor (22inch Monitor, DP& 3in1 port)	Raven Black	10LK-PAR6-WW
54Y8966	90w Power Brick (DT&AIO Common 90W with CMN)		
00PC072	Tiny-in-One 22 Monitor - FRU Stand and Base	Raven Black	10LK-PAR6-WW

Appendix A Service and support

The following information describes the technical support that is available for your product, during the warranty period or throughout the life of the product. Refer to your Lenovo Statement of Limited Warranty for a fully explanation of Lenovo warranty terms.

Registering your option

Register to receive product service and support updates, as well as free and discounted computer Accessories and content. Go to:
<http://www.lenovo.com/support>

Online technical support

Online technical support is available during the life of your product through the Lenovo Support Web site at <http://www.lenovo.com/support>

Product replacement assistance or exchange of defective components also is available during the warranty period, assistance for replacement or exchange of defective components is available. In addition, if your option is installed in a Lenovo computer, you might be entitled to service at your location. Your technical support representative can help you determine the best alternative.

Telephone technical support

Installation and configuration support through the Customer Support Centre will be withdrawn or made available for a fee, at Lenovo's discretion, 90 days after the option has been withdrawn from marketing. Additional support offerings, including step-by-step installation assistance, are available for a nominal fee.

To assist the technical support representative, have available as much of the following information as possible:

- Option name
- Option number
- Proof of purchase
- Computer manufacturer, model, serial number, and manual
- Exact wording of the error message (if any)
- Description of the problem
- Hardware and software configuration information for your system

If possible, be at your computer. Your technical support representative might want to walk you through the problem during the call.

Worldwide telephone list

Phone numbers are subject to change without notice. For the most current phone Numbers, go to <http://www.lenovo.com/support/phone>

Country or Region	Telephone Number
Africa	Africa: +44 (0) 1475-555-055 South Africa: +27-11-3028888 and 0800110756 Central Africa: Contact the nearest Lenovo Business Partner
Argentina	0800-666-0011 (Spanish)
Australia	131-426 (English)
Austria	Warranty service and support: 01-211-454-610 (German)
Belgium	Warranty service and support: 02-225-3611 (Dutch, French)
Bolivia	0800-10-0189 (Spanish)
Brazil	Sao Paulo region: (11) 3889-8986 Outside Sao Paulo region: 0800-701-4815 (Brazilian Portuguese)
Brunei	801-1041 (English , Bahasa Melayu)
Canada	Toronto:416-383-3344 Outside Toronto: 1-800-565-3344 (English , French)
Chile	Toll Free: 188-800-442-488 800-361-213 (Spanish)
China	86-10-58851110 800-990-8888 (Mandarin)
China (Hong Kong S.A.R.)	(852)3071-3561 (Cantonese, English, Mandarin)
China (Macau S.A.R.)	ThinkCentre Commercial PC: 795-9892 Multimedia Home PC: 0800-336 (Cantonese, English, Mandarin)
Colombia	1-800-912-3021 (Spanish)
Costa Rica	0-800-011-1029(Spanish)
Croatia	0800-0426
Cyprus	+357-22-841100
Czech Republic	+420-2-7213-1316
Denmark	Warranty service and support: 7010-5150 (Danish)
Dominican Republic	1-866-434-2080(Spanish)
Ecuador	1-800-426911(Spanish)
Egypt	+202-35362525
El Salvador	800-6264 (Spanish)
Estonia	+372 6776793 +372 66 00 800
Finland	Warranty service and support: +358-800-1-4260(Finnish)
France	Warranty service and support (hardware): 0810-631-213 Warranty service and support (software): 0810-631-020 (French)
Germany	Warranty service and support: 01805-00-46-18 (German)
Greece	+30-210-680-1700
Guatemala	1800-624-0051 (Spanish)
Honduras	Tegucigalpa: 232-4222 San Pedro Sula: 552-2234 (Spanish)
Hungary	+36-1-382-5716 +36-1-382-5720 (English, Hungarian)
India	1800-425-2666 +91-80-2535-9182 (English)
Indonesia	021 5238 823 Local number only: 001-803-606-282 DID (Direct Inward Dialing): +603 8315 6859 (English, Bahasa Indonesia)

Country or Region	Telephone Number
Ireland	Warranty service and support: 01-881-1444 (English)
Israel	Givat Shmuel Service and Center: +972-3-531-3900 (Hebrew, English)
Italy	Warranty service and support: +39-800-820094 (Italian)
Japan	Toll Free: 0120-20-5550 International: +81-46-266-4716 The above numbers will be answered with a Japanese language voice prompt. For telephone support in English, please wait for the Japanese voice prompt to end, and an operator will answer. Please say "English support please", and your call will be transferred to an English-speaking operator. PC software: 0120-558-695 Overseas calls: +81-44-200-8666(Japanese)
Kazakhstan	Call center: +77273231427(Standard charges Apply) (Russian , English)
Kingdom of Saudi Arabia	800 85 000 52 (Standard Charges Apply)
Korea	1588-6782 (Korea)
Latvia	+371 7070360
Lithuania	+370 5 278 66 00
Luxembourg	+352-360-385-343(French)
Malaysia	Local number only: 1800-88-1889 DID: +603 8315 6855 (English, Bahasa Melayu)
Malta	+35621445566
Mexico	001-866-434-2080(Spanish)
Middle East	+44 (0)1475-555-055
Netherlands	+31-20-514-5770 (Dutch)
New Zealand	0800-733-222 (English)
Nicaragua	001-800-220-1830 (Spanish)
Norway	Warranty service and support: 8152-1550(Norwegian)
Panama	Lenovo Customer Support Center: 001-866-434-2080 (Toll Free) 206-6047(Spanish)
Peru	0-800-50-866 (Spanish)
Philippines	1800-1601-0033 (English, Filipino)
Poland	+48-22-878-6999 (Polski)
Portugal	+351-21-892-7046 (Portuguese)
Romania	+4-021-224-4015
Russia	Moscow: +7-(495)-258-6300 Toll Free: +8-800-200-6300 (Russian)
Singapore	Local number only: 800-6011-343 DID: +603 8315 6859 (English)
Slovakia	+421-2-4954-5555
Slovenia	+386-1-200-50-60 (Slovenian)
Spain	91-714-7983,0901-100-000 (Spanish)
Sri Lanka	+9411 2493547 +9411 2493548 (English)
Sweden	Warranty service and support: 077-117-1040 (Swedish)

Country or Region	Telephone Number
Switzerland	Warranty service and support: 0800-55-54-54 (German, French, Italian)
Taiwan	886-2-8723-9799,0800-000-700 (Mandarin)
Thailand	Local number only: 1-800-060-066 66 2273 4088 DID: +603 8315 6857 (Thai, English)
Turkey	02123360366 00800448825165 (Turkish)
Ukraine	044 362 42 81 (Standard Charges Apply)
United Arab Emirates	800035702810 (Standard Charges Apply)
United Kingdom	Standard warranty support: 08705-500-900 (English)
United States	1-800-426-7378 (English)
Uruguay	000-411-005-6649 (Spanish)
Venezuela	0-800-100-2011 (Spanish)
Vietnam	For Northern Area and Hanoi City: 844 3 946 2000 or 844 3 942 6457 For Southern Area and Ho Chi Minh City: 848 3 829 5160 or 844 3 942 6457 (Vietnamese, English)

Appendix B Notices

Lenovo may not offer the products, services, or features discussed in this document in all countries. Consult your local Lenovo representative for information on the products and services currently available in your area. Any reference to a Lenovo product, program, or service is not intended to state or imply that only that Lenovo product, program, or service may be used. Any functionally equivalent product, program, or service that does not infringe any Lenovo intellectual property right may be used instead. However, it is the user's responsibility to evaluate and verify the operation of any other product, program, or service.

Lenovo may have patents or pending patent applications covering subject matter described in this document. The furnishing of this document does not give you any license to these patents. You can send license inquiries, in writing to:

*Lenovo (United States),inc.
1009 Think Place – Building One
Morrisville, NC 27560
U.S.A.
Attention: Lenovo Director of Licensing*

LENOVO PROVIDES THIS PUBLICATION "AS IS" WITHOUT WARRANTY OF ANY KIND, EITHER EXPRESS OR IMPLIED, INCLUDING, BUT NOT LIMITED TO THE IMPLIED WARRANTIES OF NON-INFRINGEMENT,

MERCHANTABILITY OR FITNESS FOR A PARTICULAR PURPOSE.

Some jurisdictions do not allow disclaimer of express or implied warranties in certain transactions, therefore, this statement may not apply to you.

This information could include technical inaccuracies or typographical errors. Changes are periodically made to the information herein; these changes will be incorporated in new editions of the publication. Lenovo may make improvements and/or changes in the product(s) and/or the program(s) described in this publication at any time without notice.

The products described in this document are not intended for use in implantation or other life support applications where malfunction may result in injury or death to persons. The information contained in this document does not affect or change Lenovo product specifications or warranties. Nothing in this document shall operate as an express or implied license or indemnity under the intellectual property rights of Lenovo or third parties. All information contained in this document was obtained from specific environments and presented as an illustration. The result obtained in other operating environments may vary.

Lenovo may use or distribute any of the information you supply in any way it believe appropriate without incurring any obligation to you.

Any references in this publication to non-Lenovo Web sites are provided for convenience only and do not in any manner serve as an endorsement of those Web sites. The materials at those Web sites are not part of the materials for this Lenovo product, and use of those Web sites is at your own risk.

Any performance data contained herein was determined in a controlled environment. Therefore, the result obtained in other operating environments may vary significantly. Some measurements may have been made on development-level systems and there is no guarantee that these measurements will be the same on generally available systems. Furthermore, some measurements may have been estimated through extrapolation. Actual results may vary. Users of this document should verify the applicable data for their specific environment.

Recycling information

Lenovo encourages owners of information technology (IT) equipment to responsibly recycle their equipment when it is no longer needed. Lenovo offers a variety of programs and services to assist equipment owners in recycling their IT products. For information on recycling Lenovo products, go to <http://www.lenovo.com/recycling>. The latest environmental information about our products is available at <http://www.lenovo.com/ecodeclaration>.

環境配慮に関して

本機器またはモニターの回収リサイクルについて

企業のお客様が、本機器が使用済みとなり廃棄される場合は、資源有効利用促進法の規定により、産業廃棄物として、地域を管轄する県知事あるいは、政令市長の許可を持った産業廃棄物処理業者に適正処理を委託する必要があります。また、弊社では資源有効利用促進法に基づき使用済みパソコンの回収および再利用・再資源化を行う「PC回収リサイクル・サービス」を提供しています。詳細は、<http://www.ibm.com/jp/pc/service/recycle/pcrecycle/> をご参照ください。

また、同法により、家庭で使用済みとなったパソコンのメーカー等による回収再資源化が 2003 年 10 月 1 日よりスタートしました。詳細は、<http://www.ibm.com/jp/pc/service/recycle/pcrecycle/> をご参照ください。

重金属を含む内部部品の廃棄処理について

本機器のプリント基板等には微量の重金属（鉛など）が使用されています。使用後は適切な処理を行うため、上記「本機器またはモニターの回収リサイクルについて」に従って廃棄してください。

Collecting and recycling a disused Lenovo computer or monitor

If you are a company employee and need to dispose of a Lenovo computer or monitor that is the property of the company, you must do so in accordance with the Law for Promotion of Effective Utilization of Resources. Computers and monitors are categorized as industrial waste and should be properly disposed of by an industrial waste disposal contractor certified by a local government. In accordance with the Law for Promotion of Effective Utilization of Resources, Lenovo Japan provides, through its PC Collecting and Recycling Services, for the collecting, reuse, and recycling of disused computers and monitors. For details, visit the Lenovo Web site at

www.ibm.com/jp/pc/service/recycle/pcrecycle/. Pursuant to the Law for Promotion of Effective Utilization of Resources, the collecting and recycling of home-used computers and monitors by the manufacturer was begun in October 1, 2003. This service is provided free of charge for home-used computers sold after October 1, 2003. For details, visit the Lenovo Web site at:

www.ibm.com/jp/pc/service/recycle/personal/.

Disposing of Lenovo computer components

Some Lenovo computer products sold in Japan may have components that contain heavy metals or other environmental sensitive substances. To properly dispose of disused components, such as a printed circuit board or drive, use the methods described above for collecting and recycling a disused computer or monitor.

Turkish statement of compliance

The Lenovo product meets the requirements of the Republic of Turkey Directive on the Restriction of the Use of Certain Hazardous Substances in Electrical and Electronic Equipment (EEE).

Türkiye EEE Yönetmeliğine Uygunluk Beyanı

Bu Lenovo ürünü, T.C. Çevre ve Orman Bakanlığı'nın "Elektrik ve Elektronik Eşyalarda Bazı Zararlı Maddelerin Kullanımının Sınırlandırılmasına Dair Yönetmelik (EEE)" direktiflerine uygundur.

EEE Yönetmeliğine Uygundur.

Trademarks

The following terms are trademarks of Lenovo in the United States, other countries, or both:

Lenovo

The Lenovo logo

ThinkCentre

The ThinkCentre logo

ThinkVision

Microsoft and Windows are trademarks of the Microsoft group of companies.

DisplayPort is a trademark of the Video Electronics Standards Association.

Other company, product, or service names may be trademarks or service marks of others.

Power cords and power adapters

Use only the power cords and power adapters supplied by the product manufacturer. Do not use the ac power cord for other devices.