

# Treasuring your freedom.

---

## Yale Safe User Manual

For models:

YSB/200/EB1

YSB/250/EB1

YSB/400/EB1

YLB/200/EB1

YSM/250/EG1

YSM/400/EG1

YSM/520/EG1

YLM/200/EG1

Please keep manual safe  
for future reference.

## Safe overview

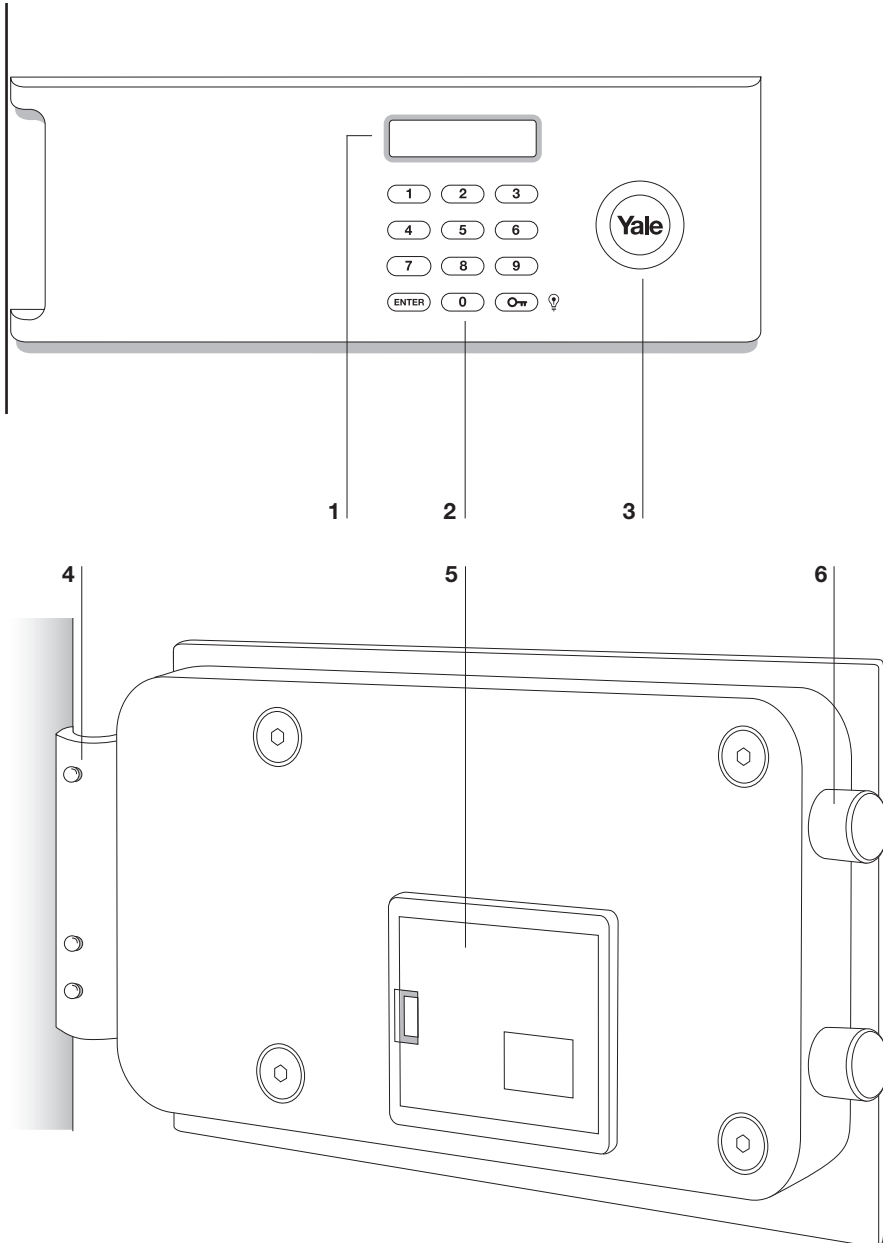

- 1 Display
- 2 Keypad
- 3 Concealed override keyhole
- 4 LED interior lights (on some models)
- 5 Battery compartment
- 6 Locking bolts

## Securing the safe

To reduce the risk of theft it is essential that your safe is securely fixed. Please use the included bolts and secure to a solid concrete floor.

For maximum performance and correct installation a professional locksmith must install the safe.

 This product is heavy. Incorrect installation may result in injury.

## Installing the batteries

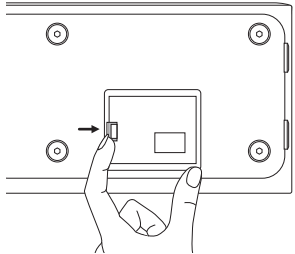
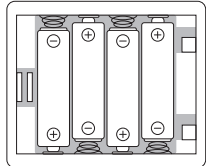
- 1 Follow instructions under "Using the manual override key".
- 2 
- 3 

- 1 Open the safe using the manual override key.
- 2 Remove the battery cover located on the rear of the door.
- 3 Place the batteries according to the illustration at the back of the battery compartment. Once the batteries are installed, close the battery compartment.

Before using your Yale safe you must insert batteries. The safe requires 4 "AA" (1.5V R06) – which are included.

When batteries need changing the display will show **LO-BAT** together with a warning sound when you press **ENTER**.

 Please note, when new batteries are installed the sound and display function are reset to default settings, (code visible and sound on). Your user code is not reset when you change batteries.

# Set/re-set your user code

1 unlock door

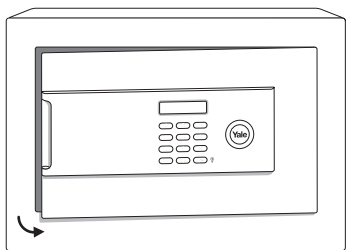

2 ENTER + 3

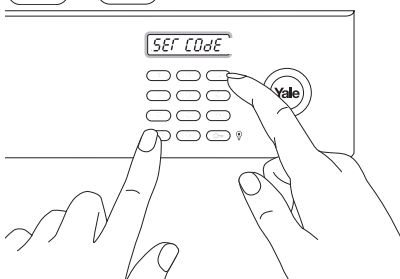

3 code → ENTER → code → ENTER

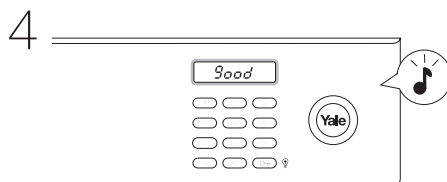
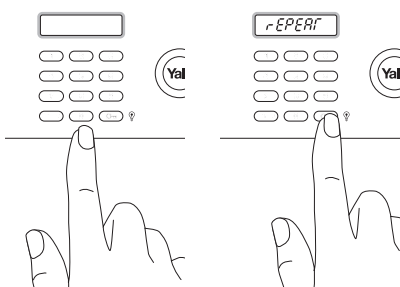

- 1 The code may only be programmed when the safe is unlocked: if necessary use the override key to open the safe.
- 2 Press and hold **ENTER** and simultaneously press **3**. The display will show *SET CODE*.
- 3 Enter the code of your choice (between 3-8 digits) then press **ENTER**. You will now be asked to repeat the code you just entered (the display shows *REPEAT*). Re-enter your code and press **ENTER**.
- 4 A sound and the display *Good* will confirm that you have programmed a new code. If you hear a sound and the display reads *Error*, repeat step 2 and 3.

If you have forgotten your code, use the manual override key to open the safe and re-set the code.

Please note, your user code does not have to be reprogrammed when you change the batteries.

# Opening the safe

1 press ENTER

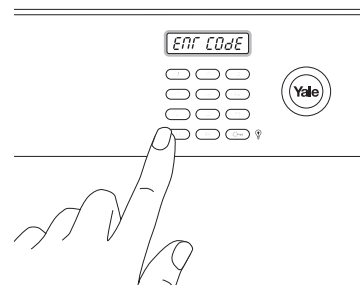

2 code → ENTER

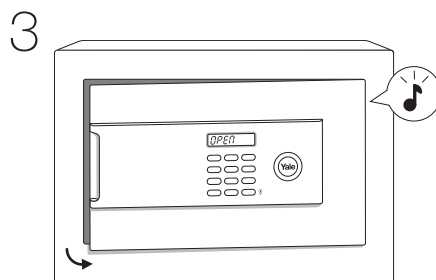
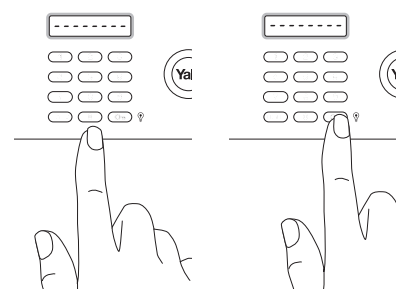

- 1 Press **ENTER**, the display shows *ENT CODE*.
- 2 Enter your user code and press **ENTER**.
- 3 If the code is correct, you will hear a confirmation sound, the display will show *OPEN* and the door will open.

# Closing the safe

1 close door

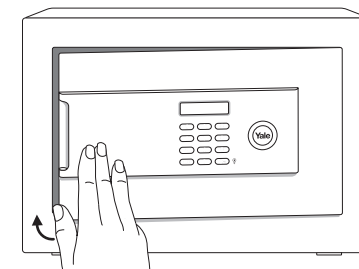

2 ENTER → ENTER

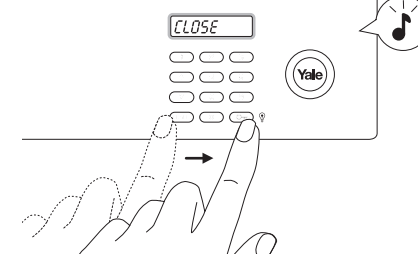

- 1 Close the safe door.
- 2 Press **ENTER** followed by **ENTER**. The bolts engage, locking the door, and the display shows *CLOSE*.

Please note, if the incorrect user code is entered you will hear a beep, the display will show *Error* and the door will not open. If the wrong user code is entered 4 consecutive times an alarm will sound for approximately 1 minute, during which you will not be able to open the safe with the electronic lock.

## Using the manual override key

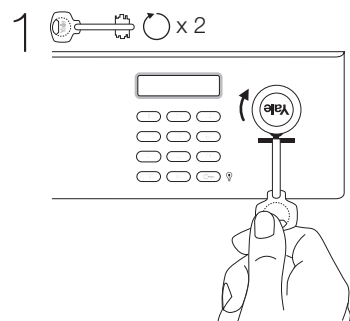

- 1 To open the safe place the key in the key hole behind the Yale logo. The key can only be inserted one way, Yale logo on key head facing down. Turn the key clockwise twice to fully retract the locking bolts.

**⚠** Please do not store the mechanical override keys inside the safe.

**💡** Please note, for security reasons the key can not be removed and the electronic lock is deactivated when the safe is opened using the mechanical override key. To remove the key, you must lock the safe using the key.

## Re-activating the interior light

(Only available on some models)

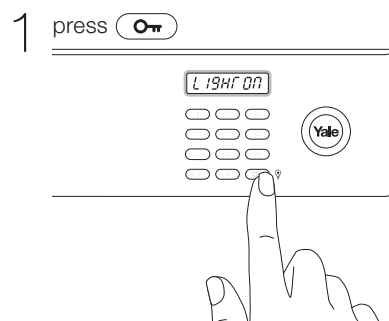

- 1 To re-activate the light press **Ovr**. The display shows *L IGHt ON* and the light will be turned on for another 30 seconds.

The light is automatically activated when the safe door is opened with the electronic keypad. The light can be re-activated at any time.

## Show/hide digits while entering code

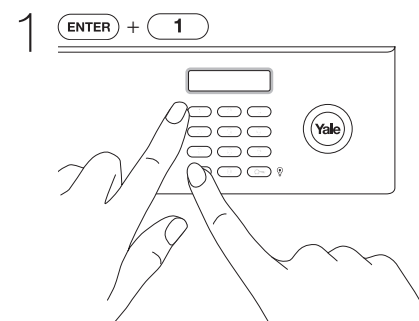

- 1 Press and hold **ENTER** and simultaneously press **1** to change the setting.

- If display *dP-----* shows no input digits will be visible in the display when a code is entered.
- If display shows *dP CODE* the code will be visible in the display when a code is entered.

## Turning sound on/off

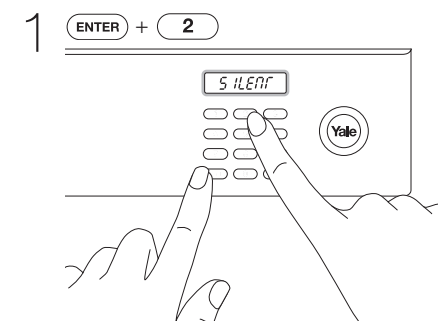

- 1 Press and hold **ENTER** and simultaneously press the **2** to change the setting.

- If display shows *S ILENT* this means that audio feedback when operating the safe is turned off.
- If display shows *BUZZER* this means that audio feedback when operating the safe is turned on.

The safe is delivered with the following items supplied separately inside the box:

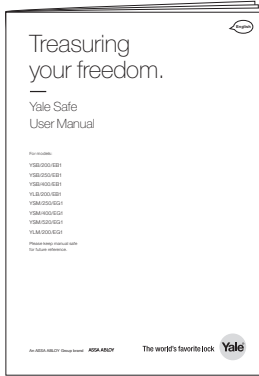

User manual

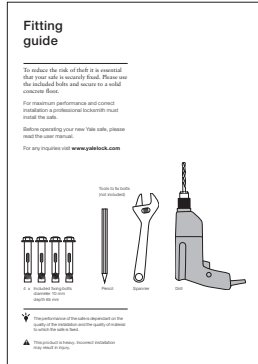

Fitting guide

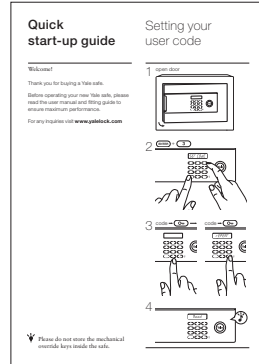

Start up guide

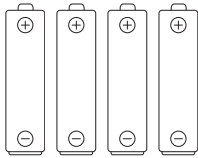

4 x AA batteries

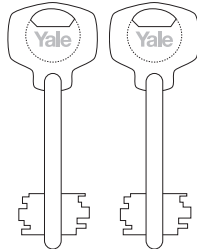

2 x Manual override keys

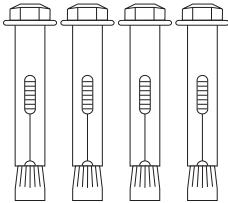

4 x Fixing bolts



4 x Protective floor pads



Recycled materials

For any inquiries visit [www.yalelock.com](http://www.yalelock.com)