

ViewSonic®



VP2785-4K Display User Guide

IMPORTANT: Please read this User Guide to obtain important information on installing and using your product in a safe manner, as well as registering your product for future service. Warranty information contained in this User Guide will describe your limited coverage from ViewSonic Corporation, which is also found on our web site at <http://www.viewsonic.com> in English, or in specific languages using the Regional selection box in the upper right corner of our website. “Antes de operar su equipo lea cuidadosamente las instrucciones en este manual”

Model No. VS16881

Thank you for choosing ViewSonic

As a world leading provider of visual solutions, ViewSonic is dedicated to exceeding the world's expectations for technological evolution, innovation, and simplicity. At ViewSonic, we believe that our products have the potential to make a positive impact in the world, and we are confident that the ViewSonic product you have chosen will serve you well.

Once again, thank you for choosing ViewSonic !



Contents

1. Cautions and Warnings	1
2. Getting Started	4
2-1. Package Contents	5
2-2. The Exterior of the Monitor	6
2-3. Hardware Installation	7
2-4. Quick Installation	14
2-5. Power On	19
3. Adjusting the Screen Image	21
3-1. Using the Control Panel	21
3-2. Monitor Optimization	25
3-3. Driver Installation (Windows 10 Setup)	25
3-4. Setting the Timing Mode	27
3-5. Additional Software Installation (Optional)	28
3-6. Monitor Firmware Update (Optional)	29
3-7. Auto Pivot (Optional)	31
3-8. Colorbration (Optional)	32
4. OSD Menu Introduction	33
4-1. OSD Menu Tree	33
4-2. OSD Menu Explanation	44
4-3. Advanced Settings Explanation	52
4-4. Advanced Settings for Gamers	63
4-5. Monitor Setting Management	64
5. Specifications	66
6. Troubleshooting	68

7. Cleaning and Maintenance	69
Safe Cleaning Practices	69
8. Compliance Information	71
8-1. FCC Compliance Statement	71
8-2. Industry Canada Statement	72
8-3. CE Conformity for European Countries.....	72
8-4. Declaration of RoHS2 Compliance	73
8-5. Indian Restriction of Hazardous Substances	75
8-6. Product Disposal at End of Product Life	75
9. Copyright Information.....	76
10. Service Information.....	77
Product Registration	77
Customer Service	78
Limited Warranty.....	81
Mexico Limited Warranty	86

1. Cautions and Warnings

1. Read these instructions completely before using the equipment.
2. Keep these instructions in a safe place.
3. Heed all warnings and follow all instructions.
4. Sit at least 18" / 45cm from the monitor.
5. When installing the monitor, please leave 10cm of open space around the monitor for ventilation safety purposes.
6. Always handle the display with care when moving it.
7. Exercise caution when removing the rear cover of the monitor. This monitor contains high-voltage parts.
8. Do not use this equipment near water. To reduce the risk of fire or electric shock, do not expose the monitor to rain or moisture.
9. Avoid exposing the monitor to direct sunlight or other sources of sustained heat. Do not install near any heat sources such as radiators, heat registers, stoves, or other devices (including amplifiers) that may increase the temperature of the monitor to dangerous levels.
10. Clean with a soft, dry cloth. If further cleaning is required, see "Cleaning the Display" in this guide for further instructions.
11. Avoid touching the screen. Skin oils are difficult to remove.
12. Do not touch, rub or apply pressure to the monitor screen, as it may permanently damage the screen.
13. Place the monitor in a well-ventilated area. Do not place anything on the display that prevents heat dissipation.
14. Do not place heavy objects on the display, video cable, or power cord.

15. If smoke appears, an abnormal noise, or a strange odor is present, immediately switch the display off and call your dealer or ViewSonic. It is dangerous to continue using the display.
16. Do not attempt to circumvent the safety provisions of the polarized or grounding-type plug. A polarized plug has two blades with one wider than the other. A grounding type plug has two blades and a third grounding prong. The wide blade and the third prong are provided for your safety. If the plug does not fit into your outlet, obtain an adaptor and do not attempt to force the plug into the outlet.
17. When connecting to a power outlet, DO NOT remove the ground prong. Please ensure grounding prongs are NEVER REMOVED.
18. Protect the power cord from being treaded upon or pinched, particularly at the plug, and at the point where it emerges from the equipment. Be sure that the power outlet is located near the equipment so that it is easily accessible.
19. Only use attachments/accessories specified by the manufacturer.
20. Use only with the cart, stand, tripod, bracket, or table specified by the manufacturer, or sold with the equipment. When a cart is used, use with caution when moving the cart/equipment combination to avoid injury from tipping over.
21. Unplug this equipment when it will be unused for long periods of time.



22. Refer all servicing to qualified service personnel. Service will be required when the unit has been damaged in any way, such as: if the power-supply cord or plug is damaged, if liquid is spilled onto or objects fall into the unit, if the unit is exposed to rain or moisture, or if the unit does not operate normally or has been dropped.
23. Excessive sound pressure from ear-/headphones can cause hearing damage /hearing loss.
24. Adjustment of the volume control as well as the equalizer may increase the ear-/ headphones output voltage and therefore, the sound volume level.
25. The factors influencing the ear-/headphones output other than those specified by the manufacturer (e.g. operating system, equalizer software, firmware, driver) may increase the ear-/ headphone output voltage and therefore, the sound volume level.
26. **NOTICE: MONITOR MAY OVERHEAT AND SHUT DOWN!**
If monitor shut down, please reboot your monitor. After reboot, test the new Max Refresh rate by enabling it in the NVIDIA Control Panel.
If you don't see an image, please disconnect the DP cable and use the monitor OSD to try again with a safer Max Refresh.

2. Getting Started

Should problems arise and the product you have purchased needs to be returned for any reason, please keep the original packaging, registration form, and receipt. Having these items will make it easier for you to verify your product and repair, refund and/or return your product to you.

If you have any problems with your product or questions that have not been addressed in the User Guide, please contact customer service for help.

Important! Save the original box and all packing material for your future shipping needs.

NOTE: The word “Windows” in this user guide refers to Microsoft Windows operating system.

2-1. Package Contents

Your monitor package includes:

- Monitor
- Power cord
- Video cable¹
- USB cable
- Type-C cable
- Quick Start Guide
- ViewSonic CD
 - User Guide
 - INF/ICM files²
 - Registration information
 - Additional software (Optional)

NOTE:

¹ The video cables included in your package may vary depending on your country. Please contact your local reseller for more information.

² The INF file ensures compatibility with Windows operating systems, and the ICM file (Image Color Matching) ensures accurate on-screen colors. ViewSonic recommends that you install both the INF and ICM files.

2-2. The Exterior of the Monitor

A. Front

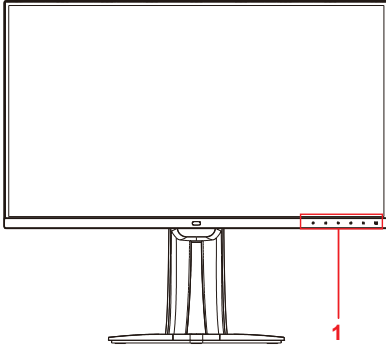

B. Left and Right

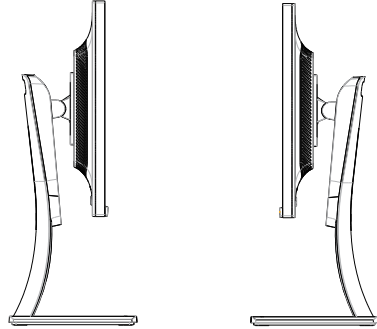

C. Rear

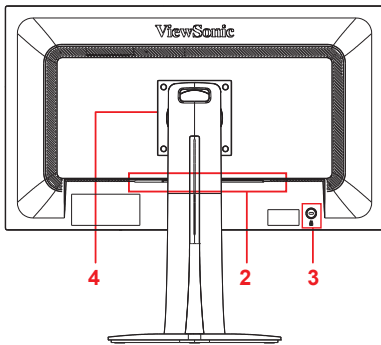

1. Control panel (Expanded in 3-1)
2. I/O port (input/output) This area should include all I/O connection options, as well as the power input connector (Expanded in 2-4)
3. Kensington security slot (Expanded in 2-3 section G)
4. This is the VESA wall mounting area on the back of the moitor*. For the VESA wall mounting installation steps, please see 2-3 section F for additional instructions.
*VESA wall mount capability varies depending on model: some models will not have VESA wall mounting capability.

2-3. Hardware Installation

A. Base Attachment Procedure

1

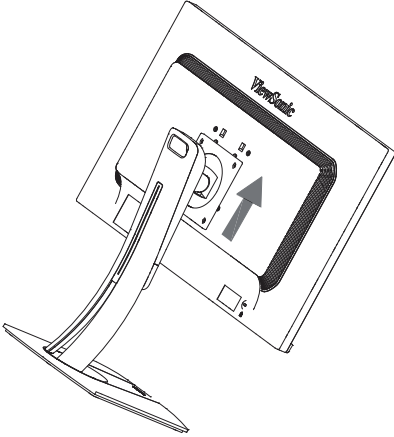

2

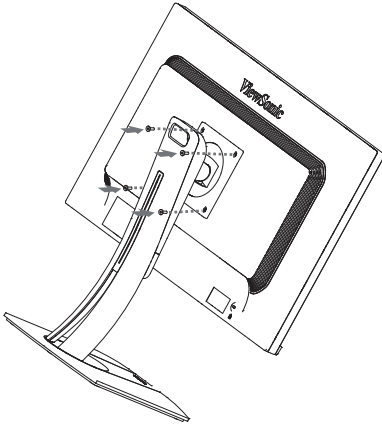

3

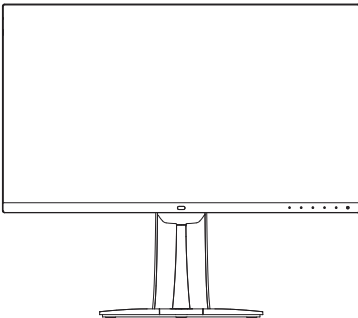

B. Base Removal Procedure

1

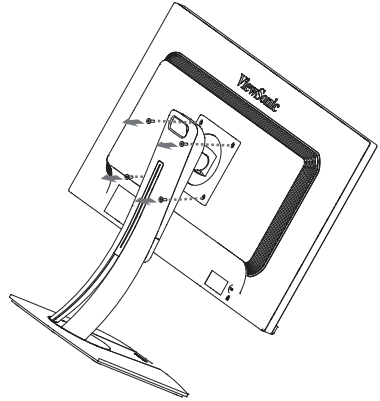

2

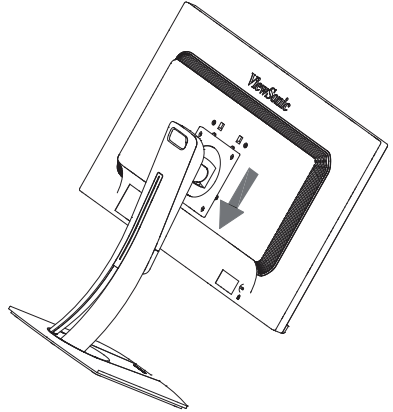

3

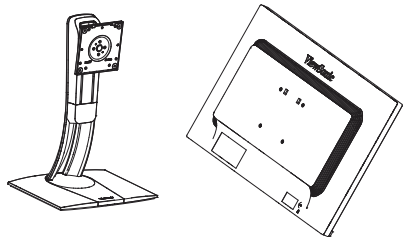

C. Adjusting the Monitor's Height

- Push the top of the monitor downward until it is at the desired viewing height for use.
- You can also pull the monitor back up, to the desired viewing height for use.

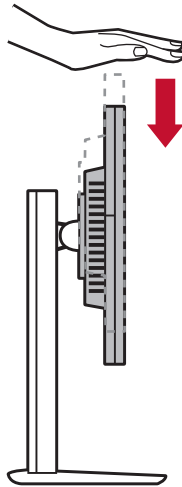

D. Adjusting the Angle

- After adjusting the monitor's height, stand in front of the monitor so it is centered in front of you.
- The angle of the screen can be adjusted by moving the panel, angling it forward or back. It can be adjusted from -5° to 21° for a flexible, comfortable viewing experience*.

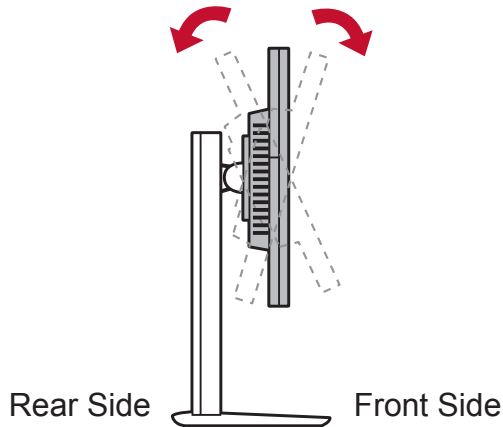

*Adjustment angles vary depending on each individual model.

E. Pivot Feature

1. Lift/raise the monitor as high as it can go (max height).

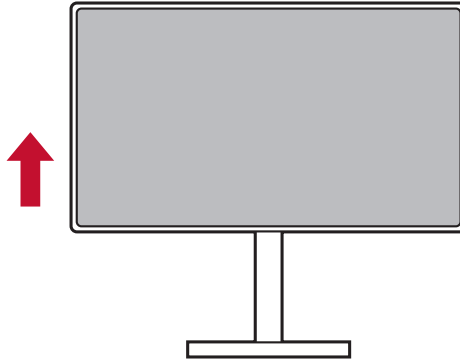

2. Adjust the monitor, angling the top back and pull the bottom forward (see the below picture for reference).

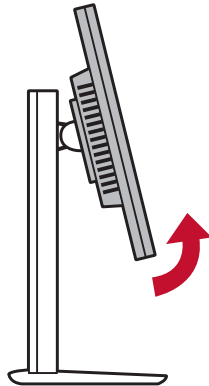

3. Rotate the monitor clockwise and counterclockwise, (see the below picture for reference).

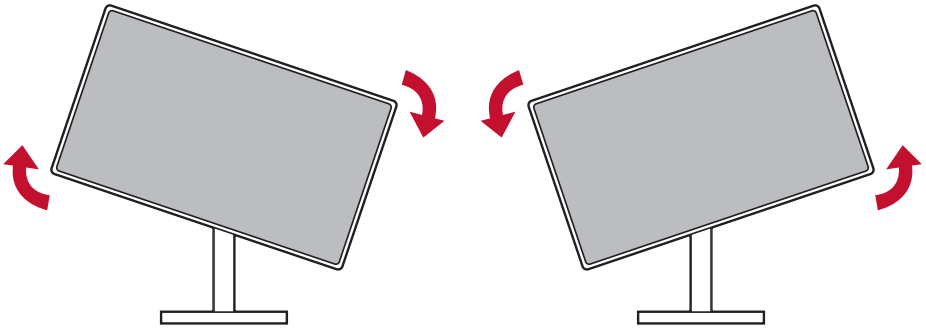

4. Finish the monitor installation by fully rotating the monitor 90°(see the below picture for reference).

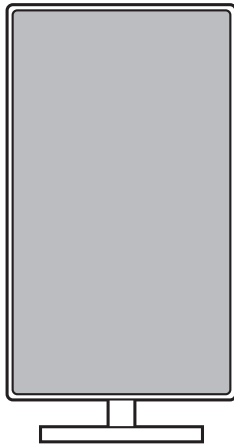

F. Wall Mounting (Optional)

NOTE: For use only with a UL Listed Wall Mount Bracket.

To obtain a wall-mounting kit or height adjustment base, contact ViewSonic® or your local dealer. Refer to the instructions that come with the base mounting kit. To convert your display from a desk-mounted to a wall-mounted display, do the following:

1. Find VESA compatible wall-mounting kit which meets the quaternions below,

Max Loading	Hole pattern (W x H; mm)	Interface Pad (W x H x D)	Pad Hole	Screw Q'ty & Specification
14kg	100mm x 100mm	115 mm x 115 mm x 2.6 mm	Ø 5mm	4 piece M4 x 10mm

2. Verify that the power button is turned Off, then disconnect the power cord.
3. Lay the display face down on a towel or blanket.
4. Remove the base. (Screws removal might be required.)
5. Attach the mounting bracket from the wall mounting kit using screws of the appropriate length.
6. Attach the display to the wall, following the instructions in the wall-mounting kit.

G. Using the Kensington Lock

The Kensington security connector is located on the back side of the monitor. For more information on installation and usage please visit the Kensington website at <http://www.kensington.com>.

Below is an example of setting up the Kensington lock on a table for your reference.

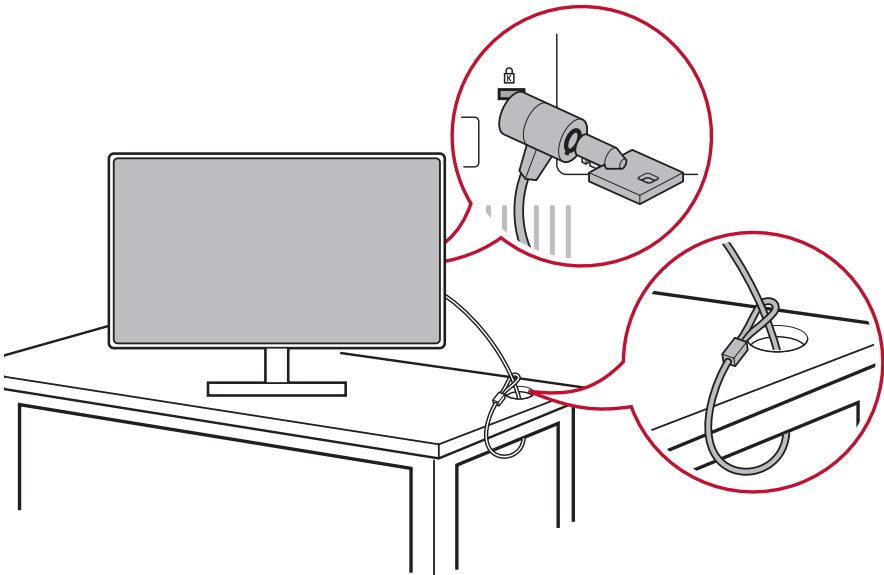

2-4. Quick Installation

Connect Video Cable

1. Make sure both the LCD monitor and computer are turned OFF.
2. Remove rear panel covers if necessary.
3. Connect the video cable from the LCD monitor to the computer. Macintosh users: Models older than G3 require a Macintosh adapter. Attach the adapter to the computer and plug the video cable into the adapter.
To order a ViewSonic® Macintosh adapter, contact ViewSonic Customer Support.

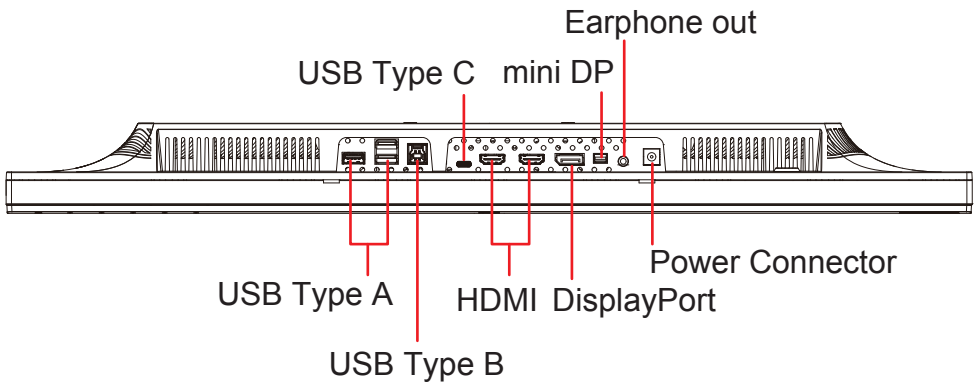

A. Power Cable (and AC/DC adapter if required)

Connect the female connector of AC power cord to the power connector of monitor, and the AC plug of AC power cord to the AC outlet.

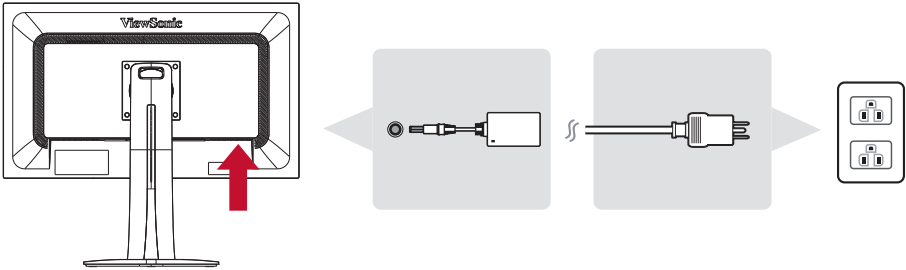

B. Video and Audio Cable

Connect one end of the DisplayPort cable to the DisplayPort or mini DP connector on the rear of the monitor*. And connect the other end of the DisplayPort cable to the DisplayPort or mini DP connector on the computer.

For a computer or other source device with HDMI output, connect the HDMI cable to the HDMI connector on the rear of the monitor and the HDMI port of the computer or source device.

For a MAC with Thunderbolt output, connect the mini DP end of the “mini DP to DisplayPort cable” to the Thunderbolt output of MAC. And connect the other end of the cable to the DisplayPort connector on the rear of the monitor.

Connect the one end of the audio cable to the audio out connector on the rear of the monitor. And connect the other end to the headphone, speaker bar or sound bar.

* Please do not connect the DP out on the monitor to the DisplayPort or mini DP connector on the computer. DP out is used for daisy chain connection (Explained in section D)

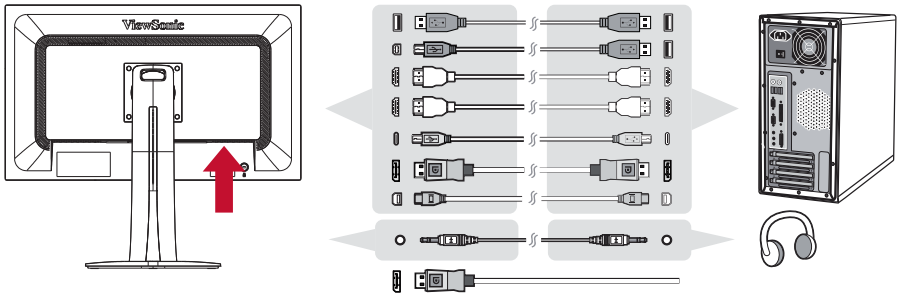

C. USB Cable

Connect the B type connector of USB cable to the USB 3.0 upstream port on the rear of the monitor. And connect the A type connector of USB cable to the USB downstream port on the computer.

A type

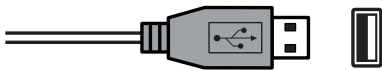

B type

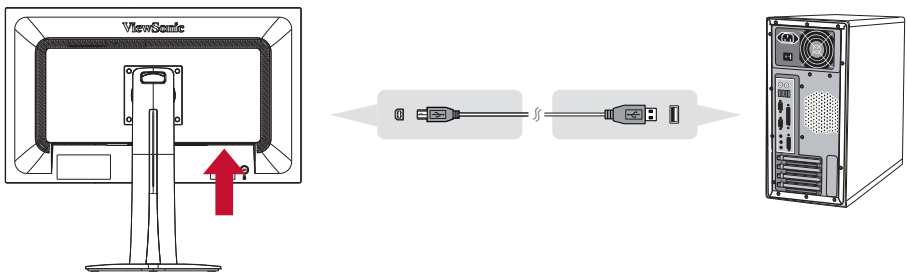
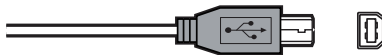

Type-C connection of specific VP series monitor

Some specific models have Type-C port to support power charging, USB Hub and Displayport video input.

Please make sure your Type-C output device and cable support Video signal transmission. Some Type-C device and cable only support power charging and data transfer function. Or you can contact ViewSonic Customer Support to order an Type-C Video cable.

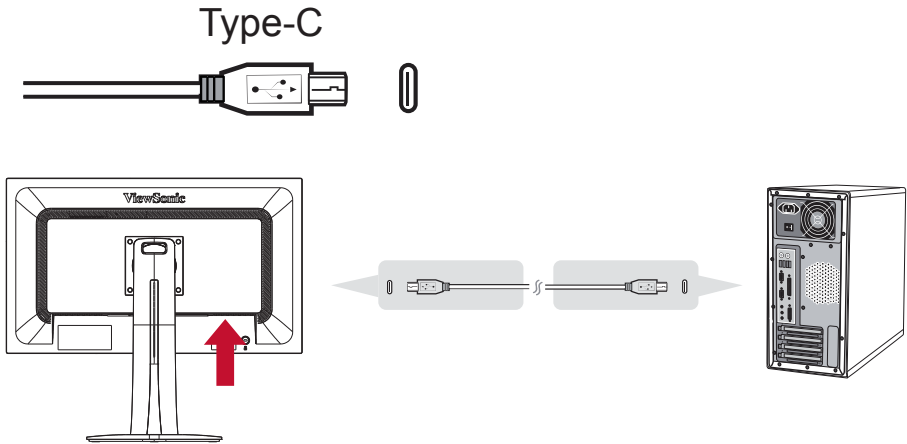

D. DisplayPort MST daisy chain connection

With DisplayPort Multi-Stream Transport support, you can daisy chain connect up to four monitors*. If your Graphic Card is DP 1.2 compliant and support MST mode, connect one end of DP cable to the DP output of the PC/Laptop. Connect the other end of DP cable to the DP input or mini DP input connector on the rear of the monitor. Use another DP cable to connect DP output of the 1st monitor and DP input of the 2nd monitor.

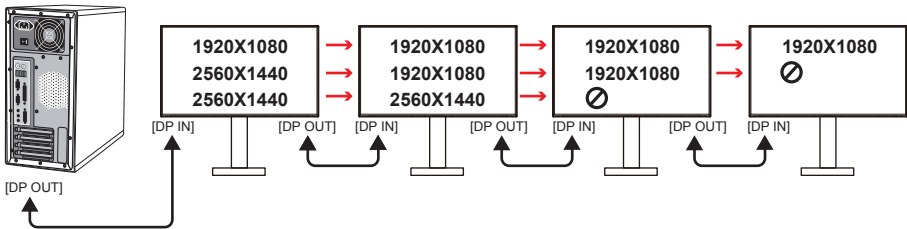
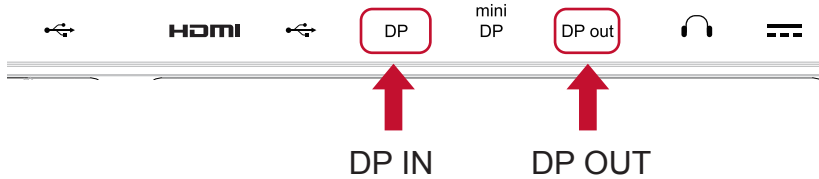

*The number of monitors you can connect through DisplayPort daisy chain is up to four monitors, depends on the monitor resolution. For example, you can connect 4*VP2468 (1920x1080) or 2*VP2771 (2560x1440) or 1*VP2771+2*VP2468.

*To speedup DisplayPort daisy chain handshaking process, suggest to disable Input source auto detect function. (Expanded in 2-5)

*The MST daisy chain function is not supported by VP2785-4K.

2-5. Power On

Turn On LCD Monitor and Computer

Turn ON the LCD Monitor, then turn ON the computer. This particular order (LCD monitor before computer) is important.

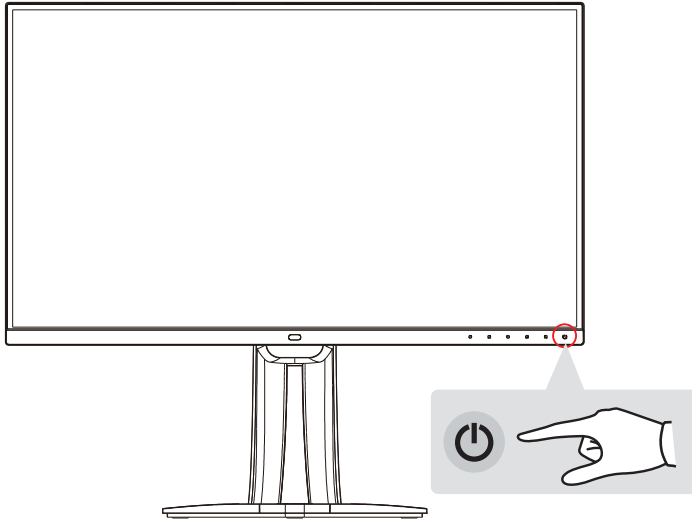

NOTE: Windows users may receive a message asking them to install the INF file. To access the file, please insert ViewSonic CD into Computer's CD drive and locate within the following directory “:\CD\vsfiles”.

If your computer does not have a CD-ROM drive, please refer to Customer Support page.

Windows Users: Set the Timing Mode

For instructions on changing the resolution and refresh rate, see the graphics card's user guide.

DisplayPort 1.2 mode set to On

*Highlight and select the DISPLAYPORT1.2 function

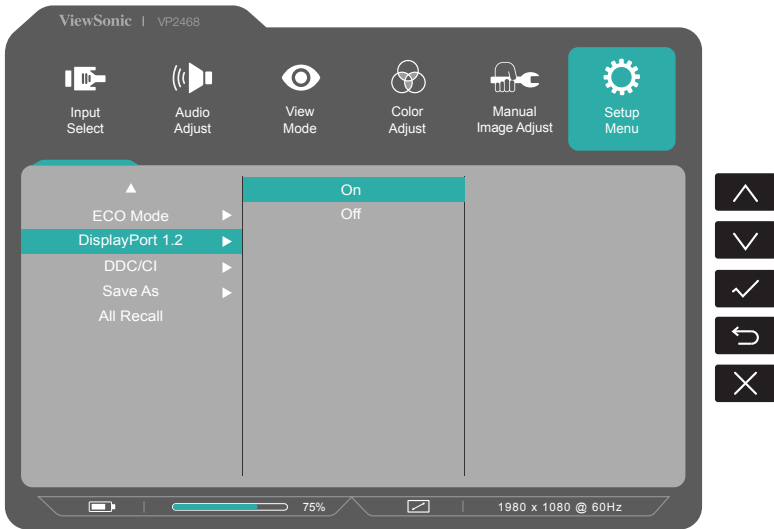

- * Enable MST mode from graphic card (if required)
- * Link displays through DP and DP out as the examples below
- * Bandwidth up to 5.4G x4 Lans

3. Adjusting the Screen Image

3-1. Using the Control Panel

Use the buttons on the front or rear control panel to display and adjust OSD.....

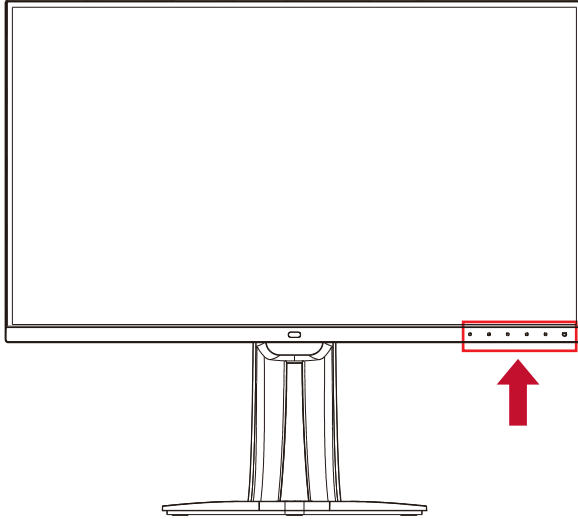

Bezel & OSD symbol explanation

The bezel symbol explanation is stated below:

Standby Power On/Off



NOTE: Power light
Blue = ON
Orange = Power Saving



Display the Menu by pressing any Function button.

The OSD Menu and OSD Quick-Menu Symbol explanations and their functional uses are stated below.



Activation symbol to turn the various modes on when operating the menu system.



Activation symbol to exit, go back or deactivate the desired function that is selected.



Scrolls through menu options and adjusts the monitor controls.



Symbol used to go back or revert back to the previously selected menu



Information shortcut select button, which gives users access to the information of the monitor currently in use.



Main menu icon that allows users to access the main menu. Hold down the icon for a few seconds to turn off the main menu



Left and right icons toggle your selected choice horizontally.











OSD quick menu selector, which increases or decreases the currently selected function

The Quick-Menu symbol explanation is stated below:



1. To display the Quick Menu, press any one of the button on the slim bezel [●].
NOTE: All OSD menus and adjustment screens disappear automatically after about 15 seconds. This is adjustable through the OSD timeout setting in the setup menu.
2. After pressing one of the squares, you will see options appear for quick access.

				
Preset Color Option	Contrast/ Brightness Option	Input Select Option	Main Menu Access	Exit

3. After the desired menu control is selected, use the     symbols to navigate and adjust the monitor to your specified preference.
Each menu function is explained in further detail in 4-2 OSD Explanation.
4. To save the adjustments and exit, press [X] until the OSD disappears.

3-2. Monitor Optimization

- Adjust the computer's graphics card to support a recommended timing mode (refer to "Specifications" page for recommended resolution setting specific to your LCD monitor). To find instructions on "changing the refresh rate", please refer to the graphics card's user guide.

3-3. Driver Installation (Windows 10 Setup)

In order to install the driver, first connect your monitor to your PC, boot up your PC (make sure to first turn on the monitor first) and when the PC has finished booting up, your PC should auto- detect the monitor.

If your monitor came with a ViewSonic driver installation CD, now is the time to insert the CD into your CD-ROM and follow the steps when prompted. If the CD does not properly install the driver, please download the driver from the ViewSonic website or visit a ViewSonic service center. If your PC did not come with an installation CD, your PC will automatically install the monitor driver, recognizing your ViewSonic monitor.

To ensure auto-detection is successful, go to 'Advanced Display Settings' under your system 'Display Settings' (screen resolution) window. There you can verify your ViewSonic monitor has been recognized by your PC in the 'Color Management' section of your advanced settings.

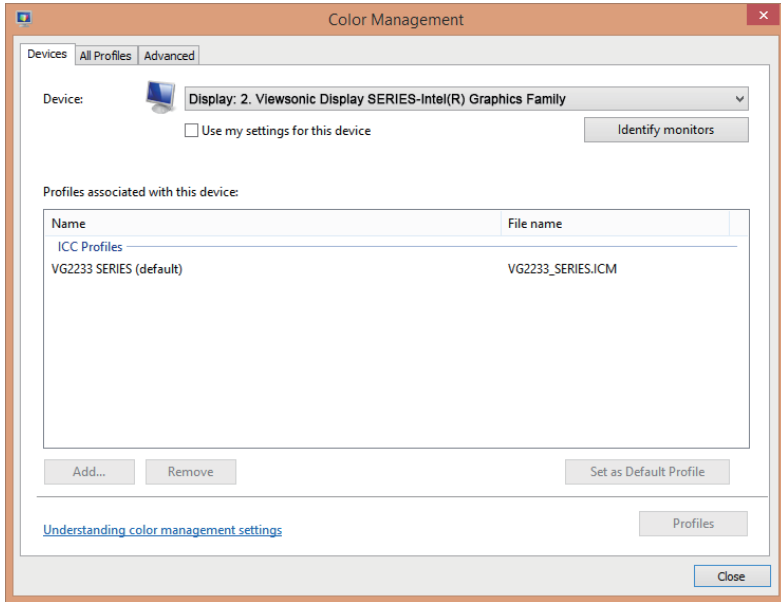

If your PC has not auto-detected the monitor, but is still functioning, you can restart your computer and follow the steps above again. It is not imperative for your computer to detect the monitor for normal use, but it is recommended.

If you encounter additional problems or have questions, please contact Customer Support.

3-4. Setting the Timing Mode

Setting the timing mode is important for maximizing the quality of the screen image and minimizing eye strain. The timing mode consists of the resolution (example 1920 x 1080P) and refresh rate (or vertical frequency; example 60 Hz). After setting the timing mode, use the OSD (On-screen Display) controls to adjust the screen image.

For optimal picture quality, please use the recommended timing mode specific to your LCD monitor listed on the “Specification” page.

To set the Timing Mode:

- Please see your graphics card manager for adjusting the resolution and refresh rate.

Set up your widescreen LCD

Set your monitor resolution to its native resolution to get the best experience possible, with brilliant color and crisp text. Here is how:

1. Go to your display resolution settings window (each operating system will have a different process to get there).
2. Next, adjust the display resolution setting to match your monitor’s native resolution. This will provide you with your best usage experience.

If you have difficulty setting the resolution or you do not see 1920x1080 as an available option, you may need a newer video card driver. Contact your computer or video card manufacturer to obtain the latest driver.

3-5. Additional Software Installation (Optional)

1. Load the ViewSonic CD on your CD/DVD drive.
2. Double click on the "Software" folder and choose an application, if desired.
3. Double click on the .exe file or .pkg file and follow the onscreen instructions to complete the simple installation for each additional software/application.
4. If your PC did not come with CD/DVD drive, please visit <http://color.viewsonic.com> for more VP series information. You can download VP exclusive applications from the website.

3-6. Monitor Firmware Update (Optional)

For the best display performance and to resolve any known issues, it is best to keep your monitor updated with the latest firmware version. With the USB cable and firmware update tool, you can easily update your monitor firmware any time.

Step1. Check and download the Firmware Update Tool with latest firmware version for your monitor from <http://color.viewsonic.com/support/software/>

Step2. Make sure your monitor USB upstream port has been connected to the PC USB downstream port. (Refer to 2-4. section C for more detail.)

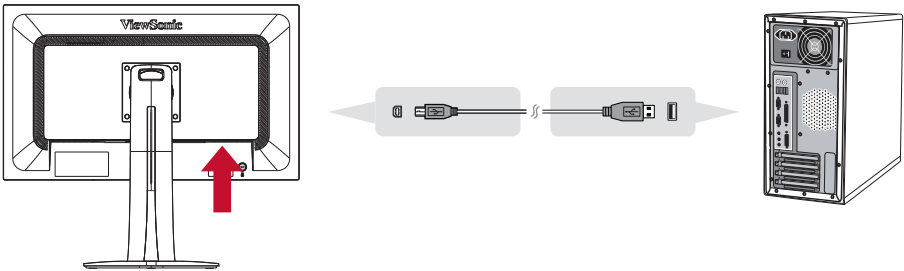

Step3. Unzip the downloaded Firmware Update Tool, double click on the .exe file or .pkg file and follow the onscreen instructions to complete the simple installation.

Step4. Launch the Firmware Update Tool, the application will auto detect and verify your monitor model and current firmware version. Click Update to upgrade your monitor firmware.

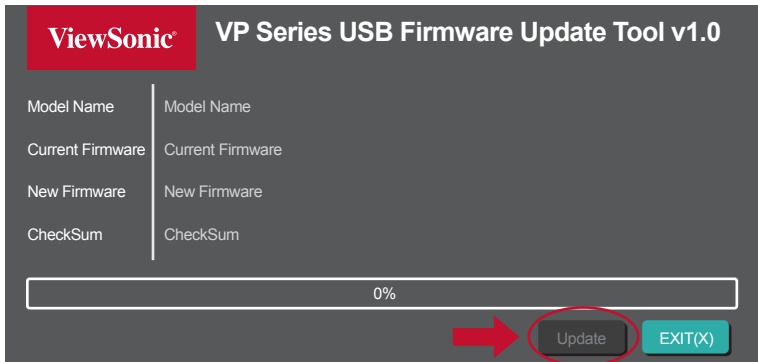

Note: The update procedure will take a few minutes, please do not turn off the power of your PC and monitor. Disconnecting the USB connection will cause the update fail too.

3-7. Auto Pivot (Optional)

With the Auto Pivot application, the operating system can detect and adjust the image's orientation on the screen automatically when pivoting the screen vertically or horizontally. The application installation file is in the software folder of ViewSonic CD. Or you can check and download the latest version Auto Pivot application from <http://color.viewsonic.com/support/software/>

Note: Before applying the Auto Pivot function, please make sure monitor DDC/CI is set to On.

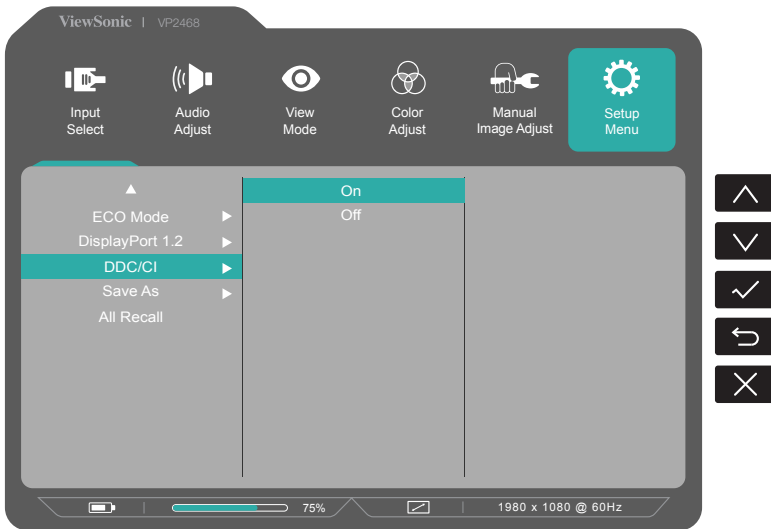

3-8. Colorbration (Optional)

To ensure long-term color accuracy, some specific models support hardware color calibration function. The monitor comes with Colorbration application. The application installation file is in the software folder of ViewSonic CD. Or you can download the latest version from <http://color.viewsonic.com/support/software/>

Standard monitor packing does not contain the color sensor which Colorbration application need to work with.

ViewSonic's Colorbration kit includes the CS-XRi1 color sensor, which has been co-developed with X-Rite to provide the best solution for displaying long-term color accuracy. CS-XRi1 is X-Rite's next generation colorimeter, which utilizes a redesigned optical system, filter technology, calibration architecture, and intelligent form factor to be paired with Viewsonic's Colorbration application to deliver unrivaled color accuracy, repeatability, and device longevity.

Note: Best with ViewSonic CS-XRi1, compatible with X-Rite i1Display Pro and i1 Pro 2.

4. OSD Menu Introduction

4-1. OSD Menu Tree

For an explanation of the OSD tree and pertaining functions, please refer to the 4-2 OSD explanation below. The OSD tree visually represents the complete OSD menu that can be accessed by your monitor. If you aren't sure where an option/function is or cannot locate a specific feature, please utilize the OSD tree below.

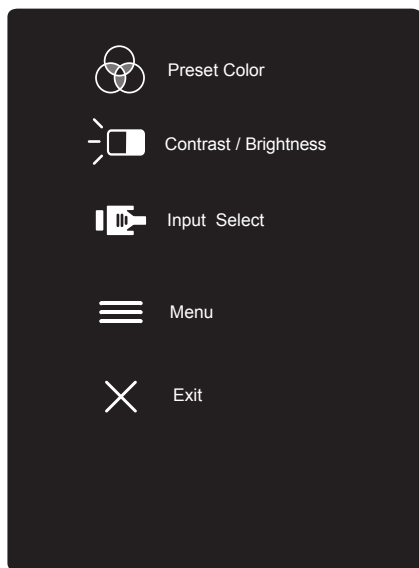

Startup Menu	
Preset Color	Adobe RGB
	sRGB
	EBU
	DCI-P3
	SMPTE-C
	REC709
	DICOM SIM
	I Phone(DCI-P3)
	CAL 1
	CAL 2
Contrast/Brightness	CAL 3
	CUSTOM
Input Select	(-/+ , 1~100)
	mini DP
	DISPLAYPORT
	HDMI 1
	HDMI 2
Menu	Type C
	Refer to Menu OSD Table for detail items
Exit (OSD off)	

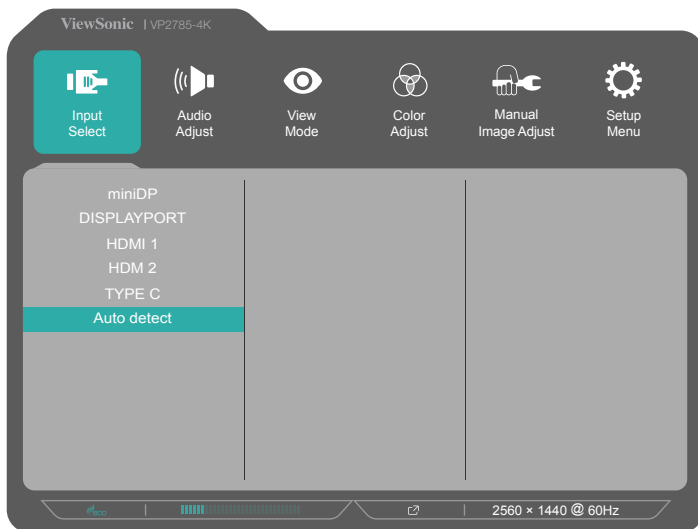

Menu				
Input Select	mini DP			
	DISPLAYPORT			
	HDMI 1			
	HDMI 2			
	Type C			
	Auto detect	On		
Audio Adjust	Volume	(-/+ , 0~100)		
	Mute	On		
	Audio Input	Off		
		Mini DP		
		DisplayPort		
		HDMI 1		
HDMI 2				
Type C				

Menu

ViewMode	Off				
	Game	FPS 1			
		FPS 2			
		RTS			
		MOBA			
	Movie				
	Web				
	Text				
	MAC	UltraClear			
	Designer	CAD/CAM	Ultra Clear	(-/+, 0~10)	
			Advanced Sharpness	(-/+, 0/25/50/75/100)	
			Advanced Gamma	(-/+, 1.8/2.0/2.2/2.4/2.6)	
		Animation	Ultra Clear	(-/+, 0~10)	
			Advanced Sharpness	(-/+, 0/25/50/75/100)	
			Black stabilization	(-/+, 0~10)	
		Video Edit	Ultra Clear	(-/+, 0~10)	
			Advanced Sharpness	(-/+, 0/25/50/75/100)	
			Advanced Gamma	(-/+, 1.8/2.0/2.2/2.4/2.6)	
		Photographer	Retro	Ultra Clear	(-/+, 0~10)
				Advanced Sharpness	(-/+, 0/25/50/75/100)
				Advanced Gamma	(-/+, 1.8/2.0/2.2/2.4/2.6)
	Photo		Ultra Clear	(-/+, 0~10)	
			Advanced Sharpness	(-/+, 0/25/50/75/100)	
			Advanced Gamma	(-/+, 1.8/2.0/2.2/2.4/2.6)	
			TruTone	(-/+, 0~100)	
	Landscape		Ultra Clear	(-/+, 0~10)	
			Advanced Sharpness	(-/+, 0/25/50/75/100)	
			Advanced Gamma	(-/+, 1.8/2.0/2.2/2.4/2.6)	
TruTone			(-/+, 0~100)		

Menu

ViewMode	Photographer	Portrait	Ultra Clear	(-/+, 0~10)
			Advanced Sharpness	(-/+, 0/25/50/75/100)
			Advanced Gamma	(-/+, 1.8/2.0/2.2/2.4/2.6)
			TruTone	(-/+, 0~100)
			Skin Tone	(-/+, 0~10)
			Black stabilization	(-/+, 0~10)
		Mono Chrome	Advanced Sharpness	(-/+, 0/25/50/75/100)
			TruTone	(-/+, 0~100)
Color Adjust	Contrast/ Brightness	Contrast	(-/+, 0~100)	
		Brightness	(-/+, 0~100)	
	Color Format	Auto		
		RGB(Full Range)		
		RGB(Limited Range)		
		YUV(Full Range)		
		YUV(Limited Range)		
	Standard Color	Adobe RGB		
		SRGB		
		EBU		
		DCI-P3		
		SMPTE-C		
		REC 709		
		DICOM SIM		
		I-Phone (DCI-P3)		
	Custom	Color Temperature	Panel Default	
			Bluish	9300K
			Cool	7500K
			Native	6500K
			Warm	5000K
			User	
Gamma		Off		
		1.8		
		2.0		
		2.2		
		2.4		
		2.6		
Black Stabilization	(-/+, 0~10)			
Advanced DCR	(-/+, 0/25/50/75/100)			

Menu

Color Adjust	Custom	Gain	Red	(-/+, 0~100)
			Green	(-/+, 0~100)
			Blue	(-/+, 0~100)
		Offset	Red	(-/+, 0~100)
			Green	(-/+, 0~100)
			Blue	(-/+, 0~100)
		Hue	Red	(-/+, 0~100)
			Green	(-/+, 0~100)
			Blue	(-/+, 0~100)
			Cyan	(-/+, 0~100)
			Magenta	(-/+, 0~100)
		Saturation	Yellow	(-/+, 0~100)
			Red	(-/+, 0~100)
			Green	(-/+, 0~100)
			Blue	(-/+, 0~100)
			Cyan	(-/+, 0~100)
		x, y Adjustment	Magenta	(-/+, 0~100)
			Yellow	(-/+, 0~100)
	White		x,y x(0.000),y(0.000)	
	Red		x,y x(0.000),y(0.000)	
	Color Calibration	Green	x,y x(0.000),y(0.000)	
		Blue	x,y x(0.000),y(0.000)	
		Recall		
		CAL 1		
CAL 2				
CAL 3				
Calibration Notice		Remind Schedule (-/+, 0/1/10/100/200/500/1000/2000/3000)		
	Counter Hour			
Manual Image Adjust	Sharpness	(-/+, 0~100)		
		Aspect Ratio		
		4:3		
	Overscan	Full Screen		
		On		
	Low Input lag	Off		
		Off		
		Advanced		
		UltraFast		

Menu

Manual Image Adjust	Response Time	Standard		
		Advanced		
		Ultra Fast		
	Blue Light Filter	(-/+ , 0~100)		
	Uniformity	On		
		Off		
	Film Mode	On		
		Off		
HDR10	On			
	Off			
Setup Menu	Language	English		
		Français		
		Deutsch		
		Español		
		Italiano		
		Suomi		
		Русский		
		Türkçe		
		日本語		
		한국어		
		繁體中文		
		简体中文		
		Resolution Notice	On	
	Off			
	Information			
	OSD Timeout	(-/+ , 5/15/30/60)		
	OSD Background	On		
		Off		
	OSD Pivot	Auto		
		0°		
+90°				
-90°				
180°				
Power Indicator	30 Minutes			
	On			
	Off			

Menu

Setup Menu	Auto Power Off	On		
		Off		
	Sleep	30 Minutes		
		45 Minutes		
		60 Minutes		
		120 Minutes		
		Off		
		Off		
	Ambient Light Sensor	On		
		Off		
		HAL Luminance	(-/+, 0~100)	
		MAL Luminance	(-/+, 0~100)	
		LAL Luminance	(-/+, 0~100)	
	Presence Sensor	Off		
		Level 1		
		Level 2		
		Level 3		
	Multi-Picture	Off		
		Quad Windows	Top-Left	miniDP
				DisplayPort
				HDMI 1
				HDMI 2
				Type C
		Quad Windows	Top-Right	miniDP
				DisplayPort
				HDMI 1
				HDMI 2
Type C				
Quad Windows		Bottom-Left	miniDP	
			DisplayPort	
			HDMI 1	
			HDMI 2	
	Type C			

Menu

Setup Menu	Multi-Picture	Quad Windows	Bottom-Right	miniDP
				DisplayPort
				HDMI 1
				HDMI 2
				Type C
		PBP Top-Bottom	Top Source	miniDP
				DisplayPort
				HDMI 1
				HDMI 2
				Type C
		PBP Top-Bottom	Bottom Source	miniDP
				DisplayPort
				HDMI 1
				HDMI 2
				Type C
		PBP Left-Right	Left Source Select	Swap
				miniDP
				DisplayPort
				HDMI 1
				HDMI 2
			Type C	
			Right Source Select	miniDP
				DisplayPort
				HDMI 1
HDMI 2				
Type C				
Swap				
PIP	PIP Source Select	miniDP		
		DisplayPort		
		HDMI		
		Type C		
	PIP Position	PIP H Position(-/+, 0~100) PIP V Position(-/+, 0~100)		
PIP Size	(-/+, 0~100)			
Swap				

Menu

Setup Menu

Setup Menu	Multi-Picture	Dual Color	AdobeRGB	
			sRGB	
			EBU	
			SMPTE-C	
			REC709	
			DICOM	
			I Phone (sRGB)	
			Native	
			CAL 1	
		Dual Color	CAL 2	
			CAL 3	
			Custom	
			FPS 1	
			FPS 2	
			RTS	
			MOBA	
			Movie	
			Web	
			Text	
			MAC	
			Mono	
			CAD/CAM	
		Animation		
		Video Edit		
	ECO Mode	Standard		
		Optimize		
		Conserve		
		Energy saving	On	
			Off	
	DisplayPort 1.2	On		
		Off		
	HDMI2.0	On		
Off				

Menu

Setup Menu	USB 3.1	On	*Trun on / auto control accept USB 2.0 or USB 3.1 Gen1	
		Off	* Turn off /Swtich to USB 2.0 / 4K60Hz	
	DDC/CI	On		
		Off		
	Save As	User 1		
		User 2		
		User 3		
		Recall		
	Backlight Sensor	On	Auto Control	
		Off	User Define	
	All Recall			

4-2. OSD Menu Explanation

NOTE: The OSD menu items listed in this section indicate the entire OSD items of all models. Some of these items may not exist in your product OSD. Please disregard OSD menu item explanations if they do not exist in your OSD Menu. Please refer to the 4-1 OSD Tree (above), for your monitor's available OSD menu items. Please refer to the OSD explanation below (in alphabetical order), for a clearer explanation of what each function does.

A Advanced DCR

Advanced DCR technology automatically detects the image signal and intelligently controls the backlight brightness and color, to improve on the ability to make the black blacker in a dark scene, and make the white whiter in a bright environment.

Audio adjust

Adjusts the volume, mutes the sound, or toggles between inputs if you have more than one source.

Auto detect

If current input source is no signal, monitor will automatically switch to next input option. This function on some model is disabled by default.

B Backlight sensor

1. Maintains AdobeRGB, sRGB, and DICOM brightness stability for extended periods of time.
2. Typically, monitors take 30 minutes or more for brightness, chromaticity, and tone characteristics to stabilize; VP2785-4K can achieve stabilization in a mere three minutes.
3. For standard color and native modes, the backlight sensor will automatically adjust and maintain brightness to meet user defined brightness criteria, such as 120Cd/m², 160Cd/m², or 230Cd/m².

B Black stabilization

ViewSonic's Black stabilization provides heightened visibility and detail by brightening dark scenes.

Blue light filter

Adjusts the filter that blocks high-energy blue light for a safer experience for our users.

Brightness

Adjusts background black levels of the screen image.

C Color space

Allows users to choose which color space they would like to use for monitor color output (RGB, YUV).

Color temperature

Allows users to select specific color temperature settings to further customize their viewing experience.

Panel Default	Panel original status
Bluish	9300K
Cool	7500K
Native	Native is a default color temperature. Recommend for general graphic design and regular use.
Warm	5000K

Contrast

Adjusts the difference between the image background (black level) and the foreground (white level).

C Color calibration

User can calibrate the monitor by ViewSonic Colorbration application with specific color sensor.

Options	Sub	Explanation
CAL1		Display with the 1 st user calibration mode
CAL2		Display with the 2 nd user calibration mode
CAL3		Display with the 3 rd user calibration mode
Calibration Notice	Reminder Schedule	Set the schedule of calibration remind message
	Counter	To show the time accumulate from last calibration
Recall		Reset the Color Calibration related settings to default

Color format

Monitor can detect the input signal color format automatically. You can manually change the color format options to fit the correct color format range if the colors are not displayed correctly.

Options	Explanation
Auto	Monitor automatically recognizes the color format and black white levels.
RGB (Full Range)	The input signal color format is RGB and the black white level is full
RGB (Limited Range)	The input signal color format is RGB and the black white level is limited
YUV (Full Range)	The input signal color format is YUV and the black white level is full
YUV (Limited Range)	The input signal color format is YUV and the black white level is limited

F **Film mode**

Enhanced picture quality is used to smooth out frame transitions while watching video. Film mode is only available for videos with a frame rate of 24fps.

G **Gain**

Adjust white temperature to customize your USER COLOR (can be saved in User Mode) or a specific color temperature and gain value (red, green, blue) use this setting.

Game mode

Integrating a gaming-oriented OSD design including pre-calibrated FPS, RTS and MOBA gaming settings, each mode is functionally customized with in-game testing and adjustments made for the best blend of color and technology.

Gamma

Allows users to manually adjust the brightness level of the monitor's grayscale levels. There are five selections: 1.8, 2.0, 2.2, 2.4, and 2.6.

H **HDR10 (High-Dynamic-Range)**

Reduces the overall contrast of a given scene so that detail in the highlights and shadows **can be seen**.*

*Only available on HDR 10 video content.

Hue

Adjusts the hue of each color (red, green, blue, cyan, magenta and yellow).

I **Information**

Displays the timing mode (video signal input) coming from the graphics card in the computer, the LCD model number, the serial number, and the ViewSonic® website URL. See your graphics card's user guide for instructions on changing the resolution and refresh rate (vertical frequency).

NOTE: VESA 1024 x 768 @ 60Hz (example) means that the resolution is 1024 x 768 and the refresh rate is 60 Hertz.

I Input select

Toggles between the various input options that are available for that particular monitor.

L Low input lag

ViewSonic offers low input lag, utilizing a monitor process reducer, which decreases signal latency. Under the low input lag submenu, you can select the appropriate speed for your desired use from the two options

M Manual image adjust

Displays the Manual Image Adjust menu. You can manually set a variety of image quality adjustments.

Memory recall

Returns the adjustments back to factory settings if the display is operating in a factory Preset Timing Mode listed in the Specifications of this manual.

* **Exception:** This control does not affect changes made with the Language Select or Power Lock setting

Multi-picture

Under MULTI-PICTURE MODE you can select the following settings, QUAD WINDOW, PBP TOP-BOTTOM, PBP LEFT-RIGHT, and PIP. The explanations for each setting are below.

1. QUAD WINDOWS: You can select four picture split screen type.
2. PBP TOP-BOTTOM: You can select two picture split screen types, and display two pictures side-by-sides on the top and bottom.
3. PBP LEFT-RIGHT: You can select 2 picture split screen types, and display 2 pictures side-by-side on the left and right.
4. PIP: Two picture split screen types, display large and the small pictures on the screen.
5. PIP SIZE: This controls the size of the sub-picture used in PIP.
6. PIP POSITION: This controls the position of sub-picture used in PIP mode.
7. PIP SWAP: This swaps the main-picture source and the sub-picture source.
8. SOURCE SELECT: This selects the source of the MULTI-PICTURE use in the QUAD WINDOW, PBP TOP-BOTTOM, PBP LEFT-RIGHT and PIP.

O Offset

Adjusts black levels for red, green and blue.

The gain and offset functions allow users to control the white balance for the upmost control when manipulating contrast and dark scenes.

OSD pivot

Set monitor OSD screen display direction.

Options	Explanation
Auto	With built-in G sensor, the OSD can auto pivot when positioned vertically.
0°	Set the OSD screen without pivot
+90°	Set the OSD screen +90° pivot
-90°	Set the OSD screen -90° pivot
180°	Set the OSD screen 180° pivot

Overscan

Refers to a cropped image on your monitor screen. A setting on your monitor zooms in on movie content, so that you can't see the outermost edges of the film.

P Preset color mode

Monitor comes with several display industry color standards. Each color mode can be selected for specific monitor application.

Options	Explanation
AdobeRGB	Precise color gamut and gamma of AdobeRGB (1998) standard
sRGB	Precise color gamut and gamma of sRGB standard
EBU	Precise color gamut and gamma of European Broadcasting Union standard
SMPTE-C	Precise color gamut and gamma of SMPTE-C standard
REC709	Precise color gamut and gamma of ITU-R Rec. 709 standard
DICOM SIM	Gamma curve are set to a DICOM simulation
Native	Original color presented by the LCD panel

R

Recall

Resets the Veivmode monitor settings.

Resolution notice

The notice tells users that the current viewing resolution is not the correct native resolution. This notice will appear in the display settings window, when setting up the display resolution.

Response time

Adjusts the response time, creating smooth images without streaking, blurring or ghosting. A low response time is perfect for the most graphic-intensive gaming, and provides amazing visual quality while watching sports or action movies.

S

Saturation

Adjusts the color depth of each color (red, green, blue, cyan, magenta and yellow)

Save as

The OSD save function is located in the main menu. There are 3 main positions (USER MODE 1, USER MODE 2, USER MODE3), which allows users to save their OSD settings.

Setup menu

Adjusts On-screen Display (OSD) settings. Many of these settings can activate on-screen display notifications so users do not have to reopen the menu.

Sharpness

Adjusts the sharpness and picture quality of the monitor.

S Standard color

Monitor comes with several display industry color standards. Each color mode can be selected for specific monitor application.

Options	Explanation
Adobe RGB	Precise color gamut and gamma of Adobe RGB standard.
sRGB	Precise color gamut and gamma of sRGB standard
EBU	Precise color gamut and gamma of European Broadcasting Union standard
SMPTE-C	Precise color gamut and gamma of SMPTE-C standard
DCI-P3	Precise color gamut and gamma of DCI-P3 standard.
REC709	Precise color gamut and gamma of ITU-R Rec. 709 standard
DICOM SIM	Gamma curve are set to a DICOM simulation
Native	Original color presented by the LCD panel
iPhone	Precise color gamut and gamma

U Uniformity

The Uniformity Correction function compensates any luminance and color uniformity imbalance on the screen, such as dark spots, uneven brightness, or illegible images on the screen. With the ViewSonic uniformity correction function, gray-scale levels become more balanced, and delta E scores are improved which increases reliability and provides the highest quality viewing experience from every monitor.

NOTE: If the uniformity function is enabled, it will reduce the overall peak luminance of the display.

V ViewMode

ViewSonic's unique ViewMode feature offers "Game," "Movie," "Web," "Text," and "Mono" presets. These presets are specifically designed to deliver an optimized viewing experience for different screen applications.

4-3. Advanced Settings Explanation

These settings have been explained in the OSD menu section above. Their functional use and instructions on setup are below.

1. Multi-Picture

Activate your OSD menu

Step 1: press the '1' on your ViewSonic Monitor bezel, to open the OSD (on screen display)

Step 2: Use the arrows to select the 'Manual Image Adjust' feature

Step 3: Use the arrow (buttons) to select the 'Multi-Picture' feature

Step 4: Next choose from the 'Multi-Picture' options-

Quad Windows
PBP Top-Bottom
PBP Left-Right
PIP

Step 5: After choosing your 'Multi-Picture' option, repeat steps 1 through 3 to go back to the 'Multi-Picture' options screen.

Step 6: Select the 'Source Select' option

Step 7: Choose the source you would like to display based on the chosen 'Multi-Picture' option

1-1. For Quad Windows-

Choose your source in the 'source select' sub-menu

Quad Window Options	Select an input option
Top-Left	
Top-Right	
Bottom-Left	
Bottom-Right	

1-2. For PBP Top-Bottom

Choose your source in the 'source select' sub-menu

PBP Options	Choose 1
Top Source	Mini DP
	DisplayPort
Bottom Source	HDMI 1
	HDMI 2
	Type C

In PBP Top-Bottom, please adjust the screen resolution to 3840x1080 in order to display full-sized main-picture and sub-pictyre image.

1-3. For PBP Left-Right

Choose your source in the 'source select' sub-menu

PBP Options	Choose 1
Left Source	Mini DP DisplayPort
Right Source	HDMI 1 HDMI 2 Type C

In PBP Left-Right, please adjust the screen resolution to 1920 x2160 in order to display full-sized main-picture and sub-picture image.

Main-picture Sub-picture

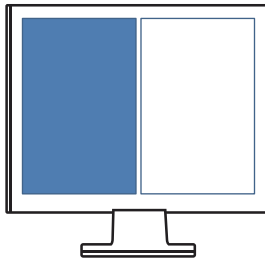

2. PIP

Under the PIP options choose which function you would like to adjust:

PIP Position
PIP Size
PIP Swap

2-1. PIP Position

Choose one to adjust the smaller screen's position:

PIP H. Position adjusts the horizontal position of the smaller screen on a range from 0-100, with 0 starting from the left position of the screen and 100 starting from the right position of the screen.

PIP V. Position adjusts the vertical position of the smaller screen on a range from 0-100, with 0 starting from the bottom side of the screen and 100 starting from the top side of the screen.

2-2. PIP Size

You can adjust the size of the smaller window by pressing the up and down arrows, with a range of 0-100

2-3. PIP Swap

Press PIP Swap to change the image source of the smaller screen with the larger screen when the PIP function is selected

To deactivate any "multi-picture" mode, simply go to the "multi-picture" option and select the same mode again to reset your monitor back to normal.

3. KVM function

KVM: Type- C KVM function is hardware device that allows user to control two PC's from one keyboard and mouse.(Only work on PBP mode)

Connect Setting

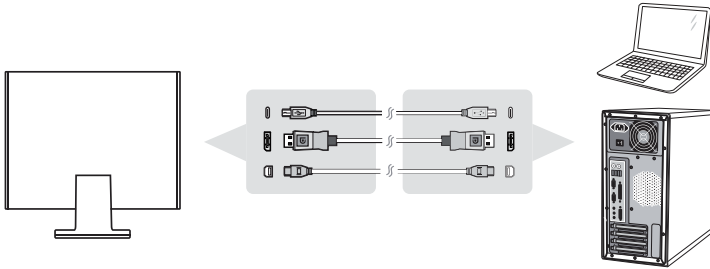

1. Connect one end of the Type C cable to the Type c connector on the rear of the monitor. And connect the other end of the Type C cable to the Type C connector on the MacBook, and so on
2. Connect one end of the DisplayPort cable to the DisplayPort or mini DP connector on the rear of the monitor. And connect the other end of the DisplayPort cable to the DisplayPort or mini DP connector on the computer.
3. Connect the Type-B end of the upstream cable to the Type-B port on the rear of the monitor and connect the Type-A end of the cable to the Type-A port on the computer.

OSD Setting for Type-C KVM

Step 1: Active your OSD

Step 2: Select the” Setup Menu”

Step 3: Select the “Multi-Picture “ menu

Step 4: Selcet the” PBP Left-Right “ menu

Short cuts key for KVM

In PBP mode, press and hold the # 1 key for 1 sec to activate the KVM function and switch the cursor between the main picture and the sub-picture.

Main-picture Sub-picture



Key Buttons

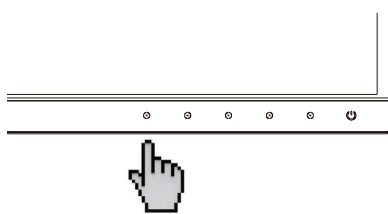

Main-picture Sub-picture

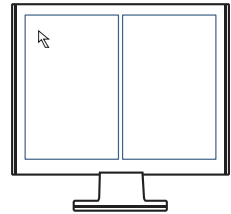

Dual Color: The monitor comes with a dual color engine to display two different color setting in PIP or PBP mode. You can set different color presets in both the main picture and the sub-picture.

Step 1: Active your OSD

Step 2: Select the " Setup Menu"

Step 3: Select the "Multi-Picture " menu

Step 4: Selcetet the" PBP Left-Right " menu or " PIP" menu

Step 5: Select the "Dual color"

Under the Dual Color sub menu choice which color you would like to display.

Main-picture Sub-picture

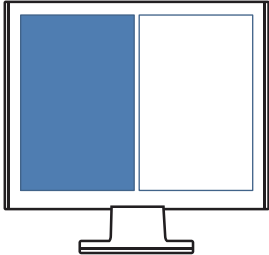

Dual color menu

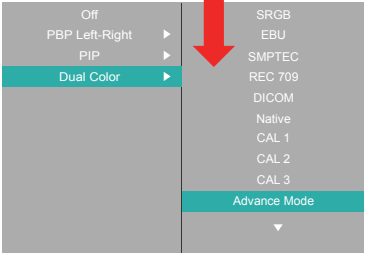

Ambient light sensor: Automatically adjusts the monitor’s brightness to the optimal settings based on the level of brightness in your environment.

Step 1: Active your OSD

Step 2: Select the "Setup Menu"

Step 3: Select the "Ambient light sensor" menu

In the Ambient Light Sensor sub-menu, you can use the following three option to adjust brightness.



Presence sensor: The human sensor prompts the monitor to switch to power saving mode (backlight off only) when you are absent for more than 15 sec and turns the backlight on again when you return after 3 sec.

Step 1: Active your OSD

Step 2: Select the "Setup Menu"

Step 3: Select the "Ambient light sensor" menu

Under the Presence Sensor sub-menu, you can select from three options to set the desired level.

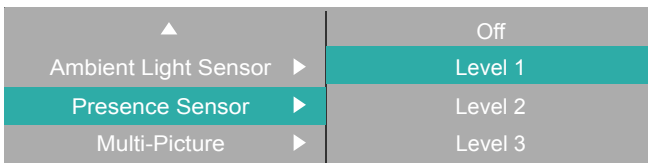



Presence Sensor & Ambient Light Sensor

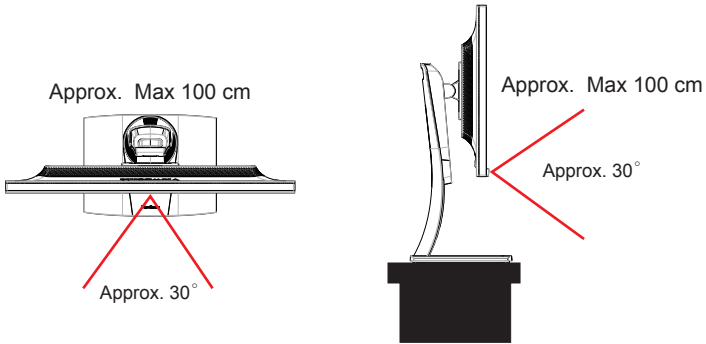

The Presence Sensor is capable of detecting movements vertically and horizontally. Interference with the Presence Sensor may occur if the monitor height is positioned under 16 cm.

Note: In order to avoid sensor interference, please remove any protective stickers from around the sensor

Blue light filter

Shortcuts key for Low Blue Light

Press the #5 key to immediately activate the Low Blue Light function (w/signal)

Key Buttons

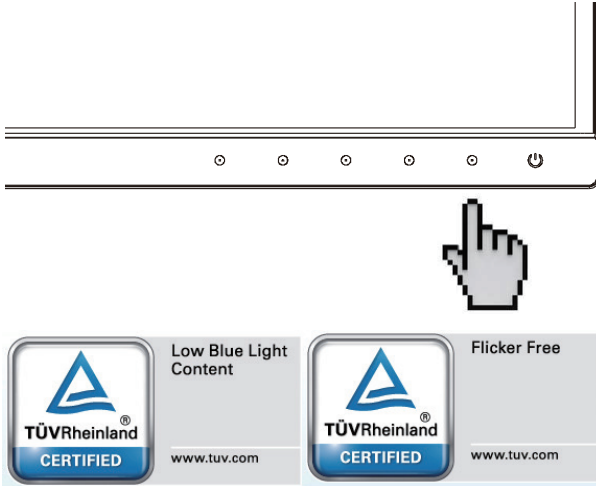

Note: Viewing computer screens for extended periods of time may cause eye irritation and discomfort. To reduce these effects, it is recommended to take periodic breaks from viewing to allow the eyes to relax.

Calculating Breaks

When viewing the monitor for extended periods, it is recommended to take periodic breaks from viewing. Short breaks of at least 5 minutes are recommended after 1 -2 hour of continuous viewing. Taking shorter, more frequent breaks are generally more beneficial than longer, less frequent breaks.

Looking at distance objects

While taking breaks, users can further reduce eye strain and dryness by focusing on objects that are further away from them.

- **Eye Exercises**

Eye exercises can help minimize eye strain. Slowly roll your eyes to the left, right, up, down and repeat as needed.

- **Neck Exercises**

Neck exercises can also help minimize eye strain. Relax your arms to let them hang at your sides, bend forward slightly to stretch the neck, turn your head to the right and to the left and repeat as needed.

4-4. Advanced Settings for Gamers

These settings have been explained in the OSD menu section above. Their functional use and instructions on setup are below.

1. Low Input Lag

Step 1: Activate your OSD

Step 2: Select the “Manual Image Adjust” menu

Step 3: Select the “Advanced Image Adjust” menu

Step 4: Select Low Input Lag

Under the low input lag submenu, you can select the appropriate speed for your desired use from the two options

Off
Advanced
Ultra Fast

If you would like turn the Low Input Lag function off, select “Off”

2. Black Stabilization

Step 1: Activate your OSD

Step 2: Select the “Manual Image Adjust” menu

Step 3: Select the “Advanced Image Adjust” menu

Step 4: Select “Black Stabilization”

You can adjust the setting by using the arrow buttons, selecting a number value from 1-10, with 1 being the darkest and 10 being the lightest selection setting.

4-5. Monitor Setting Management

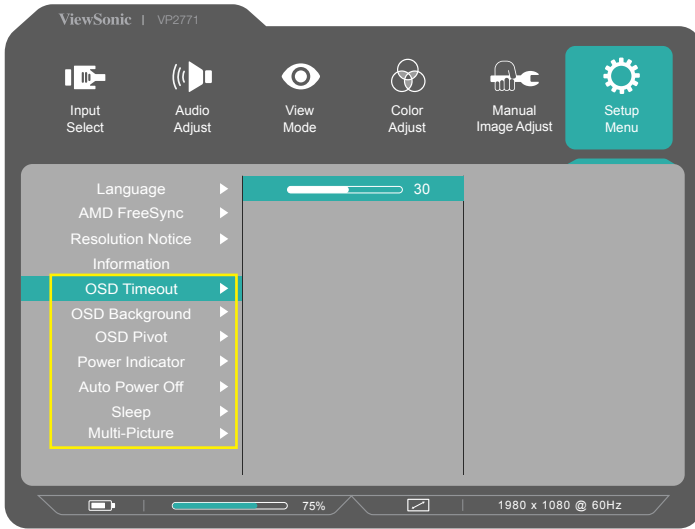

The monitor power management menu options are highlighted above. The explanation for each option is listed below.

OSD Timeout

The OSD Timeout function, allows users to choose how long the OSD will reside on the screen after in-activity (number of seconds).

OSD Background

The OSD Background function allows users to turn off the OSD background while selecting and adjusting OSD settings.

Power Indicator

The power indicator is the light that displays whether the monitor is on or off.

Auto Power Off

Selecting Auto Power Off, allows the monitor to shut its power off after a certain amount of time.

Sleep

This setting allows users to adjust the time of inactivity before the monitor goes on a reduced power mode. The screen will be on 'sleep mode' during this time.

Eco Mode

Allows users to choose between various modes, based on power consumption.

DDC/CI (Display Data Channel Command Interface)

Activating this setting allows monitor control via the graphics card.

5. Specifications

LCD	Type	TFT (Thin Film Transistor), Active Matrix 3840 x 2160 LCD, 0.1554mm x 0.1554mm pixel pitch
	Display Size	Metric: 68.47 cm Imperial: 27" (27" viewable)
	Color Filter	RGB vertical stripe
	Glass Surface	Anti-Glare

Input Signal	Video Sync	TMDS digital (100ohms) f_h :15-204 KHz, f_v :24-120 hz
---------------------	------------	---

Compatibility	PC	Up to 3840 x 2160 Non-interlaced
	Macintosh ¹	Power Macintosh up to 3840 x 2160 (Supported by limited graphic cards)

Resolution²	Recommended	3840 x 2160 @ 60 Hz
	Supported	3840 x 2160 @ 30 Hz 3840 x 1080 @ 60 Hz 2560 x 1440 @ 60 Hz 1920 x 2160 @ 60 Hz 1920 x 1080 @ 60 Hz 1680 x 1050 @ 60 Hz 1440 x 900 @ 60 Hz 1280 x 1440 @ 60 Hz 1280 x 1024 @ 60, 75 Hz 1024 x 768 @ 60, 70, 75 Hz 800 x 600 @ 56, 60, 72, 75 Hz 640 x 480 @ 60, 72, 75 Hz 720 x 400 @ 70 Hz

Power Adaptor³	Input Voltage	100-240 VAC, 50/60 Hz (auto switch)
	output voltage	19.5V, 9.23A
Display area	Full Scan	596.74 mm (H) x 335.66 mm (V) 23.49" (H) x 13.21" (V)
Operating conditions	Temperature	+32 °F to +104 °F (0 °C to +40 °C)
	Humidity	20% to 90% (non-condensing)
	Altitude	To 16404 feet
Storage conditions	Temperature	-4 °F to +140 °F (-20 °C to +60 °C)
	Humidity	5% to 90% (non-condensing)
	Altitude	To 40,000 feet
Dimensions	Physical	612.4 mm (W) x 545.51 mm (H) x 214.96 mm (D) 24.11" (W) x 21.48" (H) x 8.46" (D)
Wall Mount	Distance	100 x 100 mm
Weight	Physical	GF.€5 lb (J.Í 5 kg)
Power saving modes	On ⁴	63W (Typical) (Blue LED)
	Off	<0.3W

¹ Macintosh computers may require a ViewSonic® Macintosh adapter. To order an adapter, contact ViewSonic.

² Do not set the graphics card in your computer to exceed these timing mode; doing so may result in permanent damage to the display.

³ Please use the power adaptor from ViewSonic® or authorized source only.

⁴ The test condition follows EEl standard

6. Troubleshooting

No power

- Make sure the power button (or switch) is ON.
- Make sure the A/C power cord is securely connected to the display.
- Plug another electrical device (like a radio) into the power outlet to verify that the outlet is supplying proper voltage.

Power is ON but no screen image

- Make sure the video cable supplied with the display is properly secured to the video output port on the back of the computer. If the other end of the video cable is not attached permanently to the display, properly secure it to the display.
- Adjust brightness and contrast.
- If you are using an Macintosh older than G3, you need a Macintosh adapt

Wrong or abnormal colors

- If any colors (red, green, or blue) are missing, check the video cable to make sure it is securely connected. Loose or broken pins in the cable connector could cause an improper connection.
- Connect the display to another computer.
- If you have an older graphics card, contact ViewSonic® for a non-DDC adapter.

Control buttons do not work

- Press only one button at a time.

7. Cleaning and Maintenance

Safe Cleaning Practices

- Make sure the display is turned off.
- Never spray or pour any liquid directly onto the screen or case.

To clean the screen:

1. Wipe the screen with a clean, soft, lint-free cloth. This removes dust and other particles.
2. If the screen is still not clean, apply a small amount of non-ammonia, non-alcohol based glass cleaner onto a clean, soft, lint-free cloth, and wipe the screen.

To clean the case:

1. Use a soft, dry cloth.
2. If the case is still not clean, apply a small amount of a non-ammonia, non-alcohol based, mild non-abrasive detergent onto a clean, soft, lint-free cloth, then wipe the surface.

Disclaimer

- ViewSonic® does not recommend the use of any ammonia or alcohol-based cleaners on the display screen or case. Some chemical cleaners have been reported to damage the screen and/or case of the display.
- ViewSonic will not be liable for damage resulting from use of any ammonia or alcoholbased cleaners.

Caution:

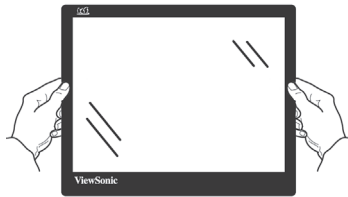

Handle the monitor on the edges only.

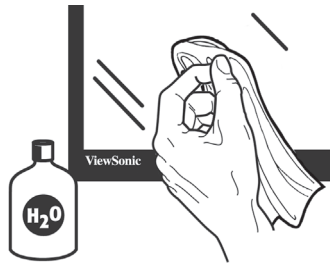

Clean with water on a soft cotton cloth only.

8. Compliance Information

NOTE: This section addresses all connected requirements and statements regarding regulations. Confirmed corresponding applications shall refer to nameplate labels and relevant markings on unit.

8-1. FCC Compliance Statement

This device complies with part 15 of FCC Rules. Operation is subject to the following two conditions: (1) this device may not cause harmful interference, and (2) this device must accept any interference received, including interference that may cause undesired operation.

This equipment has been tested and found to comply with the limits for a Class B digital device, pursuant to part 15 of the FCC Rules. These limits are designed to provide reasonable protection against harmful interference in a residential installation. This equipment generates, uses, and can radiate radio frequency energy, and if not installed and used in accordance with the instructions, may cause harmful interference to radio communications. However, there is no guarantee that interference will not occur in a particular installation. If this equipment does cause harmful interference to radio or television reception, which can be determined by turning the equipment off and on, the user is encouraged to try to correct the interference by one or more of the following measures:

- Reorient or relocate the receiving antenna.
- Increase the separation between the equipment and receiver.
- Connect the equipment into an outlet on a circuit different from that to which the receiver is connected.
- Consult the dealer or an experienced radio/TV technician for help.

Warning: You are cautioned that changes or modifications not expressly approved by the party responsible for compliance could void your authority to operate the equipment.

8-2. Industry Canada Statement

CAN ICES-3 (B)/NMB-3(B)

8-3. CE Conformity for European Countries

CE The device complies with the EMC Directive 2014/30/EU and Low Voltage Directive 2014/35/EU.

Following information is only for EU-member states:

The mark shown to the right is in compliance with the Waste Electrical and Electronic Equipment Directive 2012/19/EU (WEEE). The mark indicates the requirement NOT to dispose the equipment as unsorted municipal waste, but use the return and collection systems according to local law.



8-4. Declaration of RoHS2 Compliance

This product has been designed and manufactured in compliance with Directive 2011/65/EU of the European Parliament and the Council on restriction of the use of certain hazardous substances in electrical and electronic equipment (RoHS2 Directive) and is deemed to comply with the maximum concentration values issued by the European Technical Adaptation Committee (TAC) as shown below:

Substance	Proposed Maximum Concentration	Actual Concentration
Lead (Pb)	0.1%	< 0.1%
Mercury (Hg)	0.1%	< 0.1%
Cadmium (Cd)	0.01%	< 0.01%
Hexavalent Chromium (Cr ⁶⁺)	0.1%	< 0.1%
Polybrominated biphenyls (PBB)	0.1%	< 0.1%
Polybrominated diphenyl ethers (PBDE)	0.1%	< 0.1%

Certain components of products as stated above are exempted under the Annex III of the RoHS2 Directives as noted below:

Examples of exempted components are:

1. Mercury in cold cathode fluorescent lamps and external electrode fluorescent lamps (CCFL and EEFL) for special purposes not exceeding (per lamp):
 - (1) Short length (≤ 500 mm): maximum 3.5 mg per lamp.
 - (2) Medium length (> 500 mm and $\leq 1,500$ mm): maximum 5 mg per lamp.
 - (3) Long length ($> 1,500$ mm): maximum 13 mg per lamp.
2. Lead in glass of cathode ray tubes.
3. Lead in glass of fluorescent tubes not exceeding 0.2% by weight.
4. Lead as an alloying element in aluminium containing up to 0.4% lead by weight.
5. Copper alloy containing up to 4% lead by weight.
6. Lead in high melting temperature type solders (i.e. lead-based alloys containing 85% by weight or more lead).
7. Electrical and electronic components containing lead in a glass or ceramic other than dielectric ceramic in capacitors, e.g. piezo-electronic devices, or in a glass or ceramic matrix compound.

8-5. Indian Restriction of Hazardous Substances

Restriction on Hazardous Substances statement (India) This product complies with the “India E-waste Rule 2011” and prohibits use of lead, mercury, hexavalent chromium, polybrominated biphenyls or polybrominated diphenyl ethers in concentrations exceeding 0.1 weight % and 0.01 weight % for cadmium, except for the exemptions set in Schedule 2 of the Rule.

8-6. Product Disposal at End of Product Life

ViewSonic respects the environment and is committed to working and living green. Thank you for being part of Smarter, Greener Computing.

Please visit ViewSonic website to learn more.

USA & Canada:

<http://www.viewsonic.com/company/green/recycle-program/>

Europe:

<http://www.viewsoniceurope.com/uk/support/recycling-information/>

Taiwan: <http://recycle.epa.gov.tw/recycle/index2.aspx>

9. Copyright Information

Copyright ©ViewSonic® Corporation, 2017. All rights reserved.

Macintosh and Power Macintosh are registered trademarks of Apple Inc.

Microsoft, Windows, and the Windows logo are registered trademarks of Microsoft Corporation in the United States and other countries.

ViewSonic, the three birds logo, OnView, ViewMatch, and ViewMeter are registered trademarks of ViewSonic Corporation.

VESA is a registered trademark of the Video Electronics Standards Association. DPMS, DisplayPort, and DDC are trademarks of VESA.

ENERGY STAR® is a registered trademark of the U.S. Environmental Protection Agency (EPA).

As an ENERGY STAR® partner, ViewSonic Corporation has determined that this product meets the ENERGY STAR® guidelines for energy efficiency.

Disclaimer: ViewSonic Corporation shall not be liable for technical or editorial errors or omissions contained herein; nor for incidental or consequential damages resulting from furnishing this material, or the performance or use of this product.

In the interest of continuing product improvement, ViewSonic Corporation reserves the right to change product specifications without notice. Information in this document may change without notice.

No part of this document may be copied, reproduced, or transmitted by any means, for any purpose without prior written permission from ViewSonic Corporation.

10. Service Information

Product Registration

Thank you for purchasing a ViewSonic product! Registering activates your product's standard Limited Warranty and entitles you to receive new product updates and information if desired.

Please complete this form to register your new product, then mail/fax to ViewSonic using the information provided on the following page. Items marked with an asterisk (*) are required.

First Name* (given name) _____

Last Name* (family name) _____

Email Address* _____

Street Address* (line 1) _____

Street Address* (line 2) _____

City/Country* _____ State/Province* _____

Zip code/Postal code* _____ Country* _____

Phone Number* _____ Date Purchased* _____

Product Type* _____ Model Number* _____

Serial Number* _____

Operating System _____

YES NO | Check "YES" to receive email communication from ViewSonic, including exclusive promotional offers.

At ViewSonic we respect your privacy. ViewSonic does not sell its customer lists or similar information to third parties.

*Product registration available in selected countries only



Customer Service

For technical support or product service, see the table below or contact your reseller.

NOTE: You will need the product serial number.

Asia pacific			
Country/ Region	Website	T= Telephone C = CHAT ONLINE	Email
ViewSonic Corporation	http://www.viewsonic.com.tw/	T= 886 2 2246 3456 F= 886 2 2249 1751 Toll Free= 0800-899880	service@tw.viewsonic.com
China	www.viewsonic.com.cn	T= 4008 988 588	service.cn@cn.viewsonic.com
Hong Kong	www.hk.viewsonic.com	T= 852 3102 2900	service@hk.viewsonic.com
Macau	www.hk.viewsonic.com	T= 853 2840 3687	service@hk.viewsonic.com
Japan	www.viewsonicjapan.co.jp	T= 0120 341 329	service@jp.viewsonic.com
Korea	ap.viewsonic.com/kr/	T= 080 333 2131	service@kr.viewsonic.com
India	www.in.viewsonic.com	T= 1800 419 0959	service@in.viewsonic.com
Singapore/ Malaysia/ Thailand	www.ap.viewsonic.com	T= 65 6461 6044	service@sg.viewsonic.com
Europe			
Europe	www.viewsoniceurope.com	http://www.viewsoniceurope.com/eu/support/call-desk/	
Arabia	ap.viewsonic.com/me/		اتصل بالبايع المحلي
България	www.viewsoinceurope.com	http://www.viewsoniceurope.com/eu/support/call-desk/	service_bg@viewsoniceurope.com
Hrvatska	www.viewsoinceurope.com	http://www.viewsoniceurope.com/eu/support/call-desk/	service_hr@viewsoniceurope.com
Česká Republika	www.viewsoniceurope.com	http://www.viewsoniceurope.com/eu/support/call-desk/	service_cz@viewsoniceurope.com
Nederland	www.viewsoniceurope.com	http://www.viewsoniceurope.com/eu/support/call-desk/	service_nl@viewsoniceurope.com
Suomi	www.viewsoniceurope.com	http://www.viewsoniceurope.com/eu/support/call-desk/	service_fi@viewsoniceurope.com
France et autres pays francophones en Europe	www.viewsoniceurope.com/fr/	www.viewsoniceurope.com/fr/support/call-desk/	service_fr@viewsoniceurope.com
Canada	www.viewsonic.com	T (Numéro vert)= 1-866-463-4775	service.ca@viewsonic.com

Suisse	www.viewsoniceurope.com/de/	www.viewsoniceurope.com/de/support/call-desk/	service_ch@viewsoniceurope.com
Belgique (Français)	www.viewsoniceurope.com/fr/	www.viewsoniceurope.com/fr/support/call-desk/	service_be@viewsoniceurope.com
Luxembourg (Français)	www.viewsoniceurope.com/fr/	www.viewsoniceurope.com/fr/support/call-desk/	service_lu@viewsoniceurope.com
Deutschland	www.viewsoniceurope.com/de/	www.viewsoniceurope.com/de/support/call-desk/	service_deu@viewsoniceurope.com
Österreich	www.viewsoniceurope.com/de/	www.viewsoniceurope.com/de/support/call-desk/	service_at@viewsoniceurope.com
Schweiz (Deutsch)	www.viewsoniceurope.com/de/	www.viewsoniceurope.com/de/support/call-desk/	service_ch@viewsoniceurope.com
Ελλάδα	www.viewsoniceurope.com	http://www.viewsoniceurope.com/eu/support/call-desk/	service_gr@viewsoniceurope.com
Magyar Köztársaság	www.viewsoniceurope.com	http://www.viewsoniceurope.com/eu/support/call-desk/	service_hu@viewsoniceurope.com
Italia e altri paesi di lingua italiana in Europa	www.viewsoniceurope.com	http://www.viewsoniceurope.com/eu/support/call-desk/	service_it@viewsoniceurope.com
Spain	www.viewsoniceurope.com/es/	www.viewsoniceurope.com/es/support/call-desk/	service_es@viewsoniceurope.com
Latinoamérica (México)	www.viewsonic.com/la/	T= 001-8882328722	soporte@viewsonic.com
Italia e altri paesi di lingua italiana in Europa	www.viewsoniceurope.com	http://www.viewsoniceurope.com/eu/support/call-desk/	service_it@viewsoniceurope.com
Polska i inne kraje Europy Centralnej	www.viewsoniceurope.com	http://www.viewsoniceurope.com/eu/support/call-desk/	service_pl@viewsoniceurope.com
Portugal	www.viewsoniceurope.com	http://www.viewsoniceurope.com/eu/support/call-desk/	service_pt@viewsoniceurope.com
România	www.viewsoinceurope.com	http://www.viewsoniceurope.com/eu/support/call-desk/	service_ro@viewsoniceurope.com
Россия	www.viewsoniceurope.com/ru/	www.viewsoniceurope.com/ru/support/call-desk/	service_ru@viewsoniceurope.com
Беларусь (Русский)	www.viewsoniceurope.com/ru/	www.viewsoniceurope.com/ru/support/call-desk/	service_br@viewsoniceurope.com
Латвия (Русский)	www.viewsoniceurope.com/ru/	www.viewsoniceurope.com/ru/support/call-desk/	service_lv@viewsoniceurope.com
Srbija	www.viewsoniceurope.com	http://www.viewsoniceurope.com/eu/support/call-desk/	service_rs@viewsoniceurope.com
Slovensko	www.viewsoinceurope.com	http://www.viewsoniceurope.com/eu/support/call-desk/	service_sk@viewsoniceurope.com
Slovenija	www.viewsoinceurope.com	http://www.viewsoniceurope.com/eu/support/call-desk/	service_si@viewsoniceurope.com
Sverige	www.viewsoniceurope.com	http://www.viewsoniceurope.com/eu/support/call-desk/	service_se@viewsoniceurope.com

Türkiye	http://www.viewsoniceurope.com/tr/	www.viewsoniceurope.com/tr/support/call-desk/	service_tr@viewsoniceurope.com
Україна	www.viewsoniceurope.com	http://www.viewsoniceurope.com/eu/support/call-desk/	service_ua@viewsoniceurope.com
America			
Australia New Zealand	www.viewsonic.com.au	AUS= 1800 880 818 NZ= 0800 008 822	service@au.viewsonic.com
Canada	www.viewsonic.com	T= 1-866-463-4775	service.ca@viewsonic.com
Latin America (Argentina)	www.viewsonic.com/la/	C= http://www.viewsonic.com/la/soporte/servicio-tecnico	soporte@viewsonic.com
Latin America (Chile)	www.viewsonic.com/la/	C= http://www.viewsonic.com/la/soporte/servicio-tecnico	soporte@viewsonic.com
Latin America (Columbia)	www.viewsonic.com/la/	C= http://www.viewsonic.com/la/soporte/servicio-tecnico	soporte@viewsonic.com
Latin America (Mexico)	www.viewsonic.com/la/	C= http://www.viewsonic.com/la/soporte/servicio-tecnico	soporte@viewsonic.com
Nexus Hightech Solutions, Cincinnati #40 Desp. 1 Col. De los Deportes Mexico D.F. Tel: 55) 6547-6454 55)6547-6484 Other places please refer to http://www.viewsonic.com/la/soporte/servicio-tecnico#mexico			
Latin America (Peru)	www.viewsonic.com/la/	C= http://www.viewsonic.com/la/soporte/servicio-tecnico	soporte@viewsonic.com
Middle East	ap.viewsonic.com/me/	Contact your reseller	service@ap.viewsonic.com
Puerto Rico & Virgin Islands	www.viewsonic.com	T= 1-800-688-6688 (English) C= http://www.viewsonic.com/la/soporte/servicio-tecnico	service.us@viewsonic.com soporte@viewsonic.com
South Africa	ap.viewsonic.com/za/	Contact your reseller	service@ap.viewsonic.com
United States	www.viewsonic.com	T= 1-800-688-6688	service.us@viewsonic.com

Limited Warranty

ViewSonic® Display

What the warranty covers:

ViewSonic warrants its products to be free from defects in material and workmanship during the warranty period. If a product proves to be defective in material or workmanship during the warranty period, ViewSonic will, at its sole option, and as your sole remedy, repair or replace the product with a similar product. Replacement Product or parts may include remanufactured or refurbished parts or components. The repair or replacement unit or parts or components will be covered by the balance of the time remaining on the customer's original limited warranty and the warranty period will not be extended. ViewSonic provides no warranty for any third-party software whether included with the product or installed by the customer, installation of any unauthorized hardware parts or components (e.g. Projector Lamps). (Please refer to: "What the warranty does not cover" section)

How long the warranty is effective:

ViewSonic displays are warranted for between 1 and 3 years, depending on your country of purchase, for all parts including the light source and for all labour from the date of the first consumer purchase

Who the warranty protects:

This warranty is valid only for the first consumer purchaser.

What the warranty excludes and does not cover:

Any product on which the serial number has been defaced, modified or removed.

Damage, deterioration or malfunction resulting from:

1. Accident, misuse, neglect, fire, water, lightning, or other acts of nature, unauthorized product modification, or failure to follow instructions supplied with the product.
2. Repair or attempted repair by anyone not authorized by ViewSonic.
3. Damage to or loss of any programs, data or removable storage media.
4. Software or data loss occurring during repair or replacement.
5. Any damage of the product due to shipment.
6. Removal or installation of the product.
7. Causes external to the product, such as electric power fluctuations or failure.
8. Use of supplies or parts not meeting ViewSonic's specifications.
9. Normal wear and tear.
10. Failure of owner to perform periodic product maintenance as stated in User Guide, such as cleaning of user-cleanable projector filters.
11. Any other cause which does not relate to a product defect.
12. Damage caused by static (non-moving) images displayed for lengthy periods of time (also referred to as image burn-in).
13. Software - Any third-party software included with the product or installed by the customer.

14. Hardware/Accessories/Parts/Components - Installation of any unauthorized hardware, accessories, consumable parts or components (e.g. Projector Lamps).
15. Damage to, or abuse of, the coating on the surface of the display through inappropriate cleaning as described in product User Guide.
16. Removal, installation, and set-up service charges, including wall-mounting of product.

How to get service:

1. For information about receiving service under warranty, contact ViewSonic Customer Support (Please refer to Customer Support page). You will need to provide your product's serial number.
2. To obtain warranty service, you will be required to provide (a) the original dated sales slip, (b) your name, (c) your address, (d) a description of the problem, and (e) the serial number of the product.
3. Take or ship the product freight prepaid in the original container to an authorized ViewSonic service center or ViewSonic.
4. For additional information or the name of the nearest ViewSonic service center, contact ViewSonic.

Limitation of implied warranties:

There are no warranties, express or implied, which extend beyond the description contained herein including the implied warranty of merchantability and fitness for a particular purpose.

Exclusion of damages:

ViewSonic's liability is limited to the cost of repair or replacement of the product. ViewSonic shall not be liable for:

1. Damage to other property caused by any defects in the product, damages based upon inconvenience, loss of use of the product, loss of time, loss of profits, loss of business opportunity, loss of goodwill, interference with business relationships, or other commercial loss, even if advised of the possibility of such damages.
2. Any other damages, whether incidental, consequential or otherwise.
3. Any claim against the customer by any other party.
4. Repair or attempted repair by anyone not authorized by ViewSonic.

Effect of state law:

This warranty gives you specific legal rights, and you may also have other rights which vary from state to state. Some states do not allow limitations on implied warranties and/or do not allow the exclusion of incidental or consequential damages, so the above limitations and exclusions may not apply to you.

Sales outside the U.S.A. and Canada:

For warranty information and service on ViewSonic products sold outside of the U.S.A. and Canada, contact ViewSonic or your local ViewSonic dealer.

The warranty period for this product in mainland China (Hong Kong, Macao and Taiwan Excluded) is subject to the terms and conditions of the Maintenance Guarantee Card.

For users in Europe and Russia, full details of warranty provided can be found in www.viewsoniceurope.com under Support/Warranty Information.

Mexico Limited Warranty

ViewSonic® Display

What the warranty covers:

ViewSonic warrants its products to be free from defects in material and workmanship, under normal use, during the warranty period. If a product proves to be defective in material or workmanship during the warranty period, ViewSonic will, at its sole option, repair or replace the product with a like product. Replacement product or parts may include remanufactured or refurbished parts or components & accessories.

How long the warranty is effective:

ViewSonic LCD displays are warranted for between 1 and 3 years, depending on your country of purchase, for all parts including the light source and for all labour from the date of the first consumer purchase

Who the warranty protects:

This warranty is valid only for the first consumer purchaser.

What the warranty does not cover:

1. Any product on which the serial number has been defaced, modified or removed.
2. Damage, deterioration or malfunction resulting from:
 - a. Accident, misuse, neglect, fire, water, lightning, or other acts of nature, unauthorized product modification, unauthorized attempted repair, or failure to follow instructions supplied with the product.
 - b. Causes external to the product, such as electrical power fluctuations or failure.
 - c. Use of supplies or parts not meeting ViewSonic's specifications.
 - d. Normal wear and tear.
 - e. Any other cause which does not relate to a product defect.
3. Any product exhibiting a condition commonly known as "image burn-in" which results when a static image is displayed on the product for an extended period of time.
4. Removal, installation, insurance, and set-up service charges.

How to get service:

For information about receiving service under warranty, contact ViewSonic Customer Support (Please refer to the attached Customer Support page). You will need to provide your product's serial number, so please record the product information in the space provided below on your purchase for your future use. Please retain your receipt of proof of purchase to support your warranty claim.

For Your Records

Product Name: _____ Model Number: _____

Document Number: _____ Serial Number: _____

Purchase Date: _____ Extended Warranty Purchase? __ (Y/N)

If so, what date does warranty expire? _____

1. To obtain warranty service, you will be required to provide (a) the original dated sales slip, (b) your name, (c) your address, (d) a description of the problem, and (e) the serial number of the product.
2. Take or ship the product in the original container packaging to an authorized ViewSonic service center.
3. Round trip transportation costs for in-warranty products will be paid by ViewSonic.

Limitation of implied warranties:

There are no warranties, express or implied, which extend beyond the description contained herein including the implied warranty of merchantability and fitness for a particular purpose.

Exclusion of damages:

ViewSonic's liability is limited to the cost of repair or replacement of the product. ViewSonic shall not be liable for:

1. Damage to other property caused by any defects in the product, damages based upon inconvenience, loss of use of the product, loss of time, loss of profits, loss of business opportunity, loss of goodwill, interference with business relationships, or other commercial loss, even if advised of the possibility of such damages.
2. Any other damages, whether incidental, consequential or otherwise.
3. Any claim against the customer by any other party.
4. Repair or attempted repair by anyone not authorized by ViewSonic.

Contact Information for Sales & Authorized Service (Centro Autorizado de Servicio) within Mexico:	
Name, address, of manufacturer and importers: México, Av. de la Palma #8 Piso 2 Despacho 203, Corporativo Interpalmas, Col. San Fernando Huixquilucan, Estado de México Tel: (55) 3605-1099 http://www.viewsonic.com/la/soporte/index.htm	
NÚMERO GRATIS DE ASISTENCIA TÉCNICA PARA TODO MÉXICO: 001.866.823.2004	
Hermosillo: Distribuciones y Servicios Computacionales SA de CV. Calle Juarez 284 local 2 Col. Bugambilias C.P: 83140 Tel: 01-66-22-14-9005 E-Mail: disc2@hmo.megared.net.mx	Villahermosa: Compumantenimietnos Garantizados, S.A. de C.V. AV. GREGORIO MENDEZ #1504 COL, FLORIDA C.P. 86040 Tel: 01 (993) 3 52 00 47 / 3522074 / 3 52 20 09 E-Mail: compumantenimientos@prodigy.net.mx
Puebla, Pue. (Matriz): RENTA Y DATOS, S.A. DE C.V. Domicilio: 29 SUR 721 COL. LA PAZ 72160 PUEBLA, PUE. Tel: 01(52).222.891.55.77 CON 10 LINEAS E-Mail: datos@puebla.megared.net.mx	Veracruz, Ver.: CONEXION Y DESARROLLO, S.A DE C.V. Av. Americas # 419 ENTRE PINZÓN Y ALVARADO Fracc. Reforma C.P. 91919 Tel: 01-22-91-00-31-67 E-Mail: gacosta@qplus.com.mx
Chihuahua Soluciones Globales en Computación C. Magisterio # 3321 Col. Magisterial Chihuahua, Chih. Tel: 4136954 E-Mail: Cefeo@soluglobales.com	Cuernavaca Compusupport de Cuernavaca SA de CV Francisco Leyva # 178 Col. Miguel Hidalgo C.P. 62040, Cuernavaca Morelos Tel: 01 777 3180579 / 01 777 3124014 E-Mail: aquevedo@compusupportcva.com
Distrito Federal: QPLUS, S.A. de C.V. Av. Coyoacán 931 Col. Del Valle 03100, México, D.F. Tel: 01(52)55-50-00-27-35 E-Mail : gacosta@qplus.com.mx	Guadalajara, Jal.: SERVICRECE, S.A. de C.V. Av. Niños Héroes # 2281 Col. Arcos Sur, Sector Juárez 44170, Guadalajara, Jalisco Tel: 01(52)33-36-15-15-43 E-Mail: mmiranda@servicrece.com
Guerrero Acapulco GS Computación (Grupo Sesicomp) Progreso #6-A, Colo Centro 39300 Acapulco, Guerrero Tel: 744-48-32627	Monterrey: Global Product Services Mar Caribe # 1987, Esquina con Golfo Pérsico Fracc. Bernardo Reyes, CP 64280 Monterrey N.L. México Tel: 8129-5103 E-Mail: aydeem@gps1.com.mx
MERIDA: ELECTROSER Av Reforma No. 403Gx39 y 41 Mérida, Yucatán, México CP97000 Tel: (52) 999-925-1916 E-Mail: rrrb@sureste.com	Oaxaca, Oax.: CENTRO DE DISTRIBUCION Y SERVICIO, S.A. de C.V. Murguía # 708 P.A., Col. Centro, 68000, Oaxaca Tel: 01(52)95-15-15-22-22 Fax: 01(52)95-15-13-67-00 E-Mail: gpotai2001@hotmail.com
Tijuana: STD Av Ferrocarril Sonora #3780 L-C Col 20 de Noviembre Tijuana, Mexico	FOR USA SUPPORT: ViewSonic Corporation 381 Brea Canyon Road, Walnut, CA. 91789 USA Tel: 800-688-6688 (English); 866-323-8056 (Spanish); E-Mail: http://www.viewsonic.com

LCD Mexico Warranty Term Template In UG

VSC_TEMP_2008



ViewSonic®