

FOMEI
PHOTO

Photo Matt 230



© lunamarina - Fotolia.com

Photo Matt 230

portrait deep matte paper 230 g/m²

ICC profily a návody /
ICC profiles & guides:

 fomei.com/profily/
fomei.com/profiles

Kompatibilní tiskárny /
Compatible printers:

Canon

EPSON®



Hluboce matný portrétní papír s přirozeným podáním černé a vysokou ostrostí.

Určení: portrétní a výtvarná fotografie, fotoobrazy bez odlesků

Deep matte portrait paper with natural black and high sharpness.

Usage: portrait and art photography, photos without reflections

parametr / parameter	hodnota / value	standard / norm
gramáž / grammage	230 g/m ²	ISO 536
tloušťka / thickness	267 μm	ISO 534
bělost / whiteness	> 140 %	CIE, D65/2°
opacita (neprůhlednost) / opacity	> 95 %	ISO 2471

Manipulace s papírem / Paper handling:



18-25 °C



40-60 %

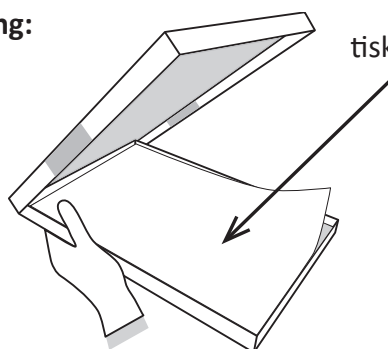













tisková strana / printing side



rukavice / gloves

 **FOMEI**

	FOMEI PHOTO Photo papers for home and professional Canon, EPSON, HP printers	available sheets - format [cm]										available rolls - width [cm]						
		9x13	10x15	13x18	A5	15x23	A4	A3	A3+*	A2	A2+*	43,2	61,0	91,4	106,7	111,8	127,0	152,4
	Archival Gloss 265 archival glossy RC paper 265 g/m ²	●	●	●	●	●	●	●	●	●	●	●	●	●	●	●	●	●
	Archival Velvet 265 archival semiglossy RC paper 265 g/m ²	●	●	●	●	●	●	●	●	●	●	●	●	●	●	●	●	●
	Metallic Gloss 255 high metallic glossy RC 255 g/m ²	●	●	●	●	●	●	●	●	●	●	●	●	●	●	●	●	●
	PRO Gloss 300 premium glossy PE paper 300 g/m ²	●	●	●	●	●	●	●	●	●	●	●	●	●	●	●	●	●
	PRO Pearl 300 premium semiglossy PE paper 300 g/m ²	●	●	●	●	●	●	●	●	●	●	●	●	●	●	●	●	●
	PRO Gloss 265 glossy RC paper 265 g/m ²	●	●	●	●	●	●	●	●	●	●	●	●	●	●	●	●	●
	PRO Pearl 265 semiglossy RC paper 265 g/m ²	●	●	●	●	●	●	●	●	●	●	●	●	●	●	●	●	●
	PRO Gloss 205 glossy RC paper 205 g/m ²	●	●	●	●	●	●	●	●	●	●	●	●	●	●	●	●	●
	PRO Pearl 205 semiglossy RC paper 205 g/m ²	●	●	●	●	●	●	●	●	●	●	●	●	●	●	●	●	●
	Photo Matt 230 portrait deep matte paper 230 g/m ²																	
	Premium Lustre 170 semiglossy poster & photo paper 170 g/m ²	●																
	Premium Matt 180 graphic matte paper 180 g/m ²																	