



Booklet available in English on
Heft in deutscher Sprache erhältlich auf
Livret disponible en français sur
Libretto disponibile in italiano su
Folleto en español disponible en
如需中文版手册, 请访问



[LEGO.com/sustainable-packaging](https://www.lego.com/sustainable-packaging)

DISPLAY YOUR WAY



Display your reconfigurable model as a table centrepiece or use the two mounting brackets to hang it on your wall.



Combine two sets to create a four-spoked centrepiece, or three sets for a large six-spoke centrepiece (for table decoration only).



DISCLAIMER: The mounting brackets can support one set. Combined sets should not be mounted on walls.



EVERLASTING CREATIVITY

🌿 Florists, interior designers and flower enthusiasts everywhere love getting creative with dried flowers. From delicate grasses to majestic petals, dried foliage makes such versatile décor for centrepieces, vase arrangements and wall art that can last for months, even years. With this latest addition to our LEGO® Botanical Collection, we hope you will feel inspired to turn your own 'LEGO everlastings' into a lush centrepiece in warm autumn colours.

Enjoy building!



CHRIS McVEIGH
Designer at the LEGO Group

PLANTS FROM PLANTS

»»» 'Fresh flowers are nature's gifts. There is so much beauty in preserving them, giving them lasting life, and celebrating them as works of art. But did you know that your LEGO® dried flower art also has elements made from plant-based plastic?'

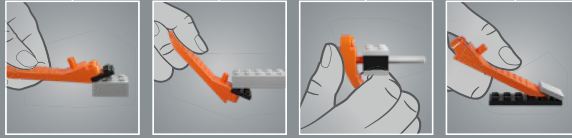
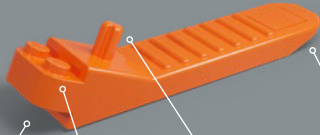

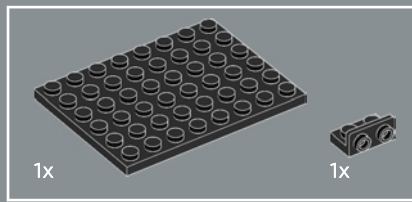

1

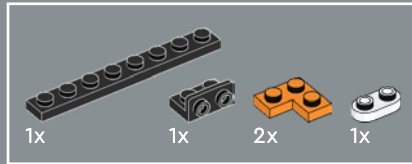
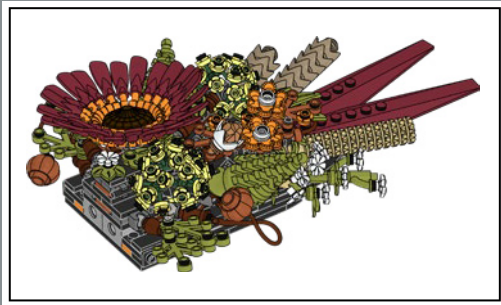
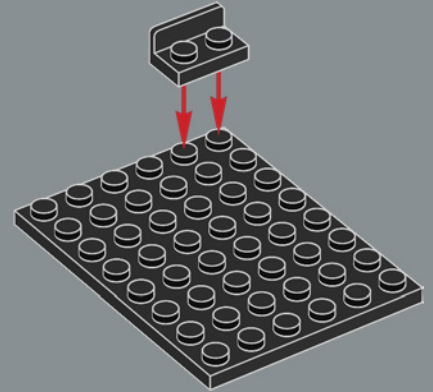

2

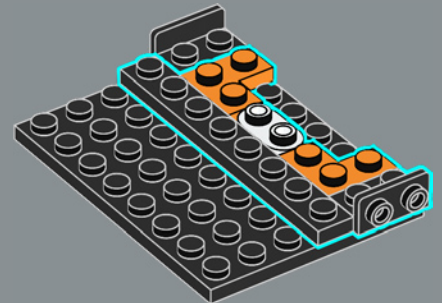

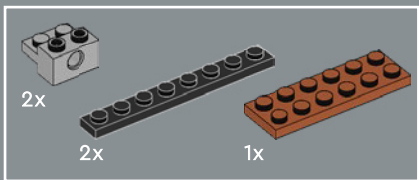

3

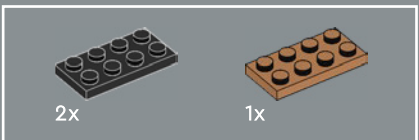
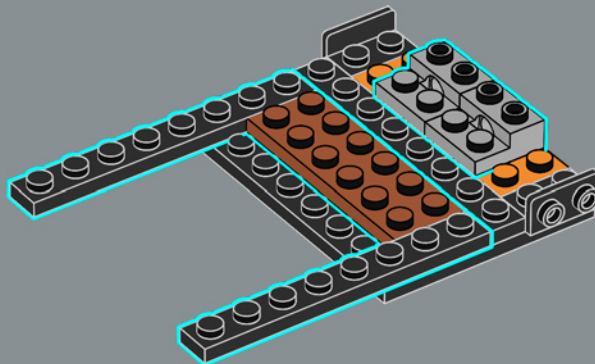

4

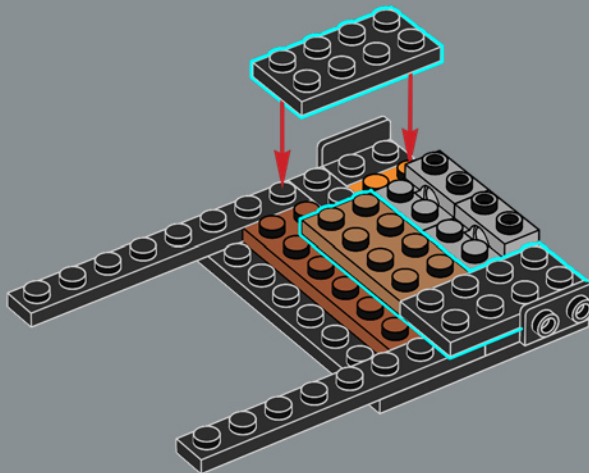

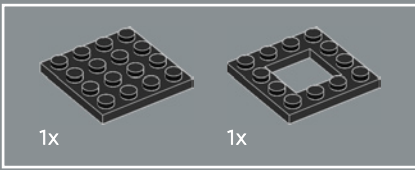

5

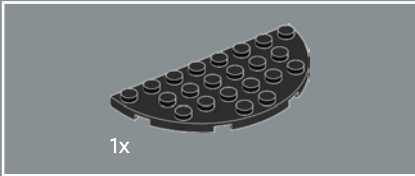
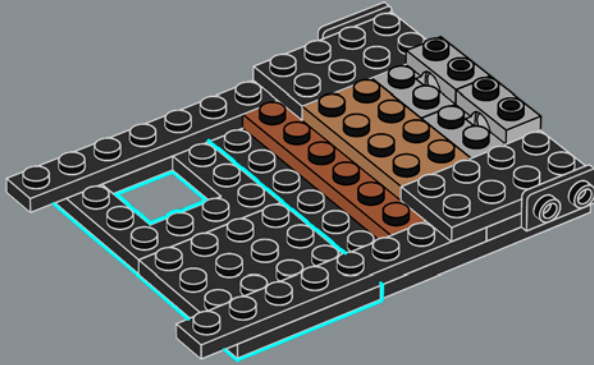

6

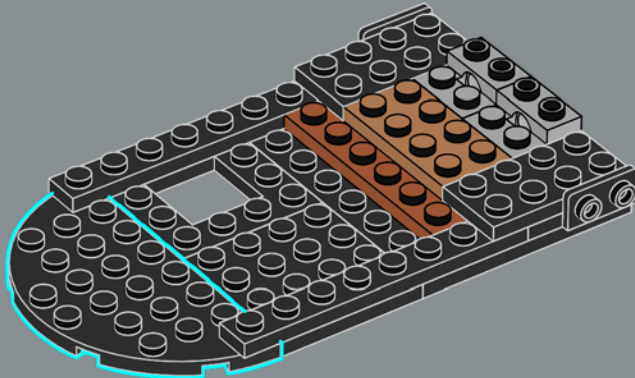

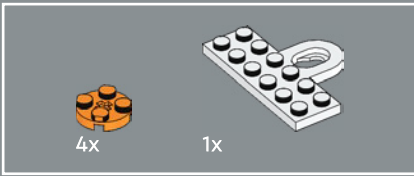

7



Built into each side of the model is a 2×6 plate with a mounting bracket so you can hang your decoration on a wall. This special element first appears in DOTS products.

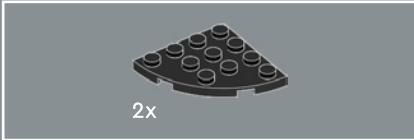
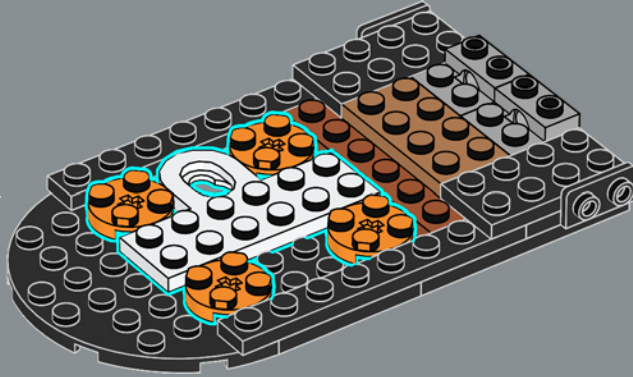

8

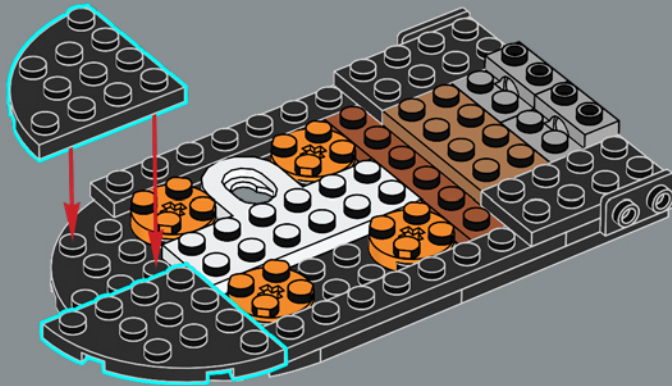

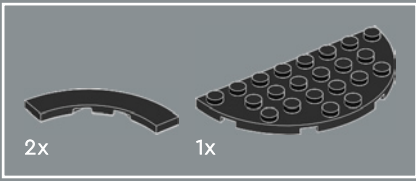

11

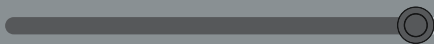
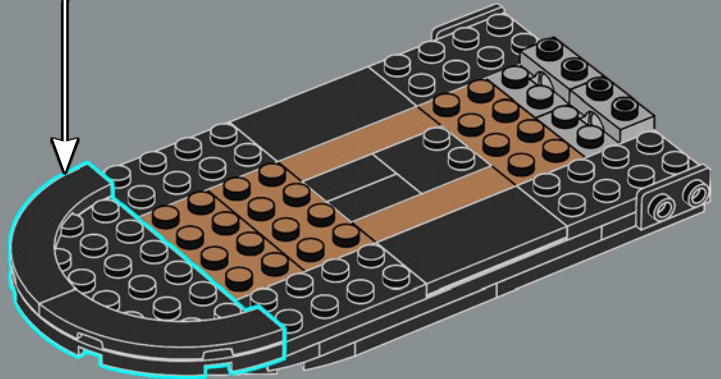
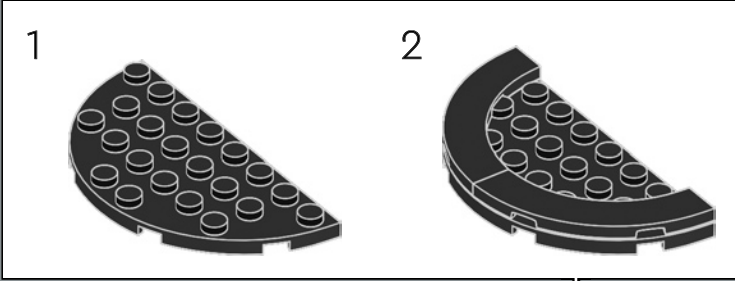

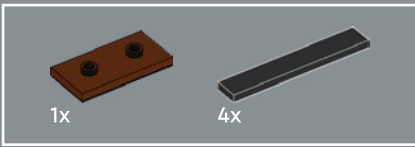

12

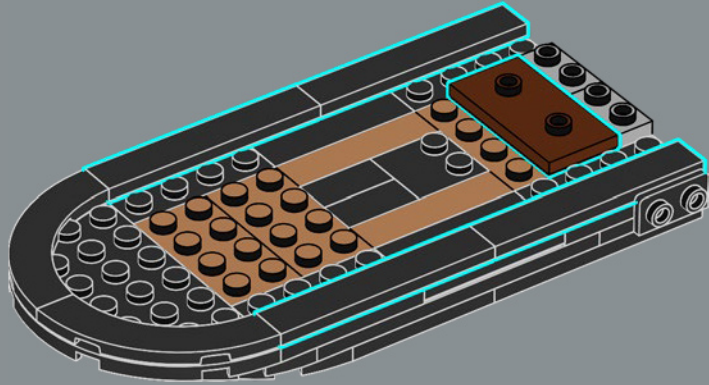

13

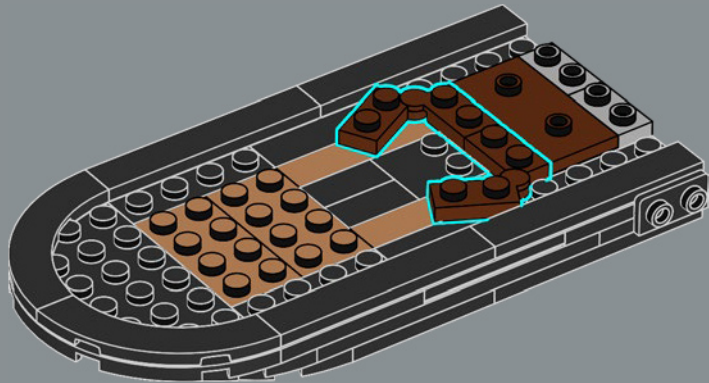

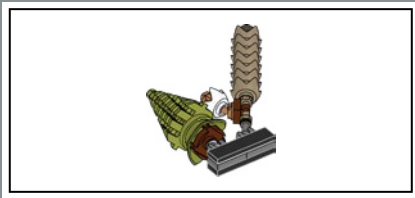

16

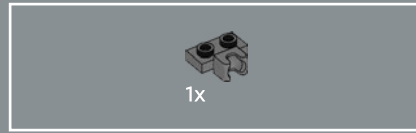
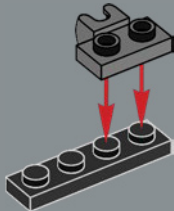

17

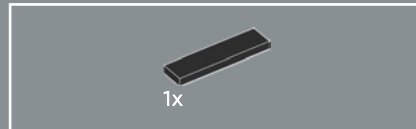
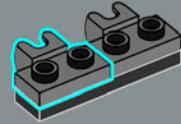

18

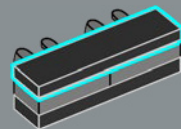



19

1



2



3

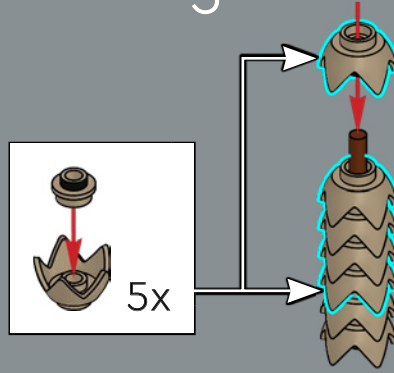

4





5

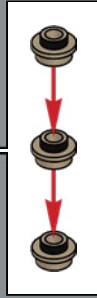

1x



1x



1x



1x

20

1



2



3

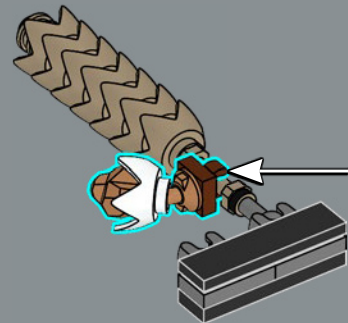
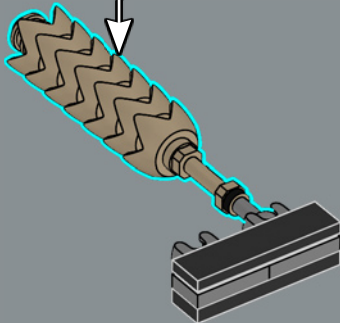

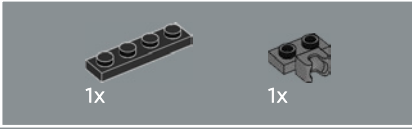
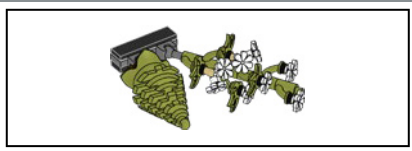

23

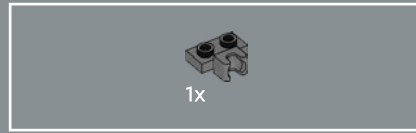
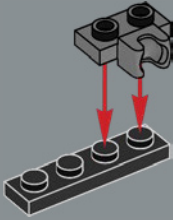

24

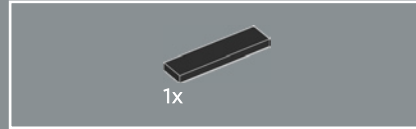
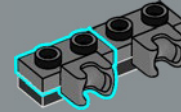

25

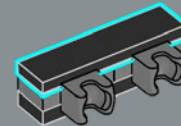



1x

2x

26



2x

27

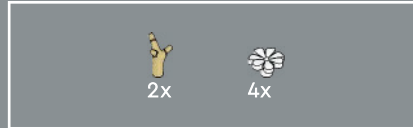
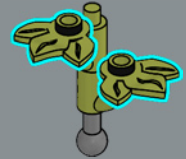

2x

4x

28

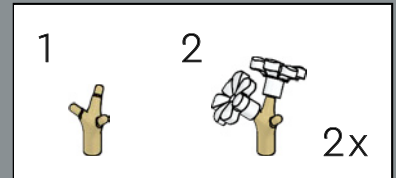

1

2

2x

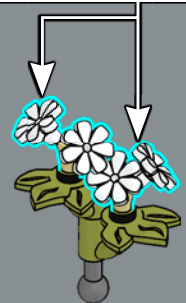



29

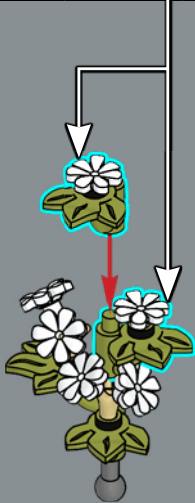
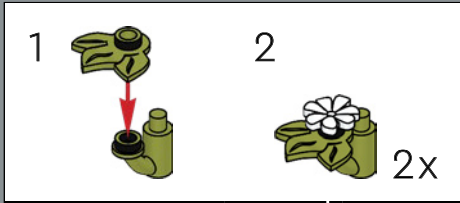

30

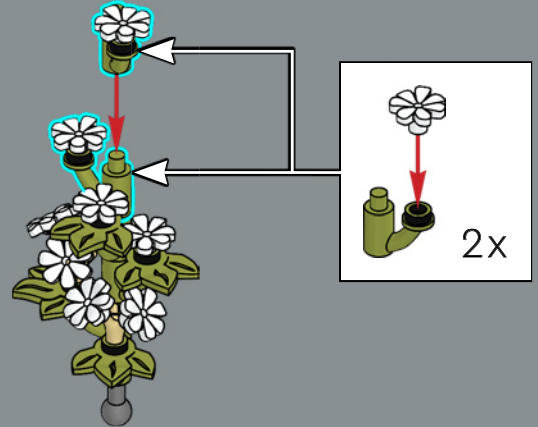

31

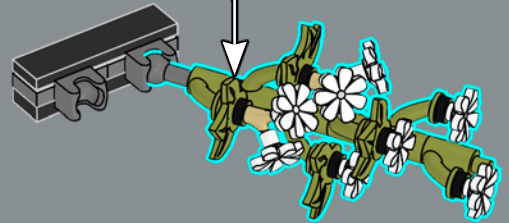

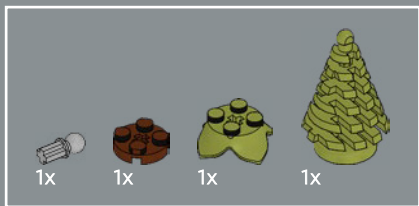

32

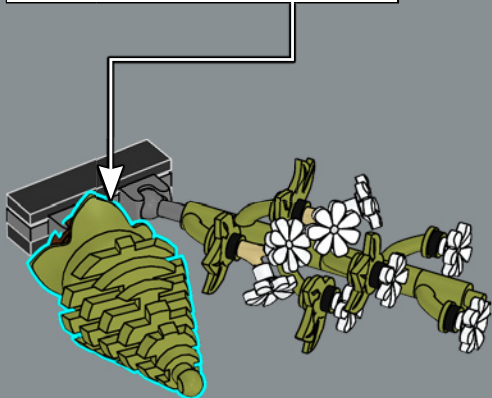
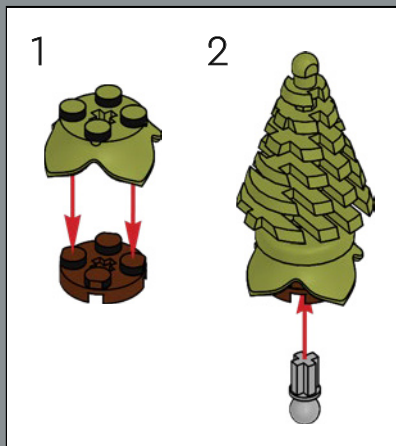

33

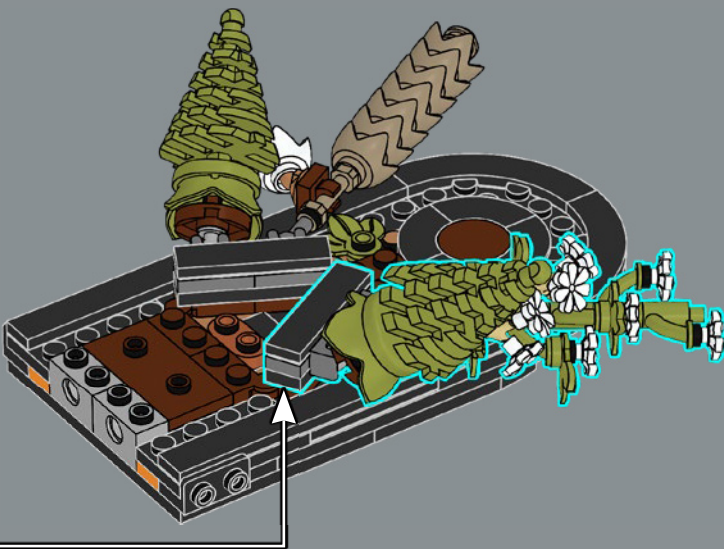

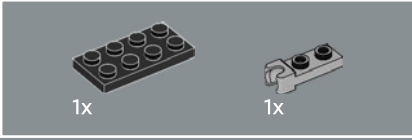
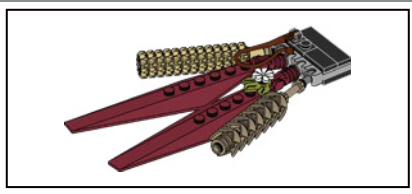

1x

1x

34

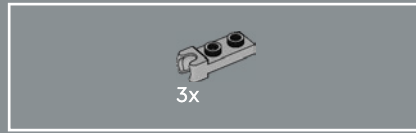
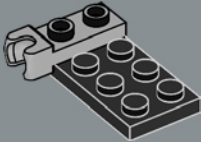

3x

35

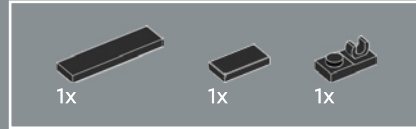
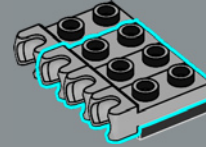

1x

1x

1x

36

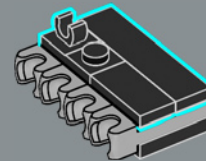

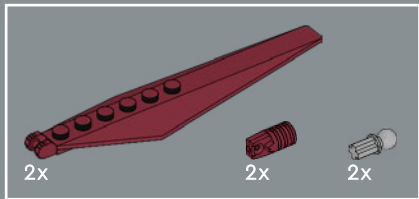

37

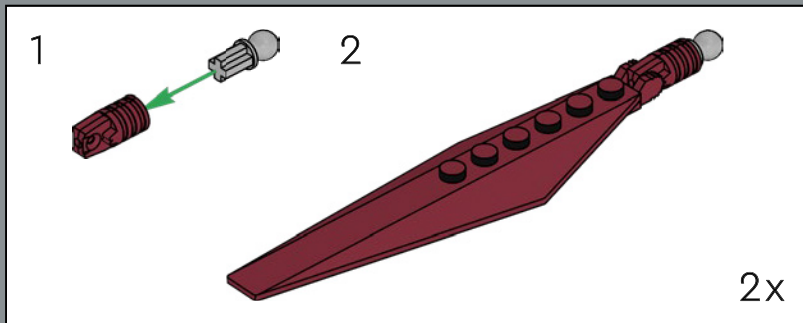

38

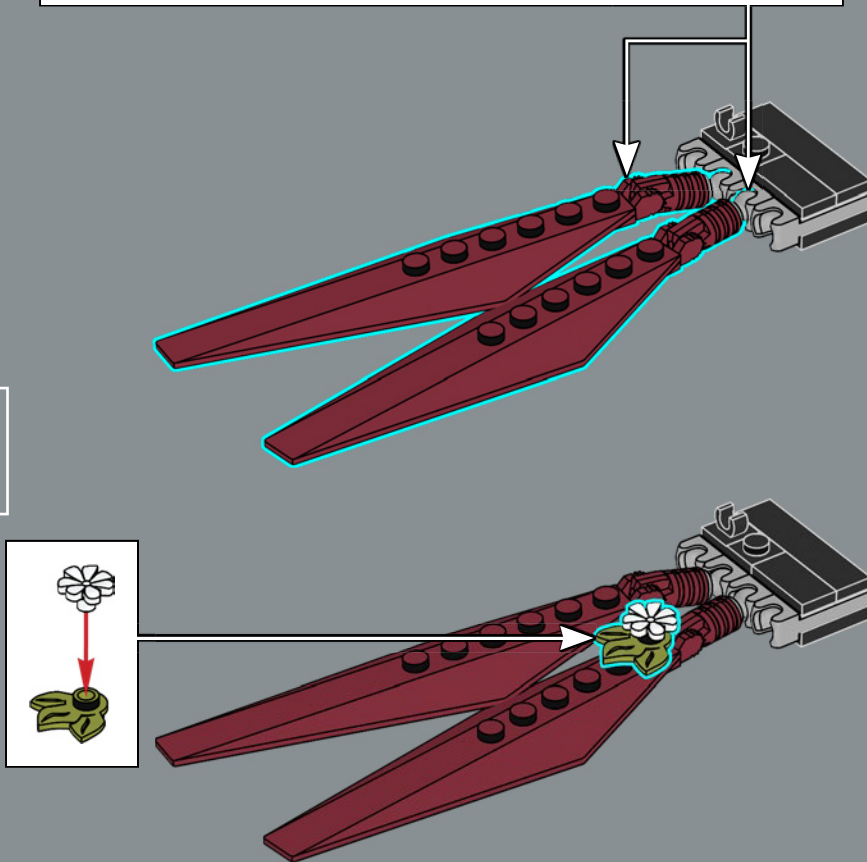

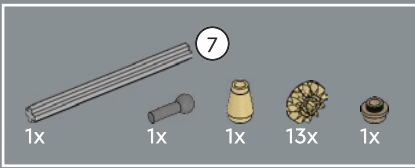

39

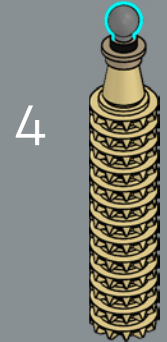
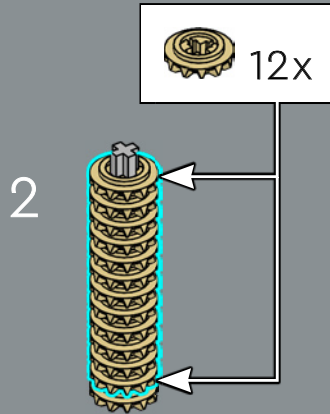

The detailed texture of the pearl millet stalks is created with a stack of conical wheels (gears).

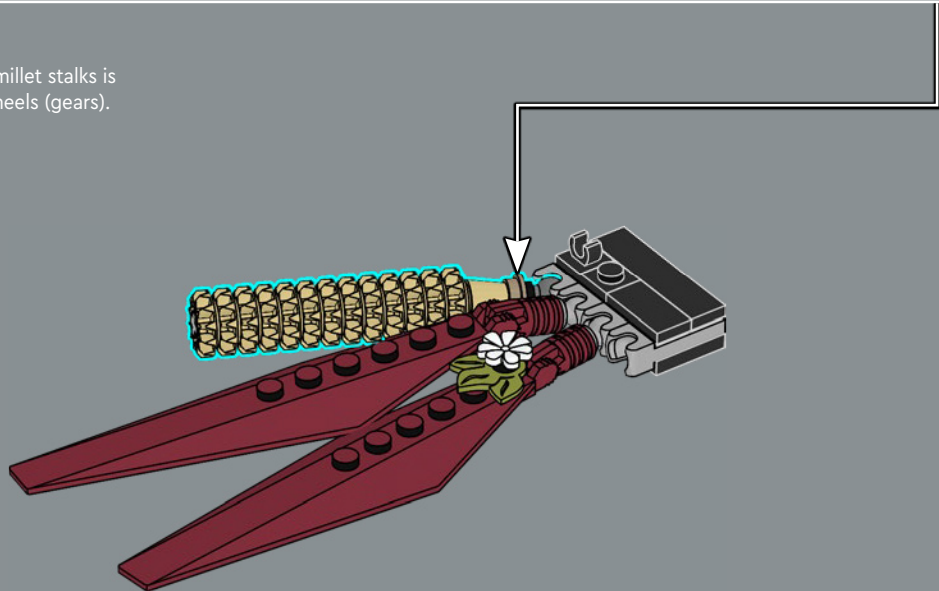



40

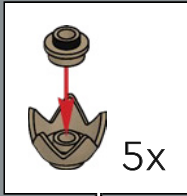
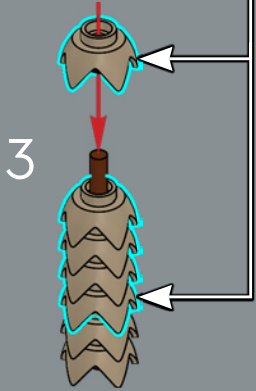
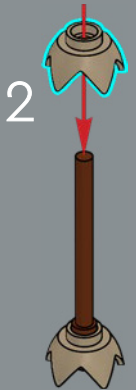
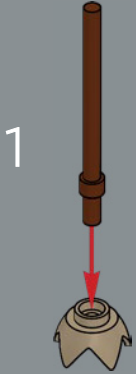

5

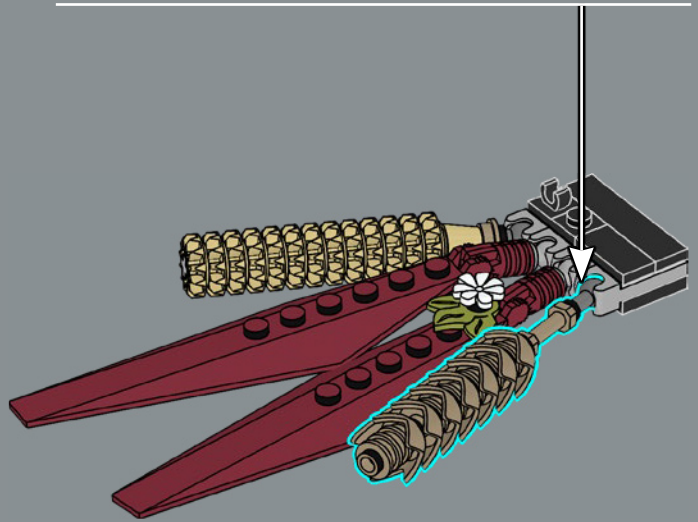
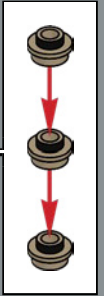



41

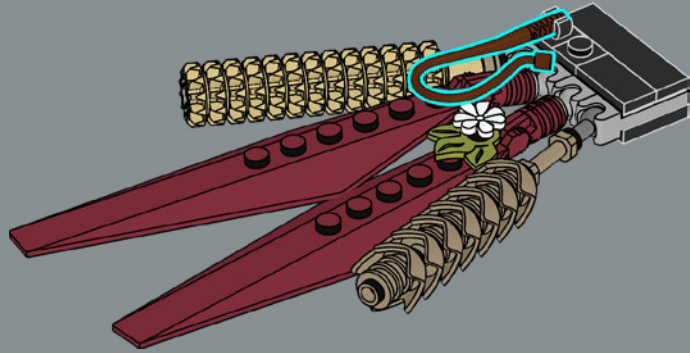

42

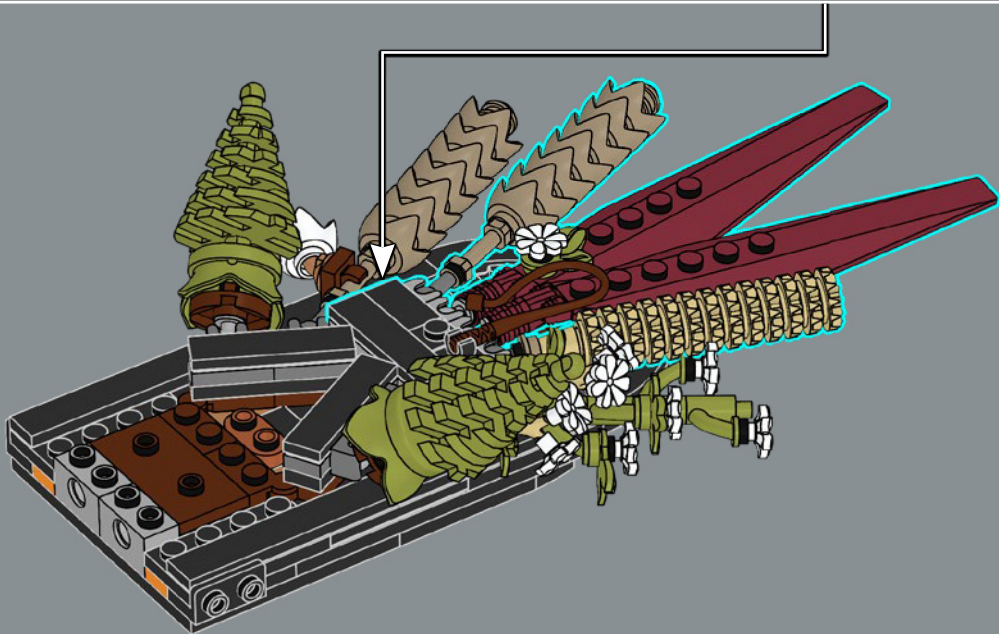

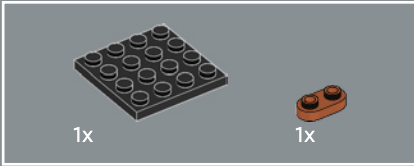
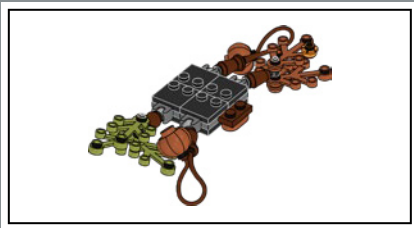

43

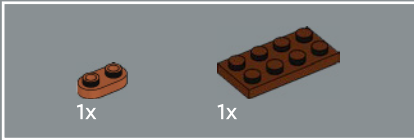
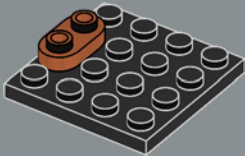

44

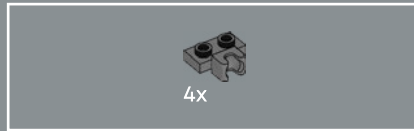
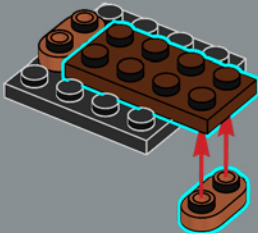

45

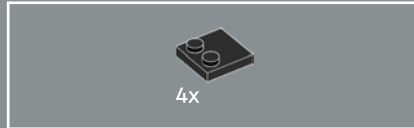
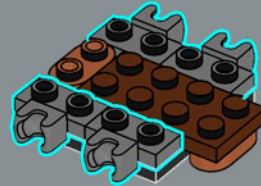

46

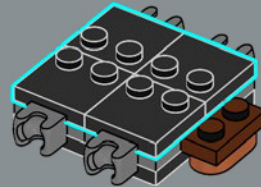



47

1

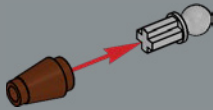

2

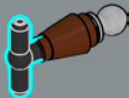

3

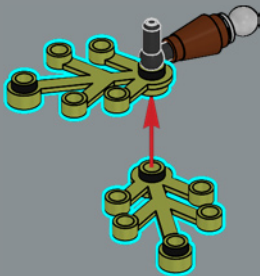

4

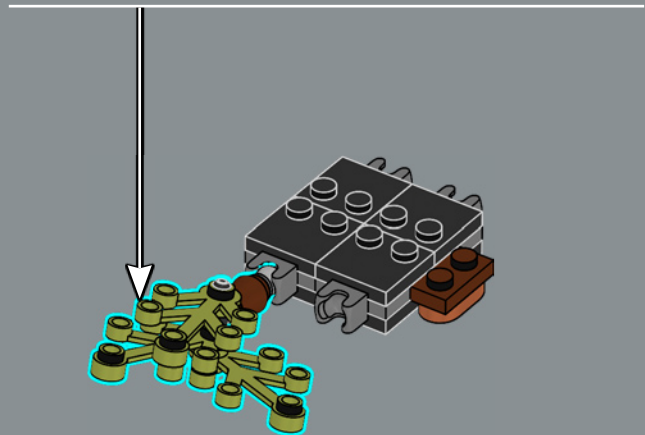
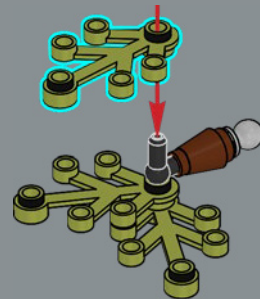

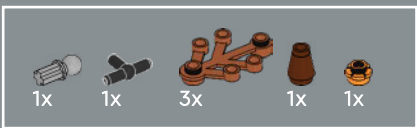

48

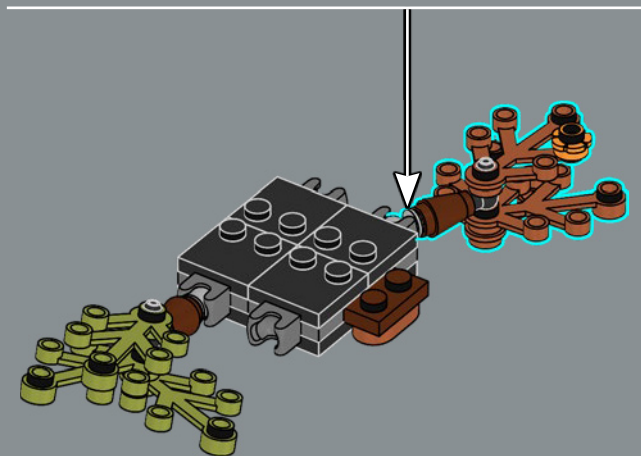
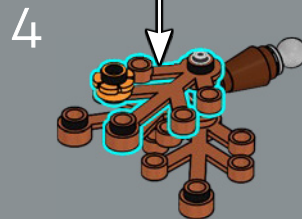
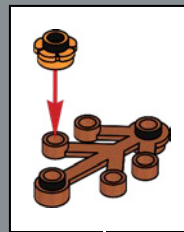
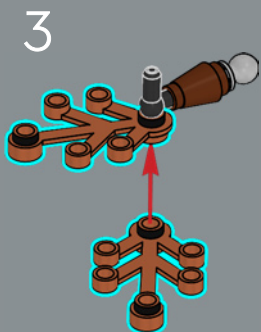
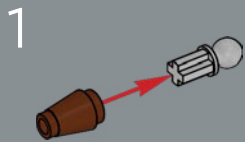



49

1

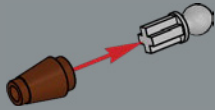

2

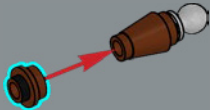

3



4



2x

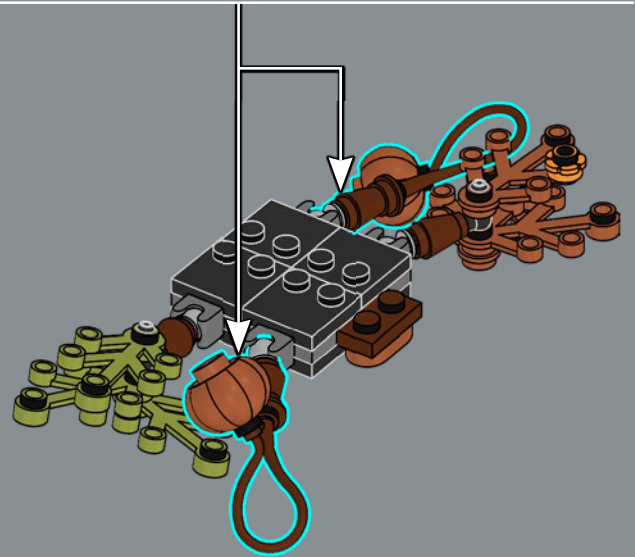

50

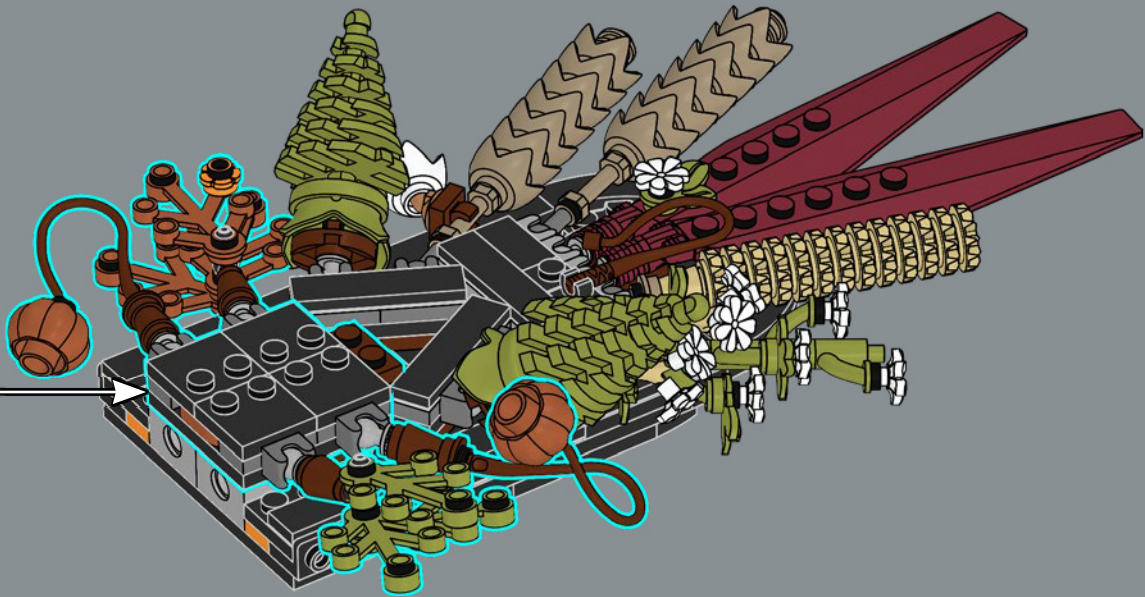

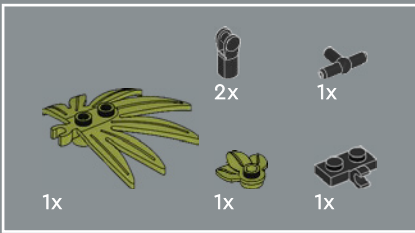

51

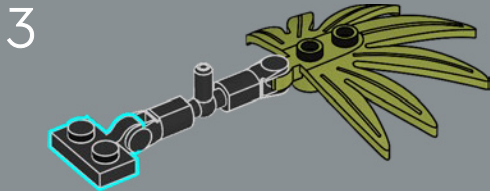
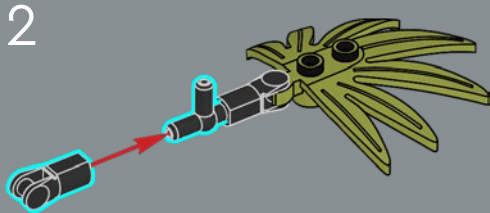
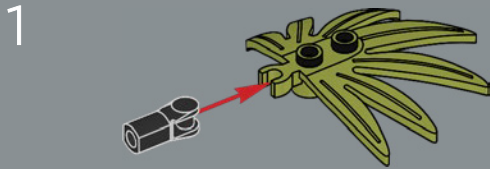

4

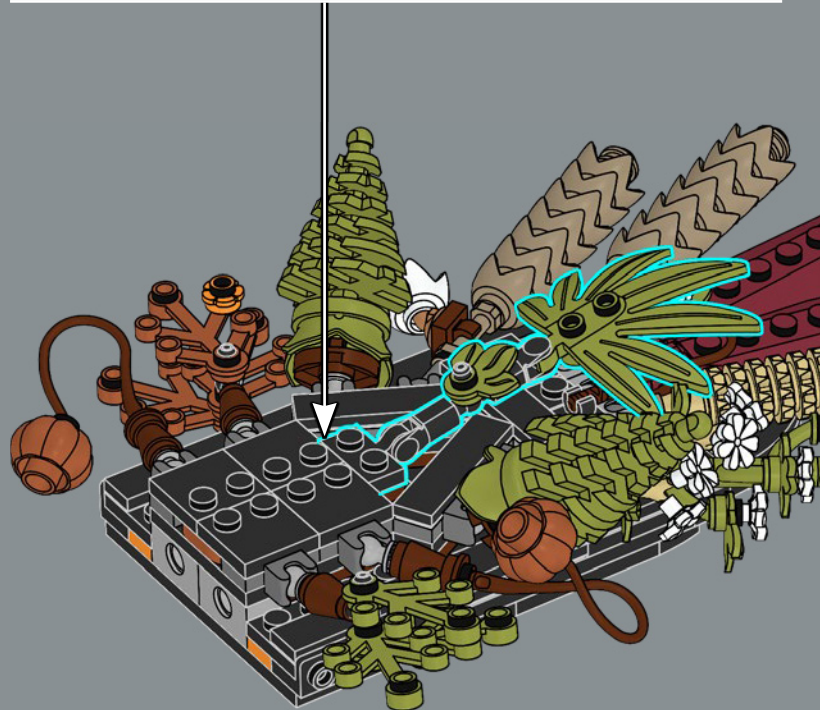
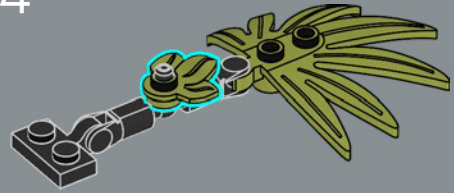



52

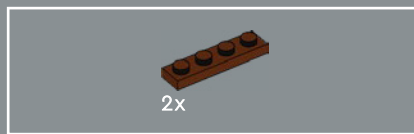
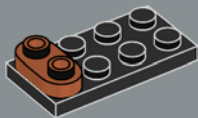

53

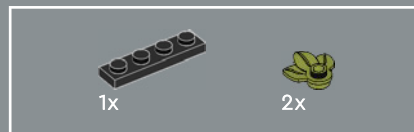

54

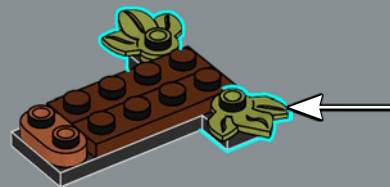
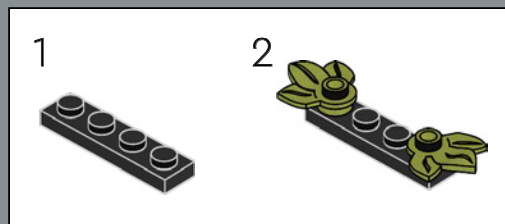

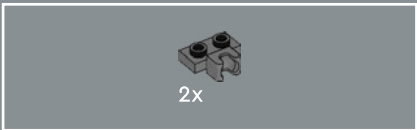

55

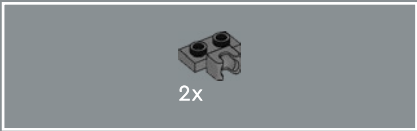
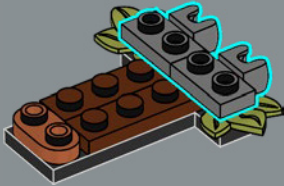

56

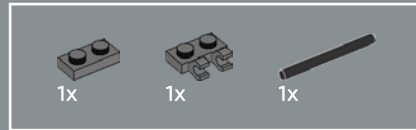
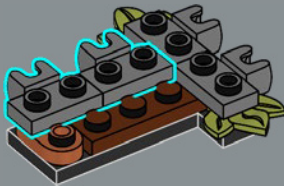

57

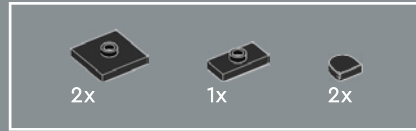
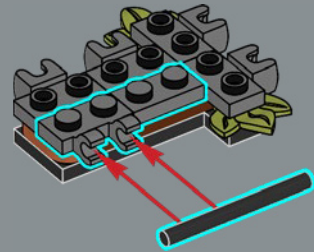

58

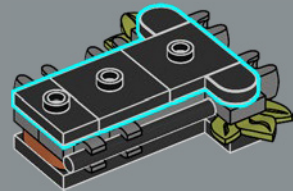

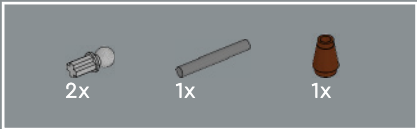

59

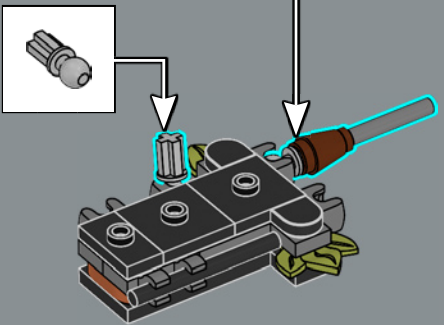
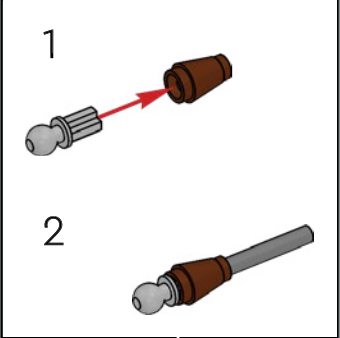

60

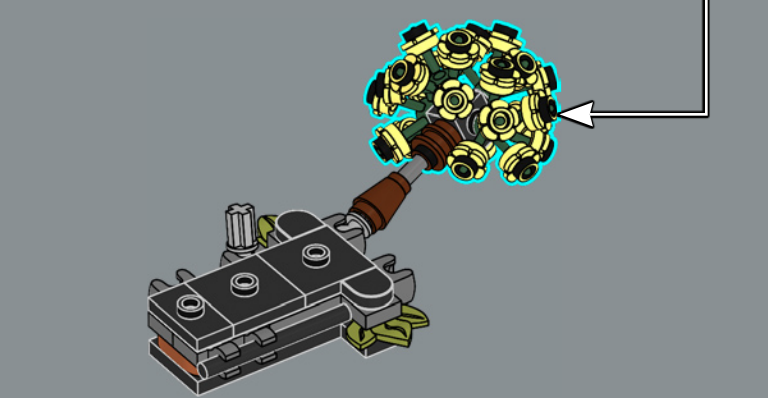
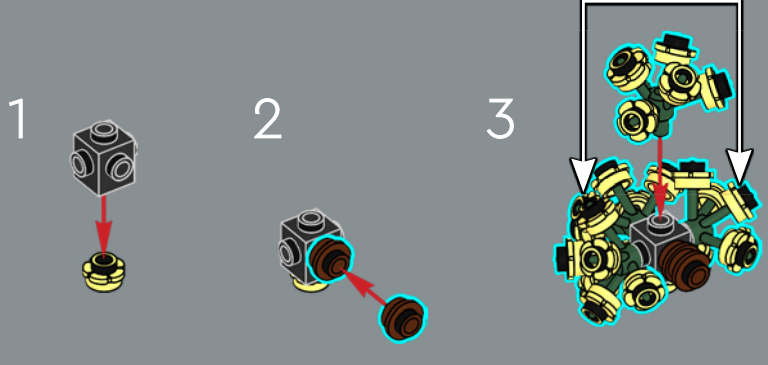
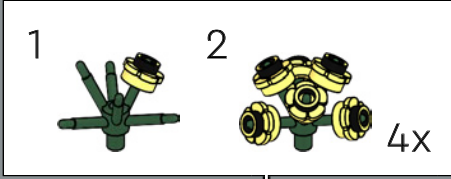

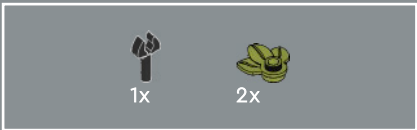

61

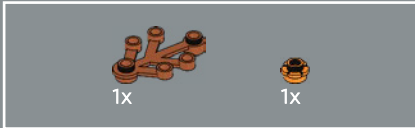
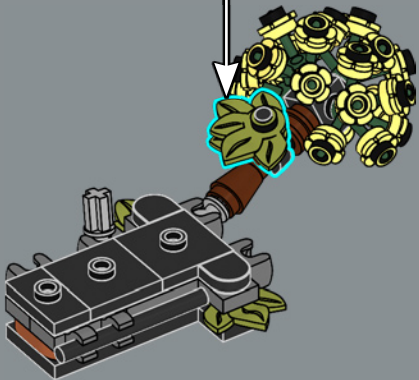
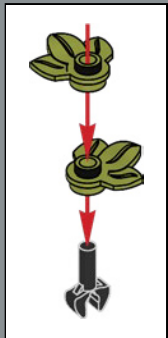

62

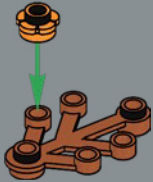

63





64

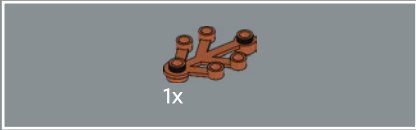
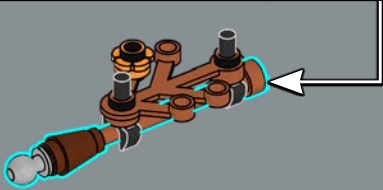
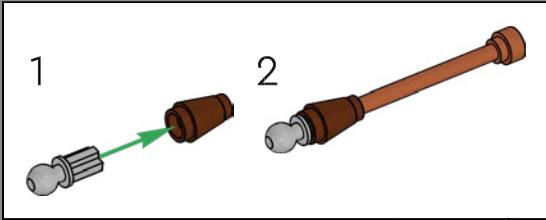

65

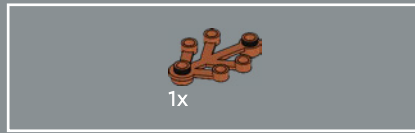

66

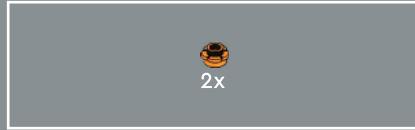
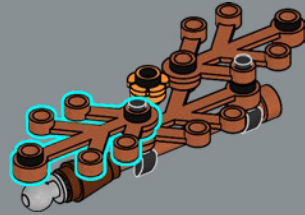

67

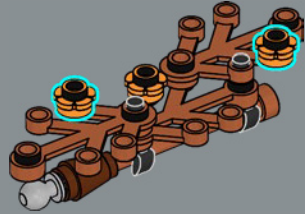



68

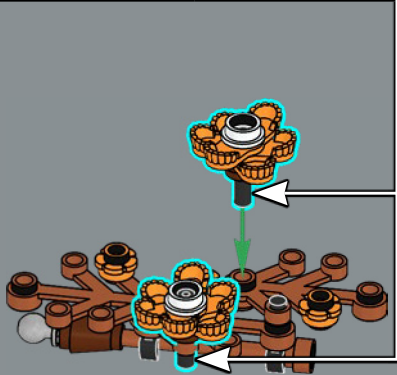
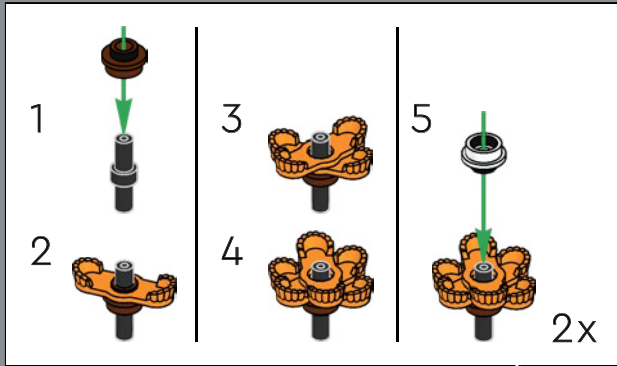

These small orange cosmos are made with a classic minifigure element: the epaulet, first used for Pirate theme Imperial Soldiers in 1989.



69

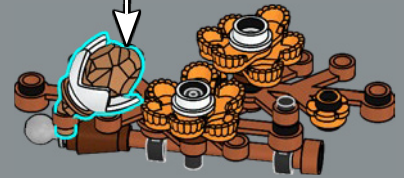
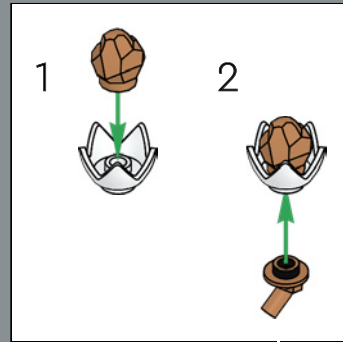

70

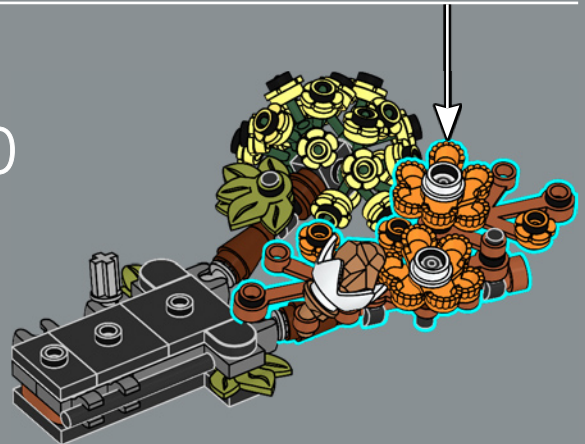



71

1

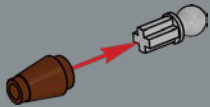

2

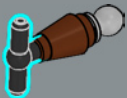

3

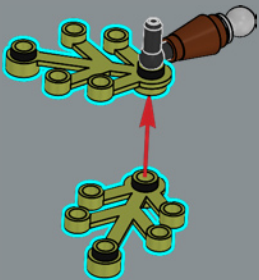

4

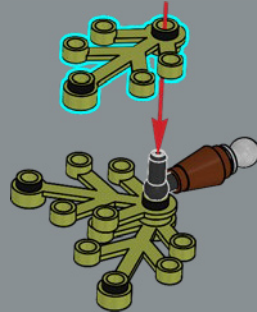

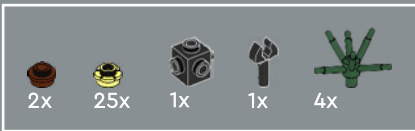

72

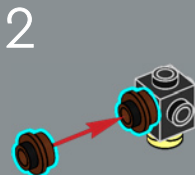
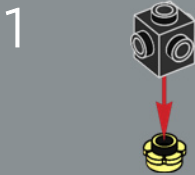

4

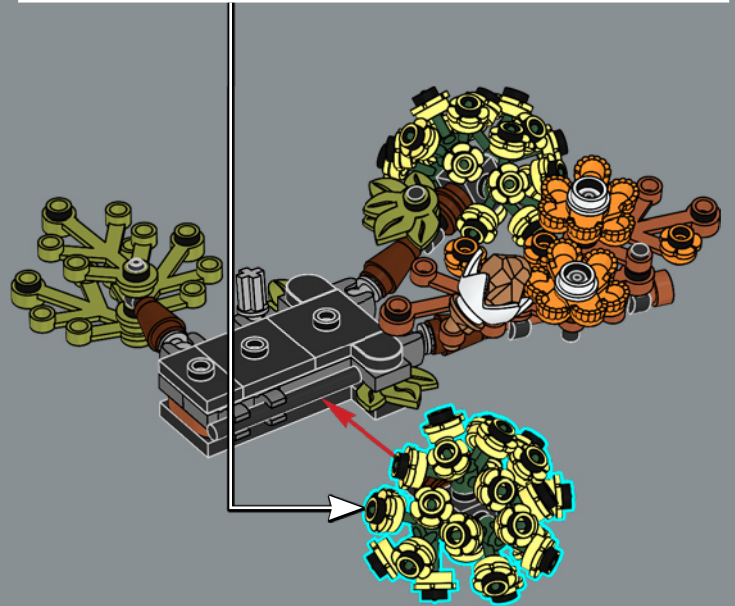
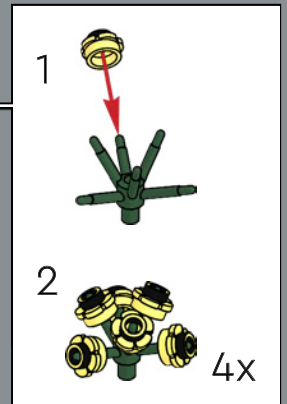
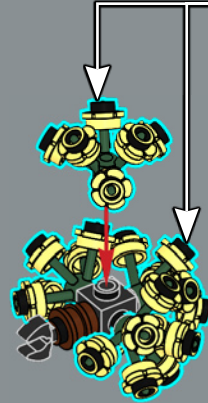

73

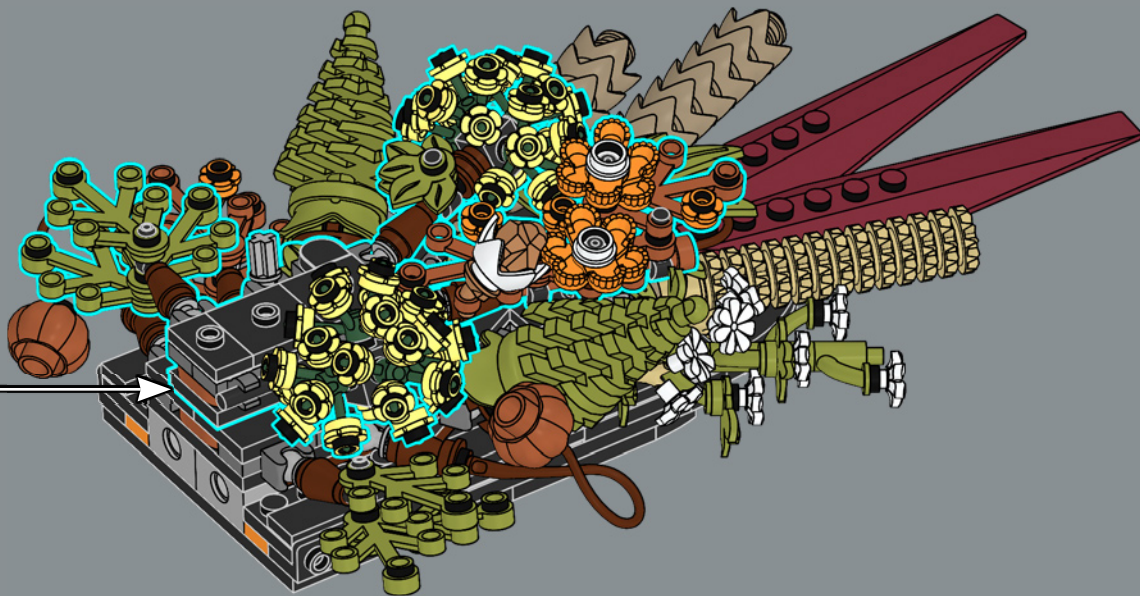



1x



3x

74

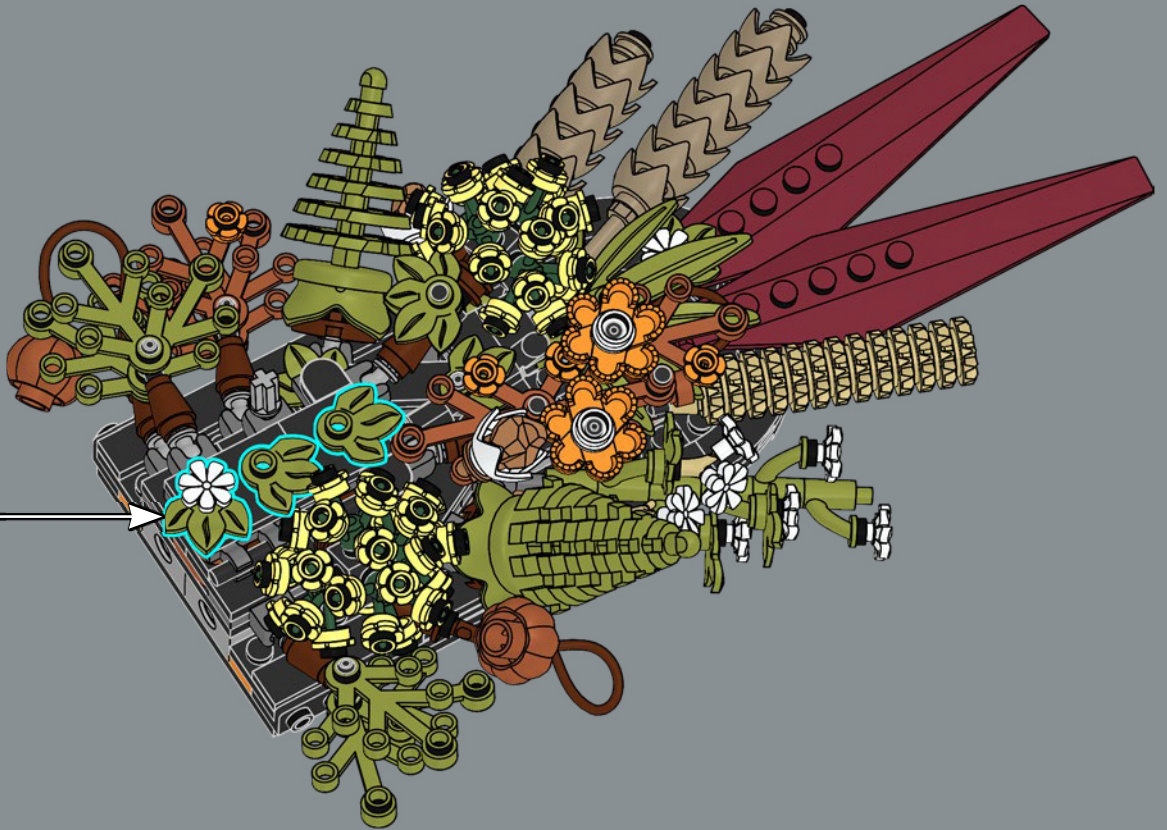
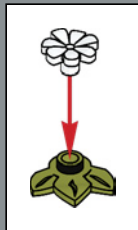

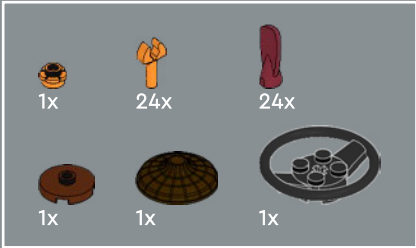
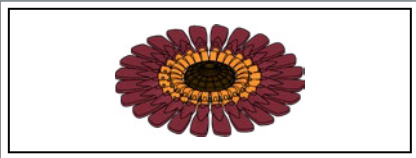

75

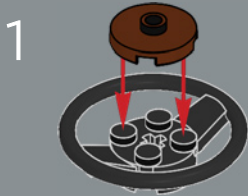

3

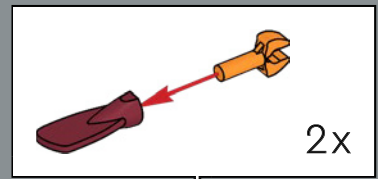
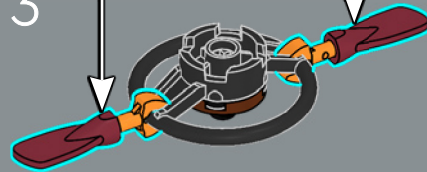

2x



4

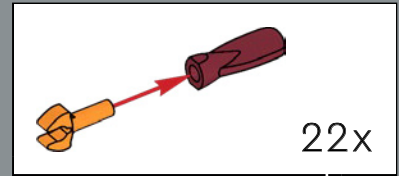

22x



5

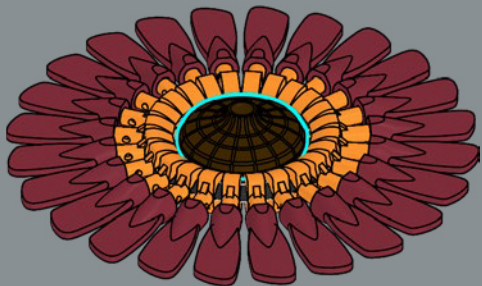

As you put together the dark red gerbera, notice that its petals are made of minifigure oar elements. It also uses a minifigure hat for the disc floret.

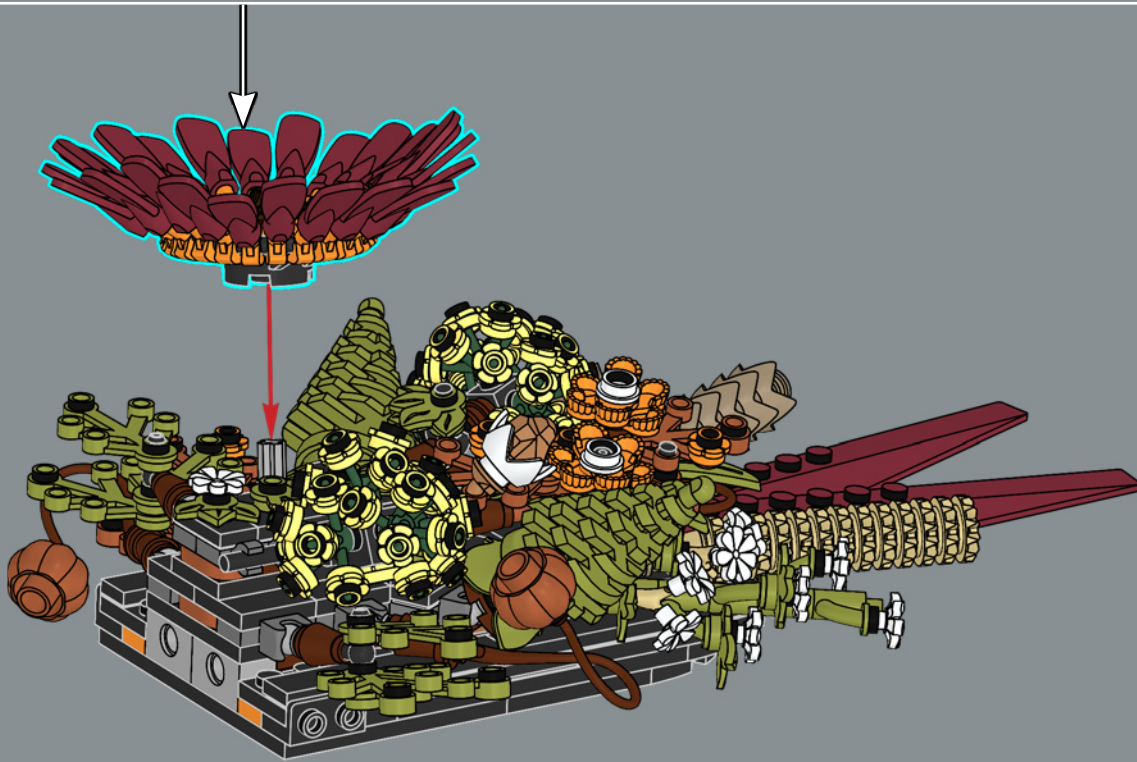

76

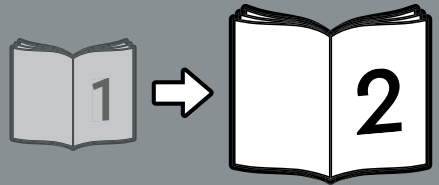
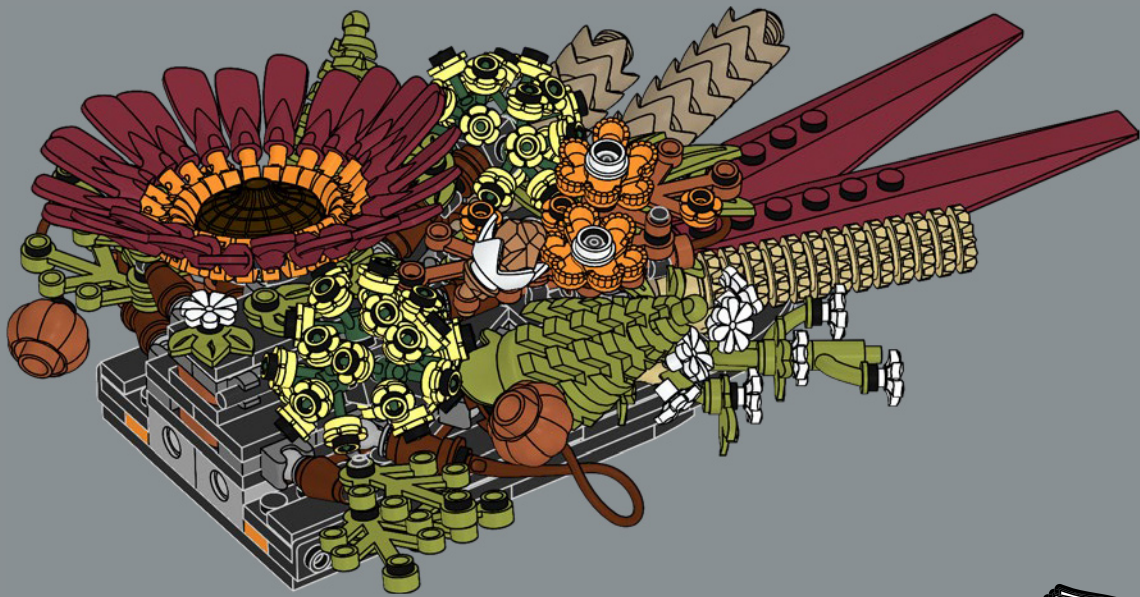



YOU COULD WIN



YOU COULD WIN

Your feedback will help shape the future development of this product series.

Visit:

DU KÖNNTEST GEWINNEN

Dein Feedback trägt zur Weiterentwicklung dieser Produktreihe bei.

Geh auf:

VOUS POURRIEZ GAGNER

Vos commentaires nous aideront à concevoir les futurs produits de cette gamme.

Visitez :

POTRESTI VINCERE TU

La tua opinione ci aiuterà a migliorare la creazione futura di questa linea di prodotti.

Visita:

PUEDES GANAR

Tu opinión contribuirá al futuro de esta serie de productos.

Visita:

轻松获奖

您的反馈将有助于我们在今后改进本产品系列。

请访问：

LEGO.com/productfeedback

You also have the chance to win a LEGO® set.

Terms and conditions apply.*

Außerdem hast du die Chance, ein LEGO® Set zu gewinnen.

Es gelten die Teilnahmebedingungen.*

Vous pourriez également gagner un ensemble LEGO®.

Des conditions s'appliquent.*

Hai anche la possibilità di vincere un set LEGO®.

Termini e condizioni sono applicabili.*

También tienes la oportunidad de ganar un set LEGO®.

Aplican términos y condiciones.*

您还有机会赢取乐高®套装。

条款和条件适用。*

*[LEGO.com/productfeedback-terms](https://www.lego.com/productfeedback-terms)

GROW YOUR
COLLECTION
OF LEGO®
BOTANICAL
MODELS



10280
Flower Bouquet



10311
Orchid

10313
Wildflower Bouquet



10281
Bonsai tree



6x
6168642



2x
6210272



24x
6338913



4x
6259700



2x
6378415



2x
4529237



4x
6347292



6x
6324176



26x
4565452



4x
6431730



4x
6330588

50



1x
6391341



2x
370126



2x
6267487



6x
306926



2x
302326



2x
6092585



10x
6192346



2x
4565323



2x
6133722



6x
243126



6x
371026



4x
4560182



12x
302026



2x
6350415



4x
6347310



2x
6313116



4x
6020193



1x
6350725



4x
6256435



4x
6210270



12x
663626



2x
6058118

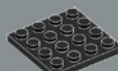

4x
4243819



7x
346026

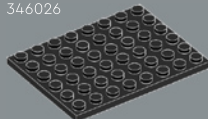

2x
303626



2x
4514845



4x
287726



4x
473326



6x
6371584



2x
6116604



6x
6321194



8x
6278152



4x
6279875



8x
6104209



8x
6191630



3x
6325190



1x
6299938



4x
6171264



4x
6101857



4x
6133200



8x
6369194



13x
6022079



2x
6400293



3x
6426472



1x
6074892



2x
6219673



2x
4177932



4x
6106027



8x
6030521



8x
6214234



18x
6426228



24x
6278159



1x
6149656

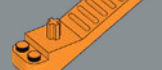

1x
6240515

15x
6426470

4x
6285465

31x
6398008

4x
6426468

4x
6426464

10x
6268815

2x
6313102

2x
6348057

4x
6313124

14x
4529242

4x
6172922

1x
6257604

3x
4211190

2x
6307618

2x
4211186

17x
6215659

2x
6075213

4x
4211159

1x
6102360

4x
6170468

5x
6359864

8x
6416695

2x
4211440

4x
6326478

8x
6043639

22x
4211375

2x
4211805

1x
4211063

2x
6388119

23x
6146792

2x
6350292

2x
6310596

9x
6364352

100x
6426463

1x
6384238

1x
6384589

1x
6416732

4x
6431549

16x
6398343

4x
6102998

6x
6093494

2x
6347304

1x
6177189

4x
6400315

4x
6432504

2x
6299413

34x
6300322

28x
6431686

24x
6426473

4x
6431687

4x
6426471

7

 [LEGO.com/service](https://www.LEGO.com/service)





6487193



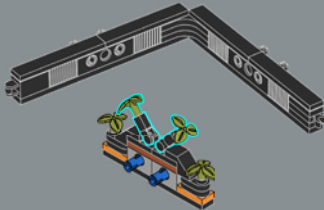
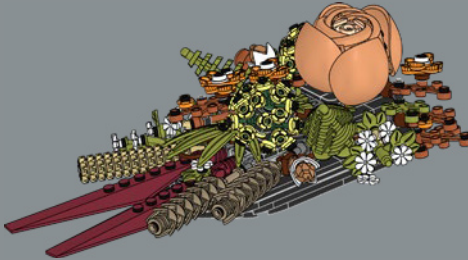
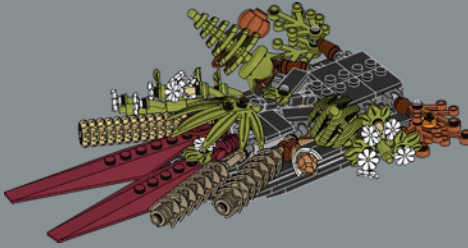

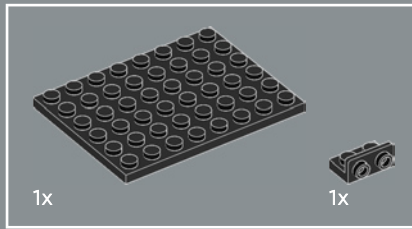

77

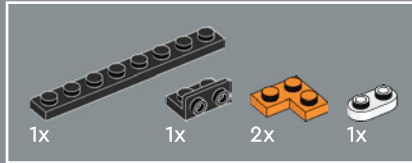
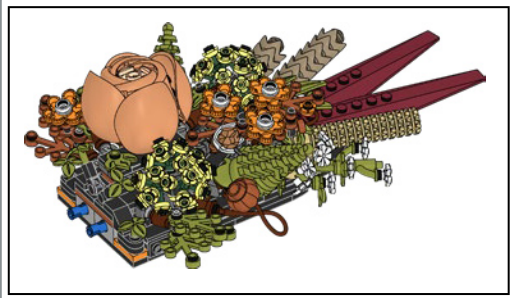
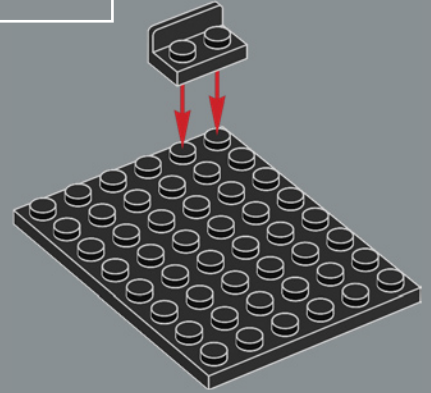

78

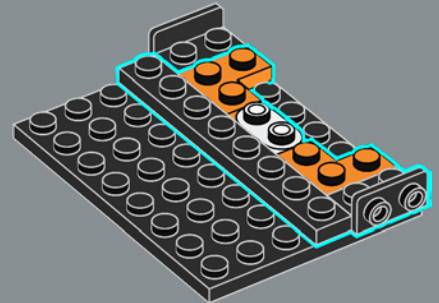

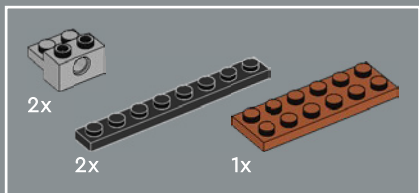

79

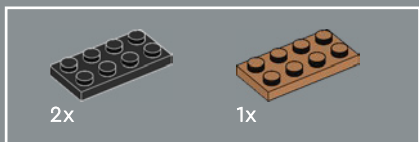
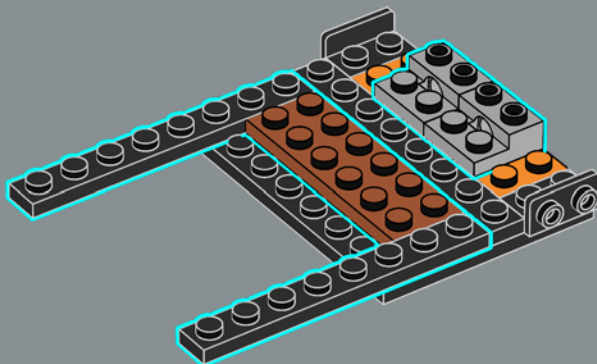

80

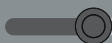
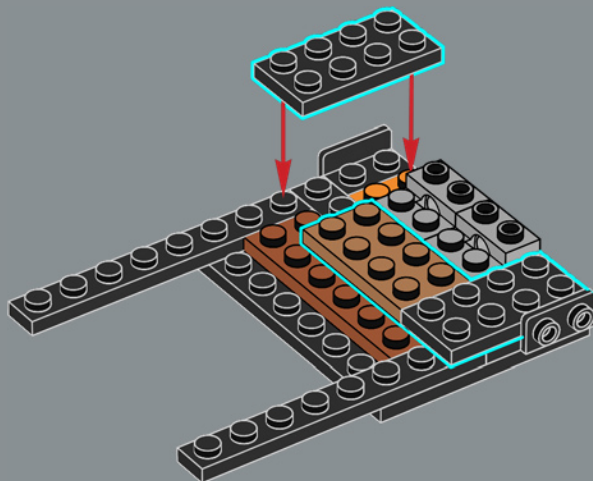

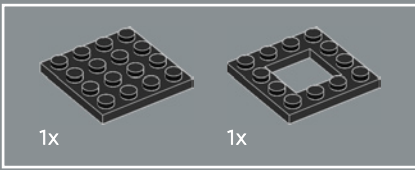

81

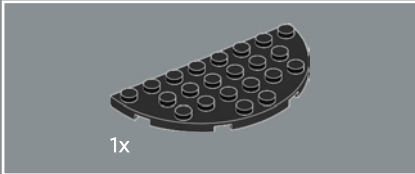
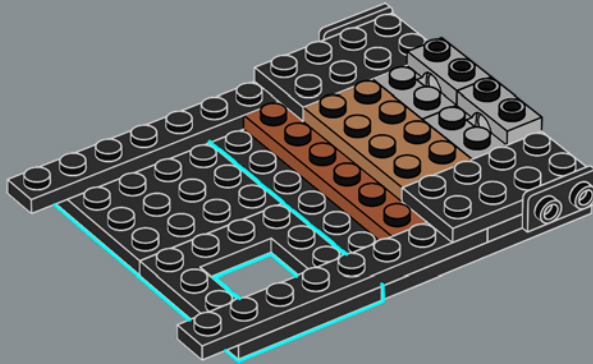

82

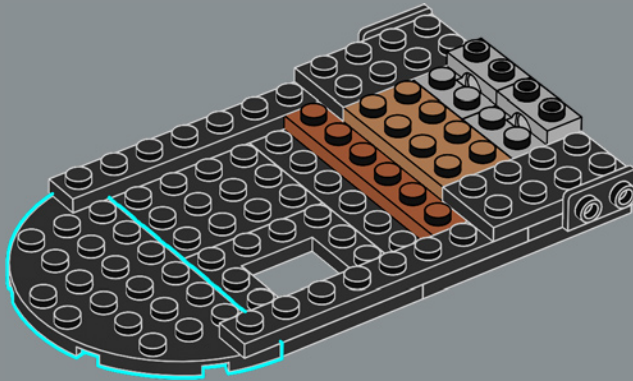

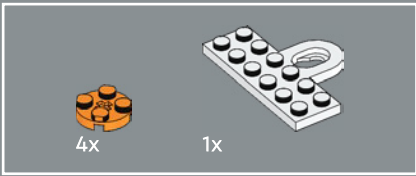

83

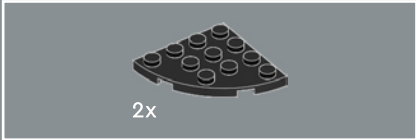
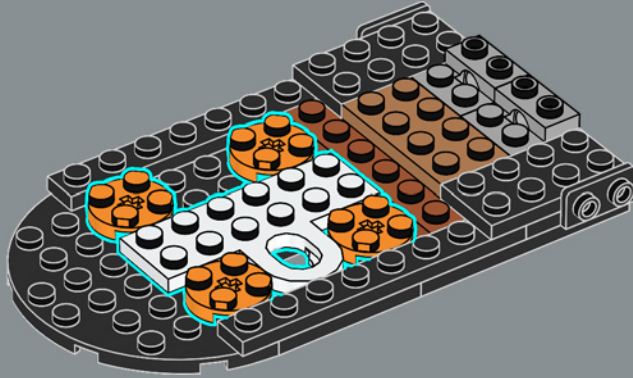

84

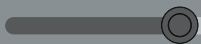
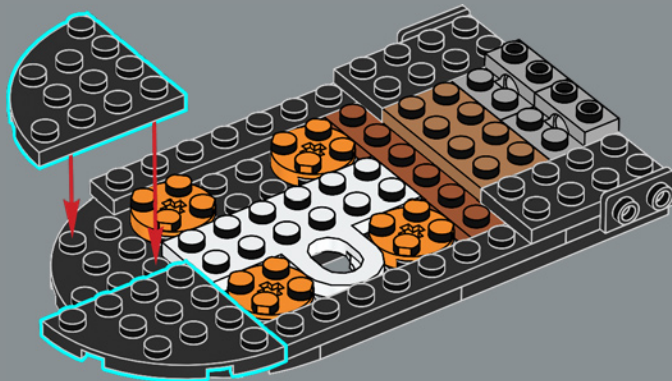

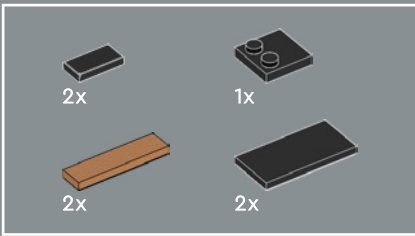

85

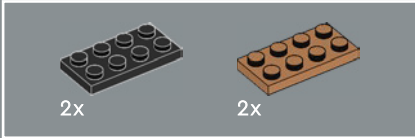
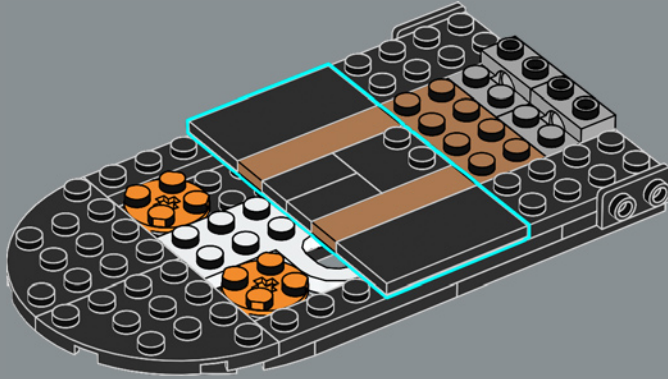

86

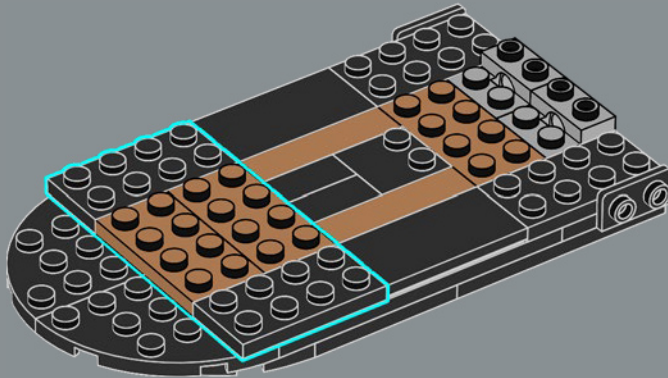

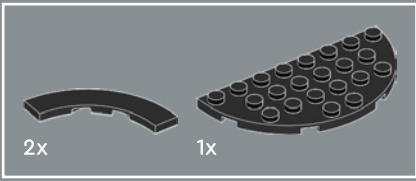

87

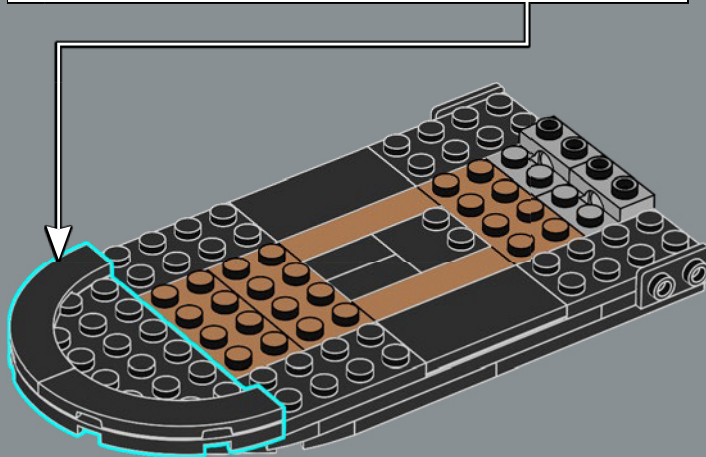
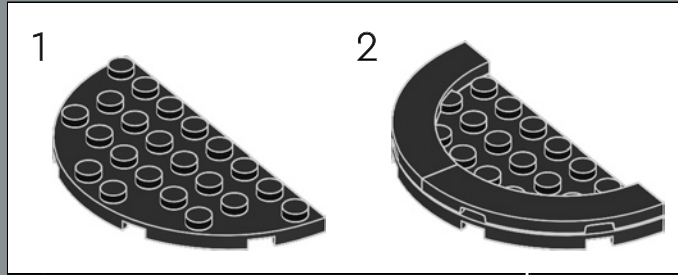

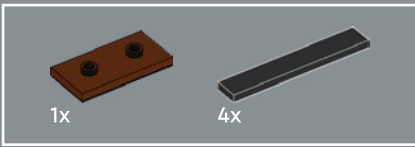

88

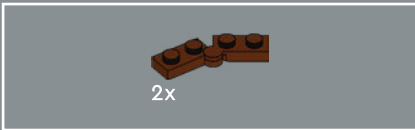
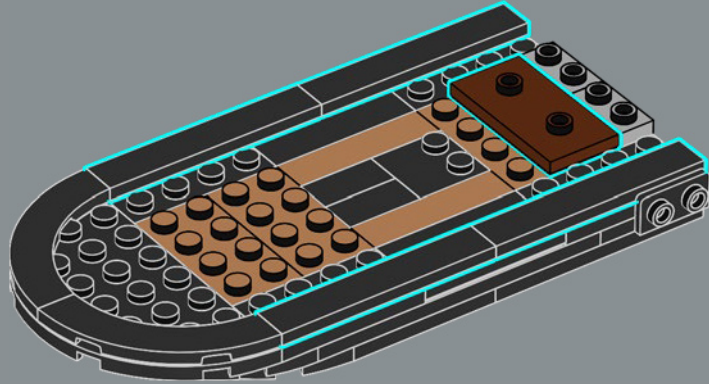

89

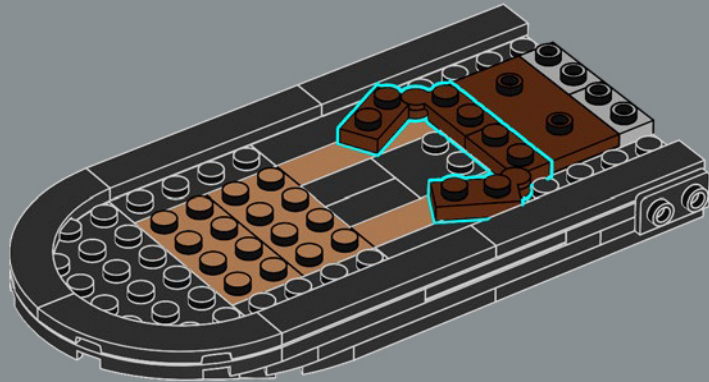

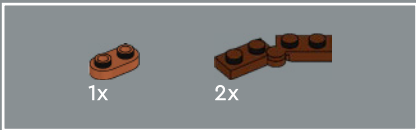

90

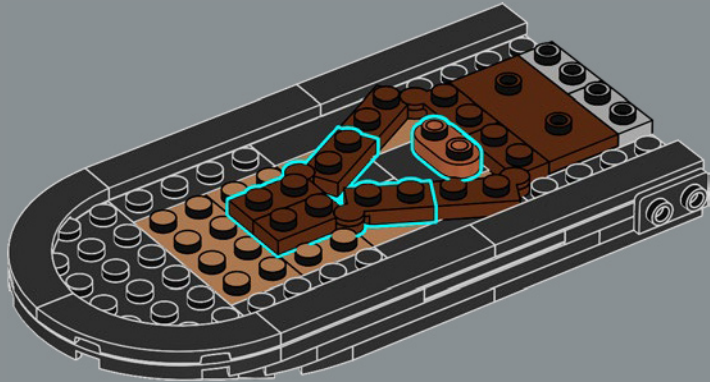

91

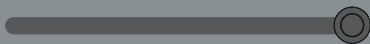

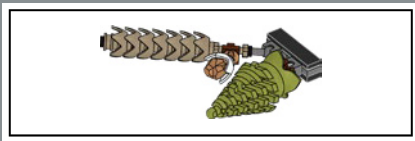

92

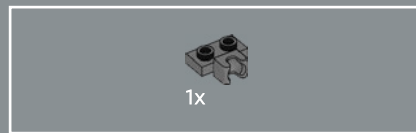
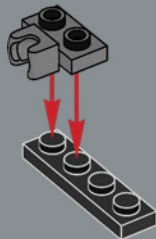

93

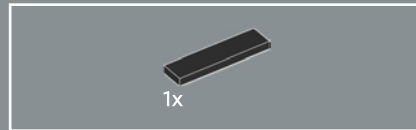
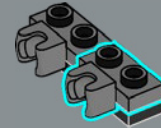

94

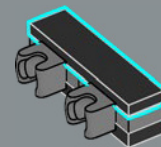



95

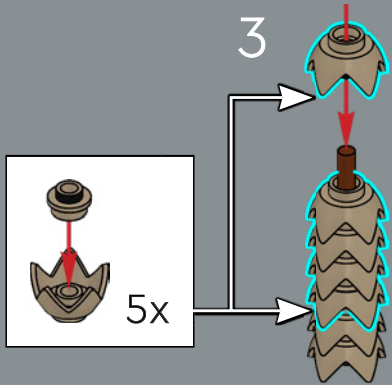
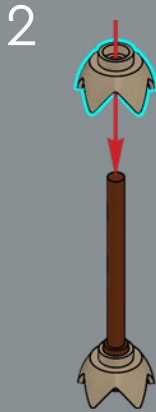
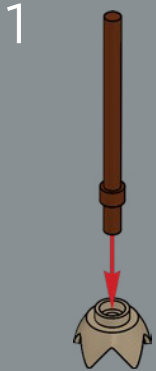



5

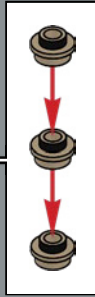

1x



1x



1x



1x

96

1



2



3

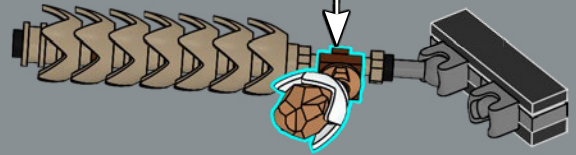

The stalks of wheat use nested crown elements to give the wheat its corrugated appearance.

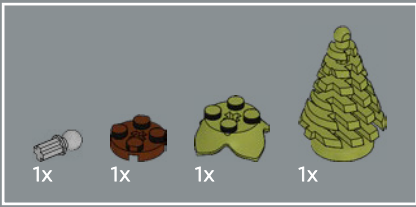

97

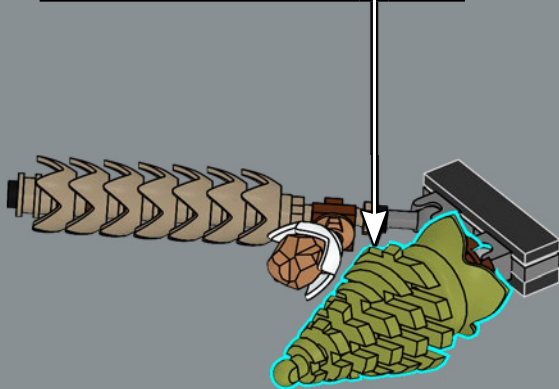
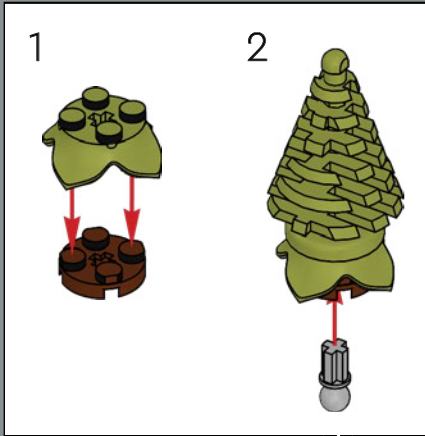

98



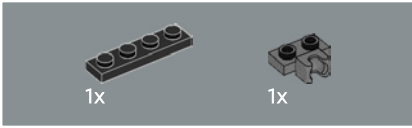
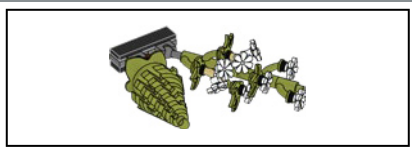

99

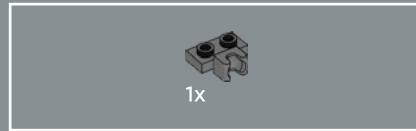
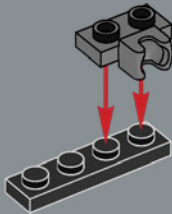

100

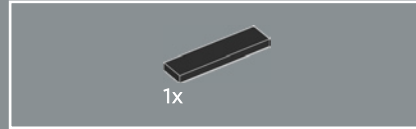
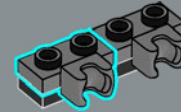

101

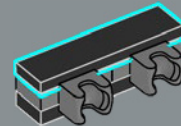

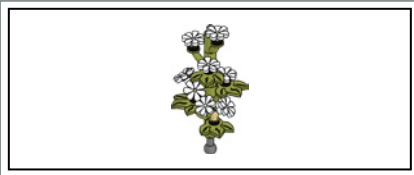

102



103

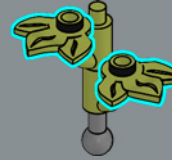

104

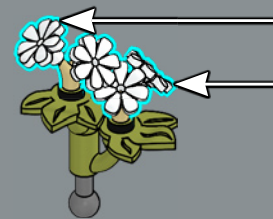
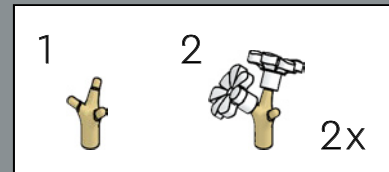



105

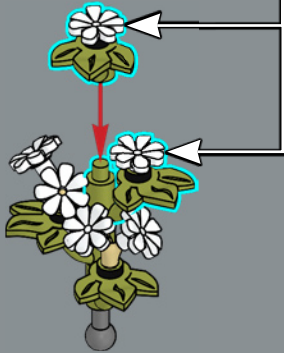
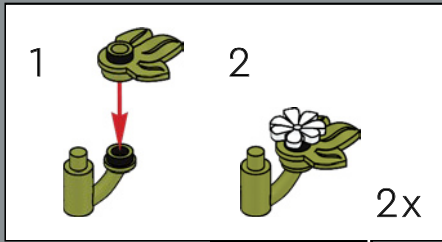

106

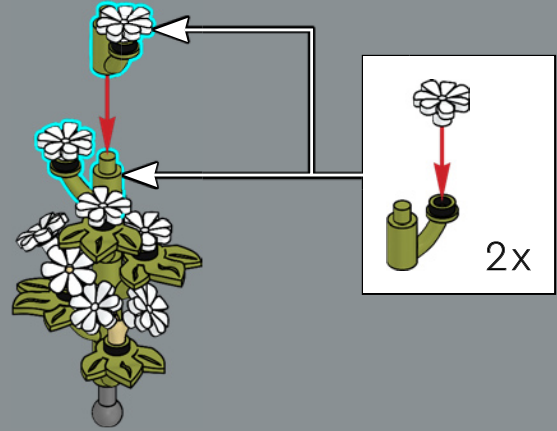

107

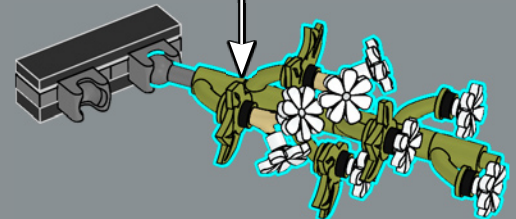

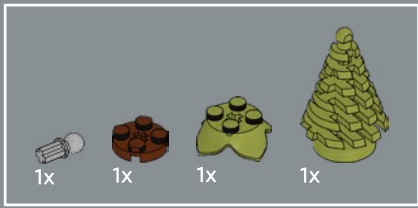

108

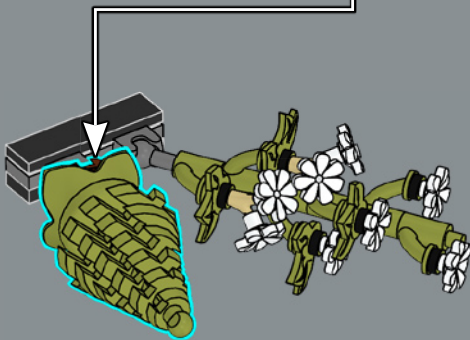
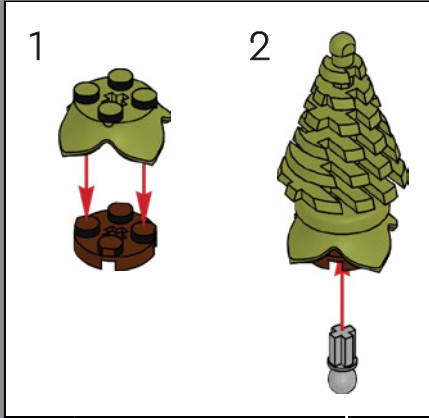

109

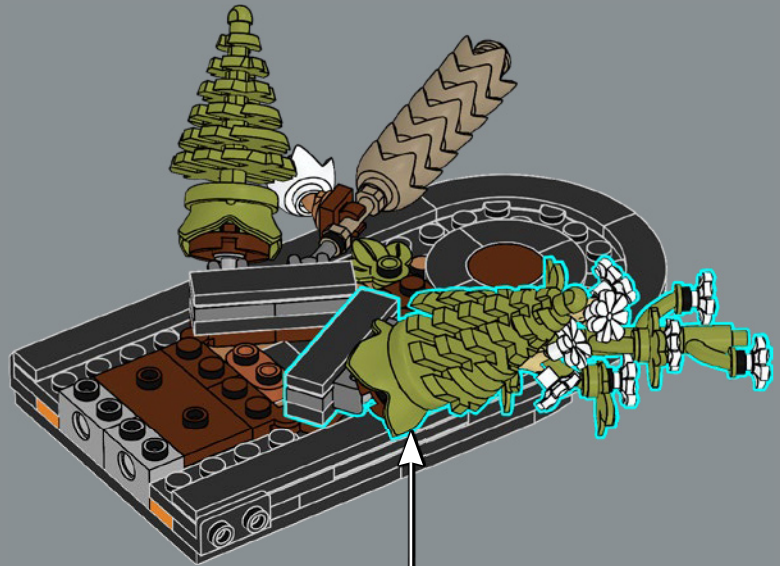

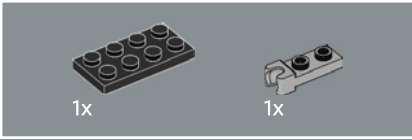
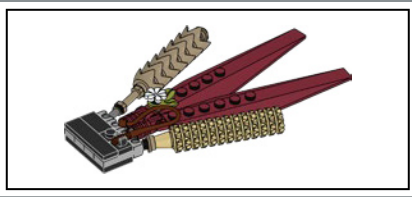

110

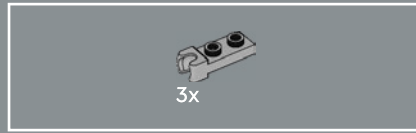

111

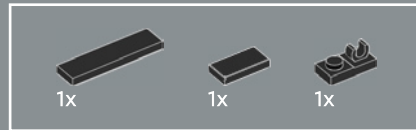
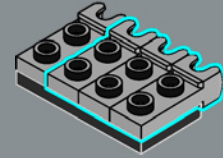

112

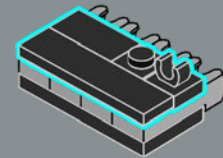

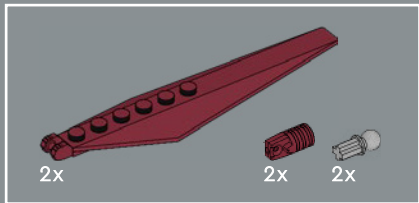

113

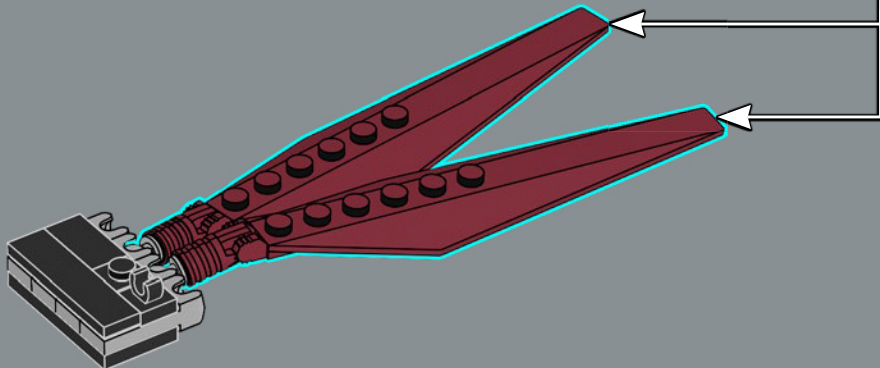
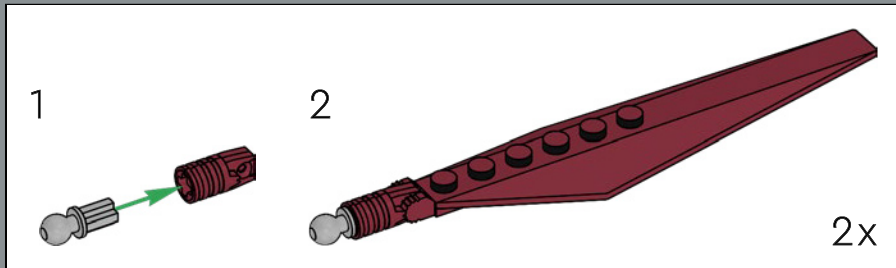

114

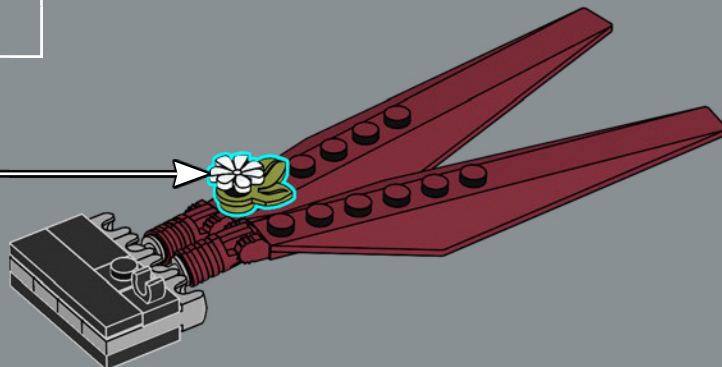
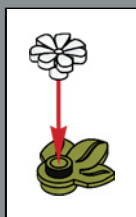



115

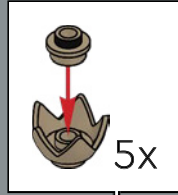
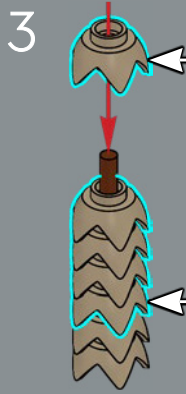
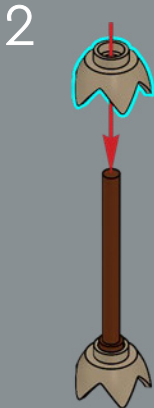
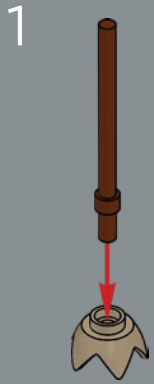

5

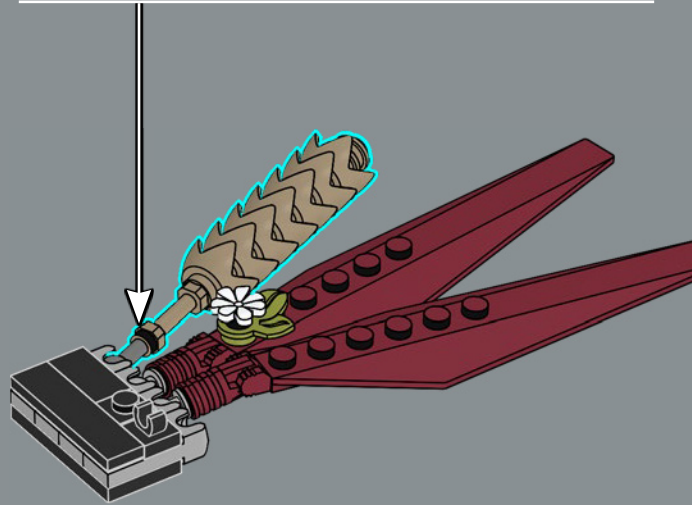
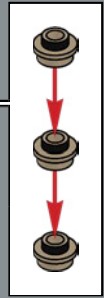

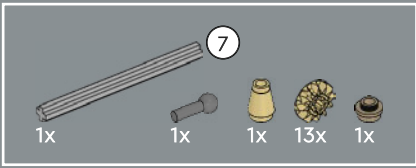

116

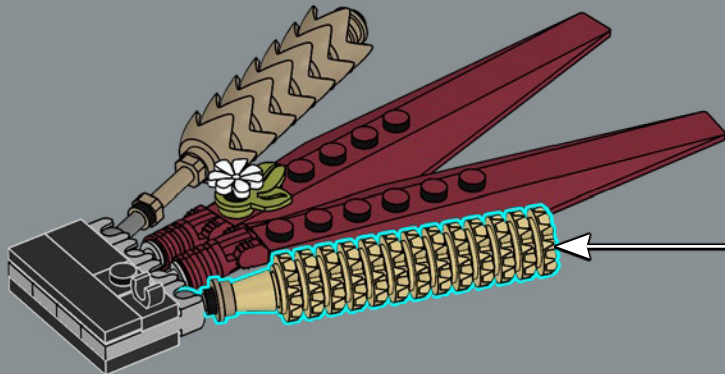
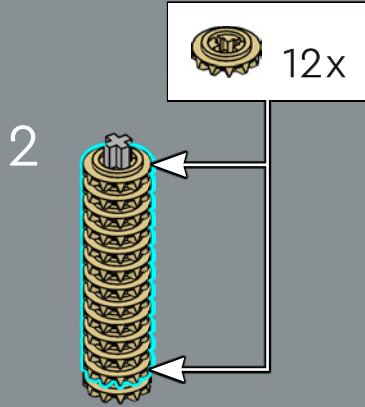



117

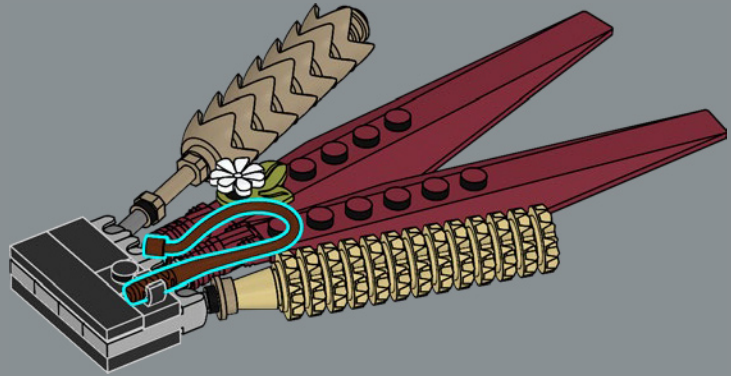

118

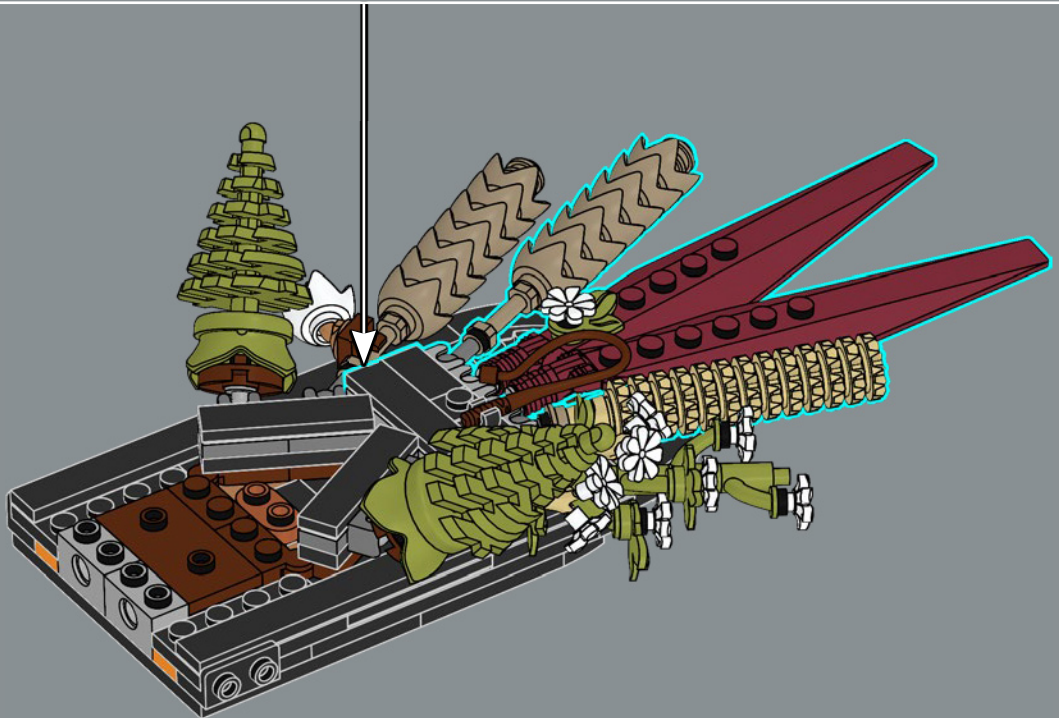

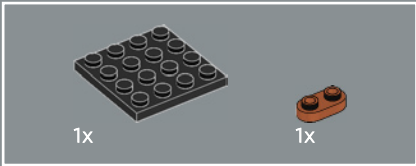
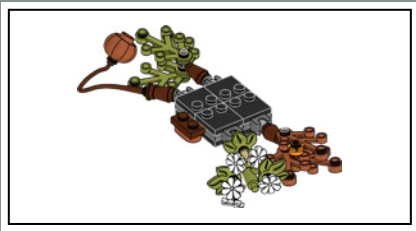

119

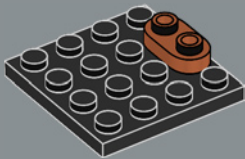

120

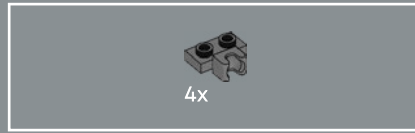
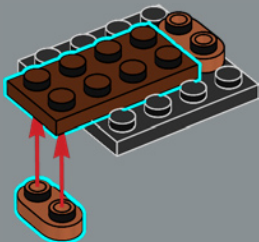

121



4x

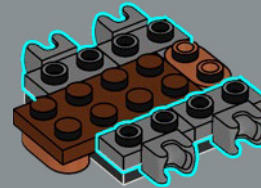

122



4x

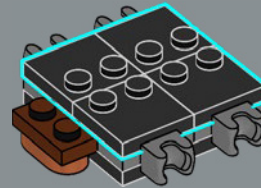



123

1

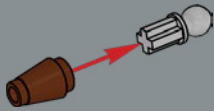

2

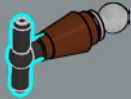

3

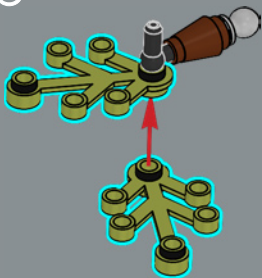

4

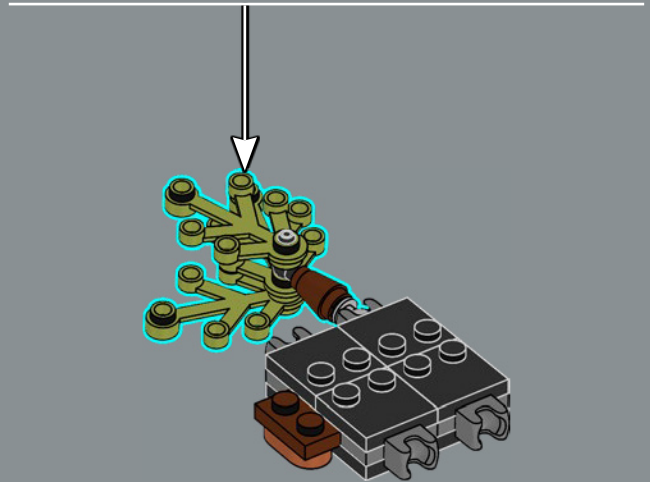
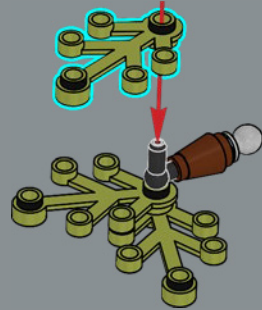



124

1

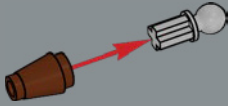

2

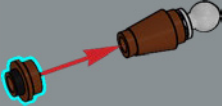

3

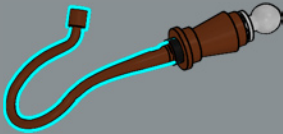

4

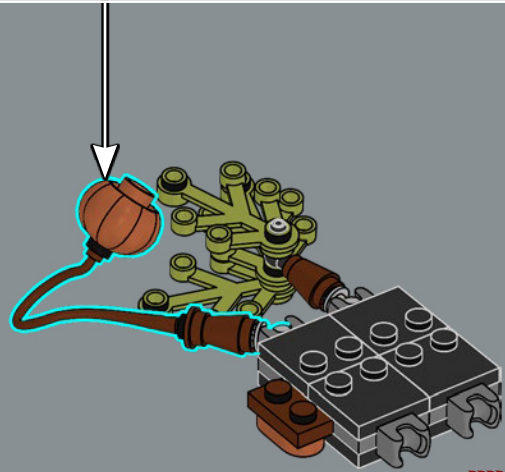

The peculiarly named bladder cherry is built with a LEGO® element that is usually used as vegetables, (like pumpkins or lanterns) and a flexible brown whip element.





125

1

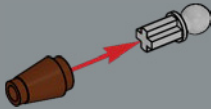

2



3

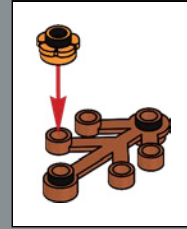
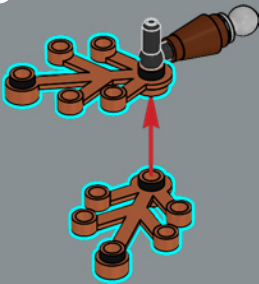

4

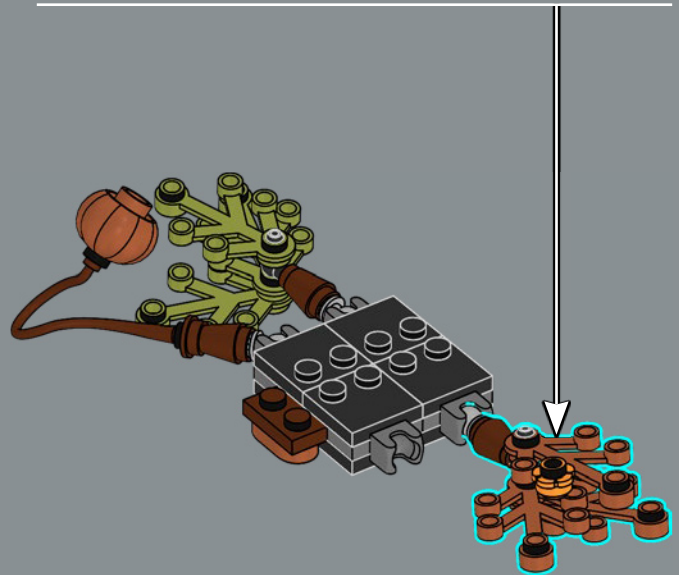

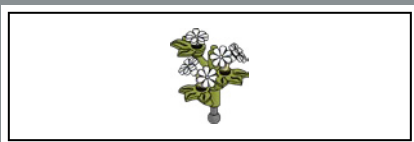

126



127



128

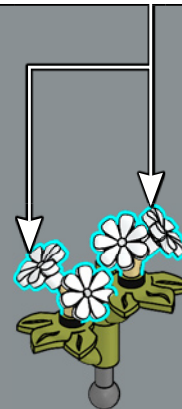
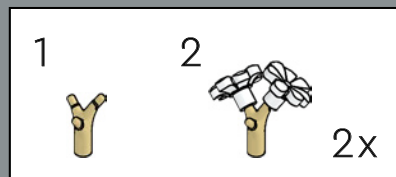



129

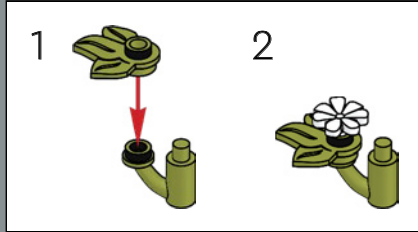

130

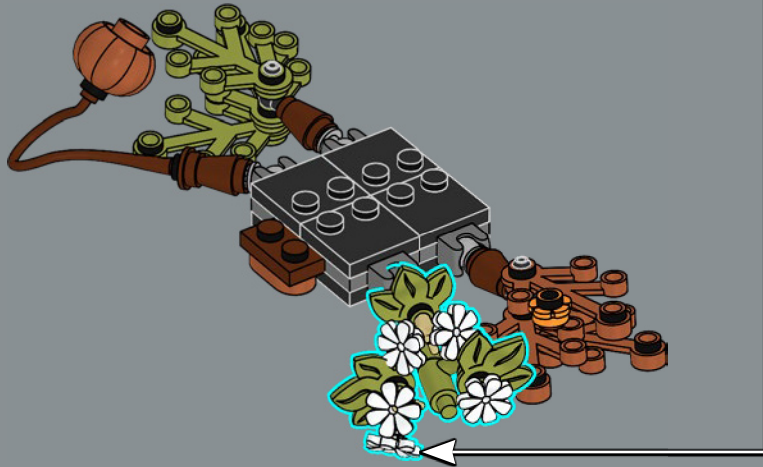

131

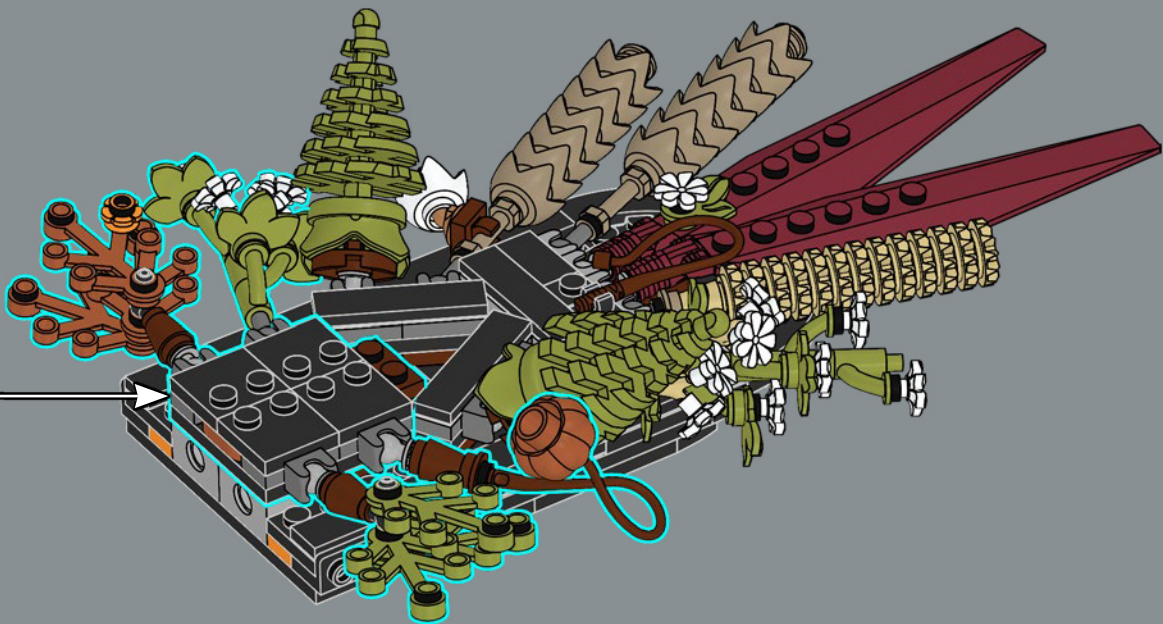

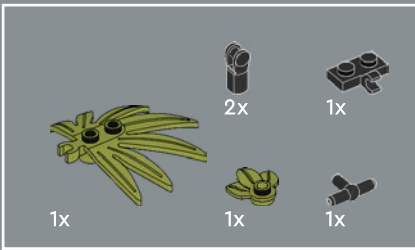

132

1

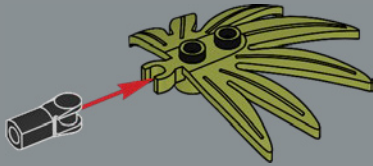

2

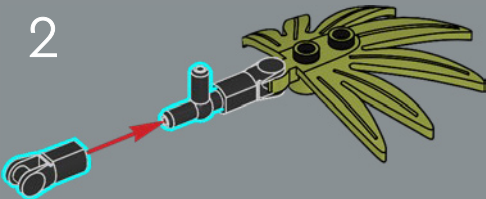

3

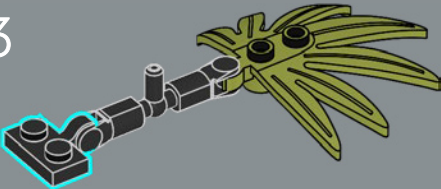

4

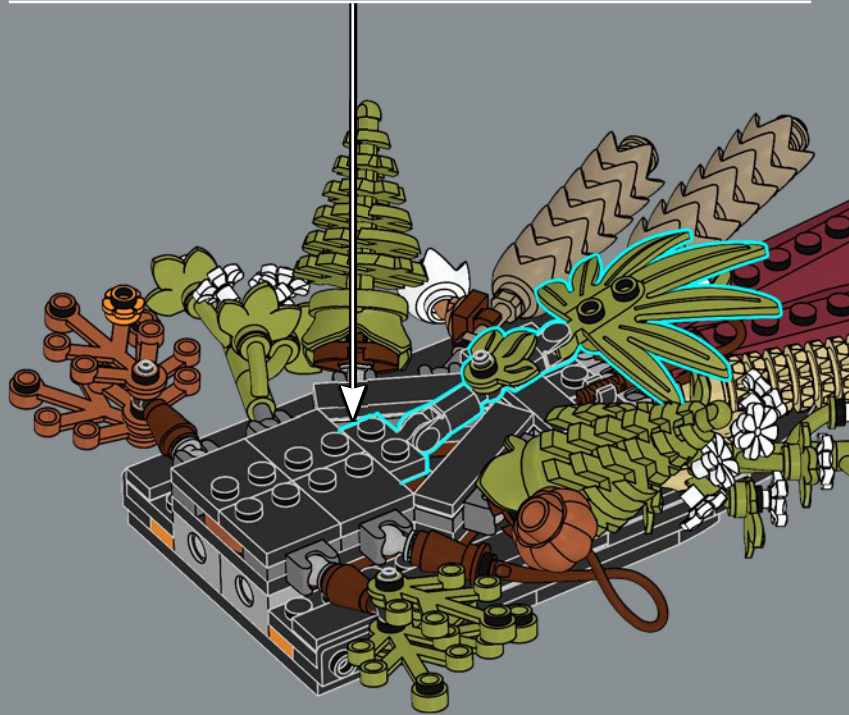
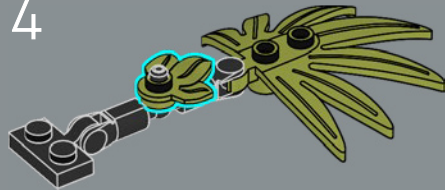

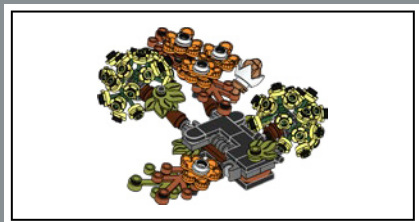

133

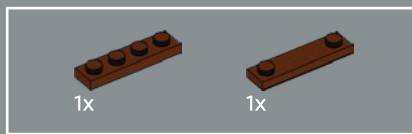
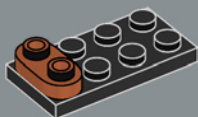

134

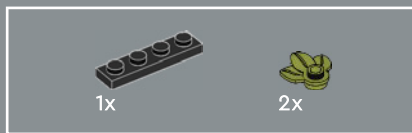
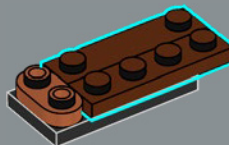

135

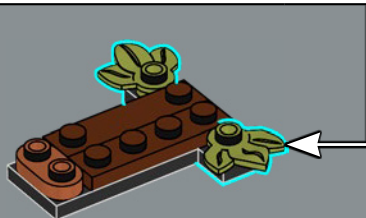
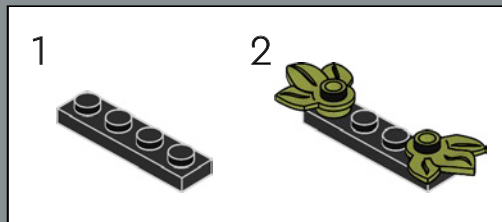

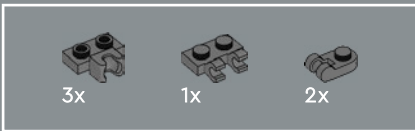

136

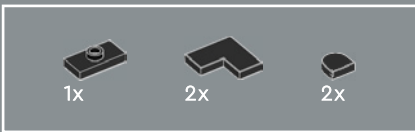
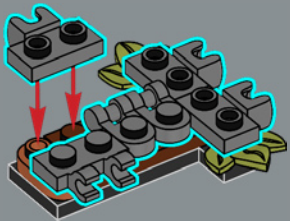

137

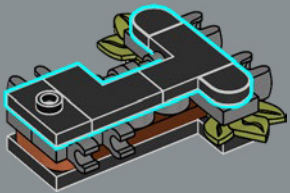

138

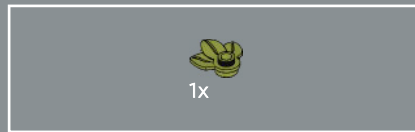
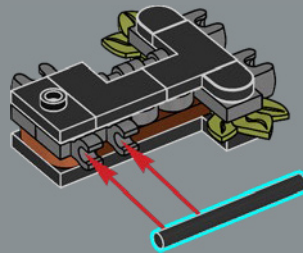

139

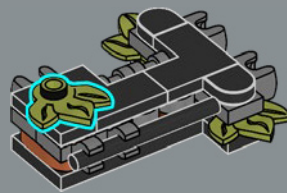

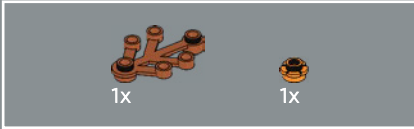

140

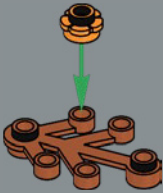

141

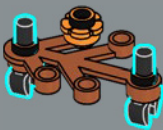

142

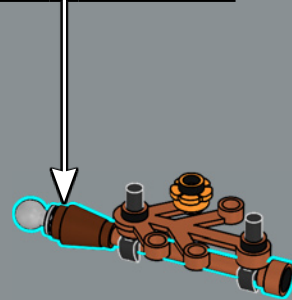
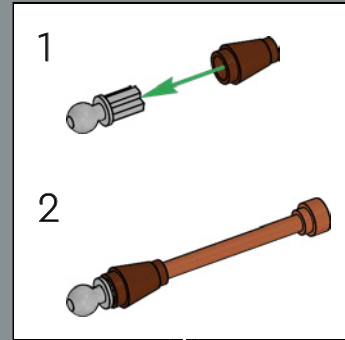

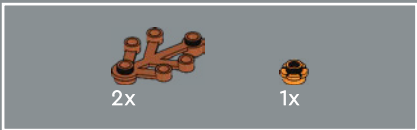

143

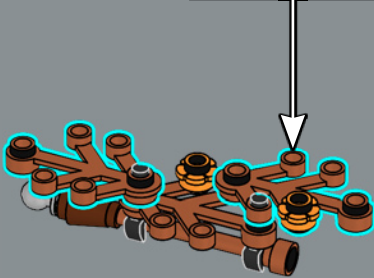
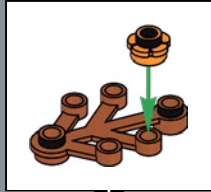

144

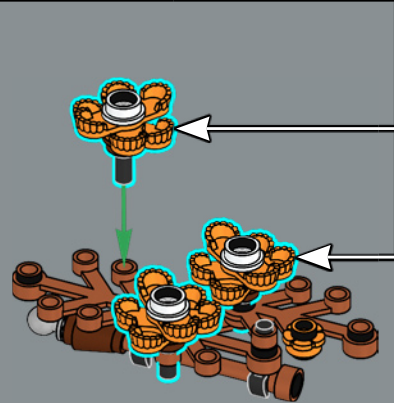
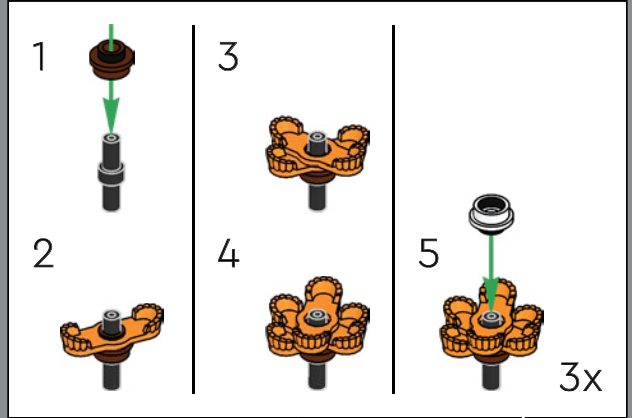



145

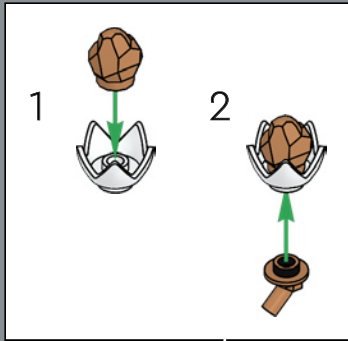

The dried daisy heads are constructed with a white crown element and a rare rock element first used as a gold nugget.

146

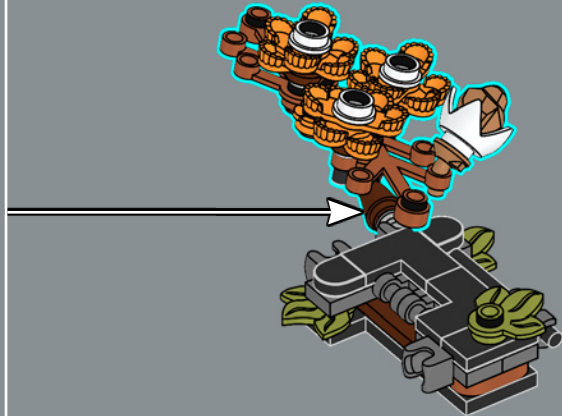

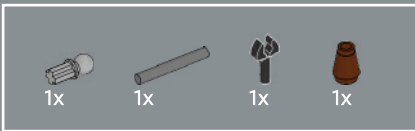

147

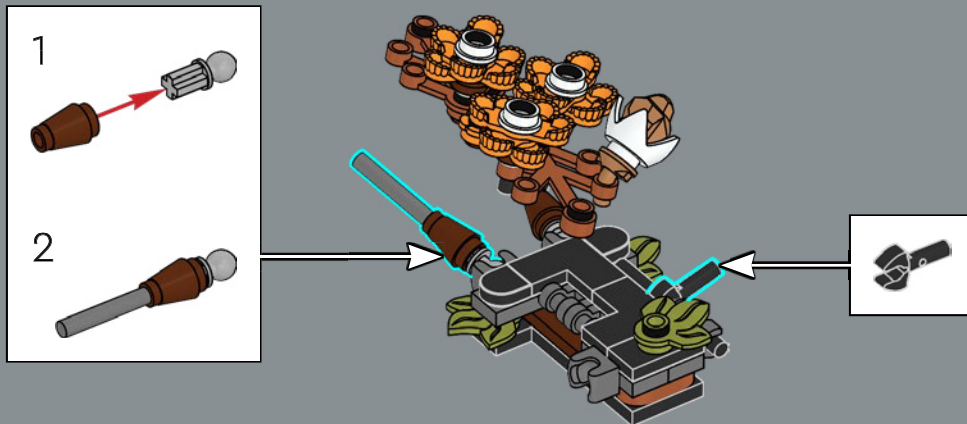



148

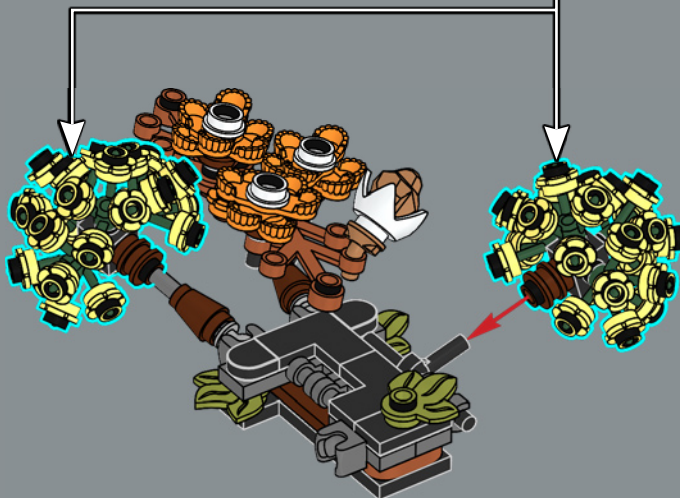
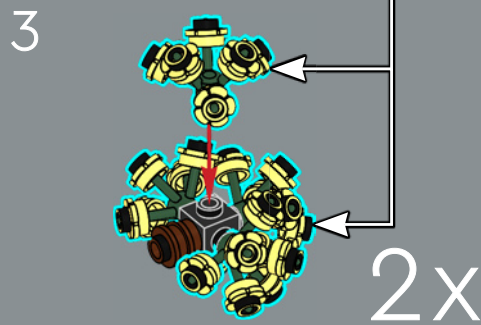
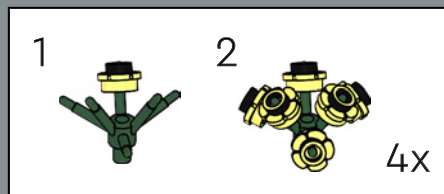
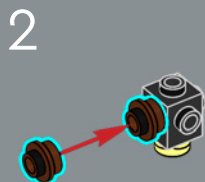
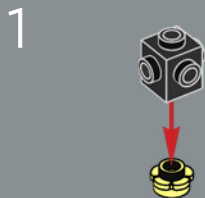



1x



2x

149

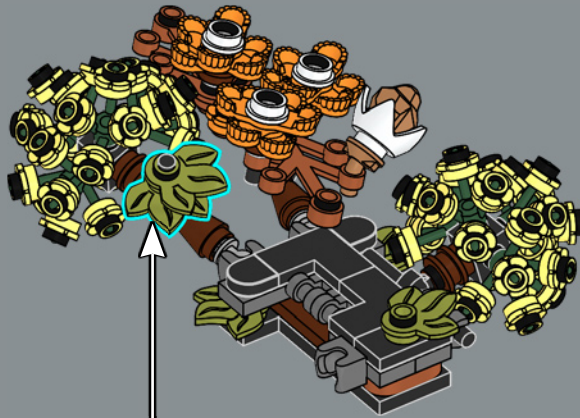

1

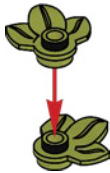

2





150

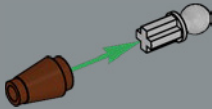

151

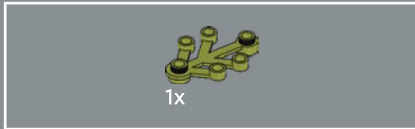
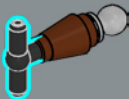

152

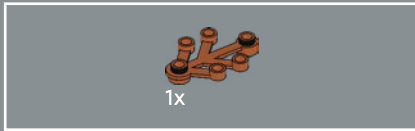

153





154

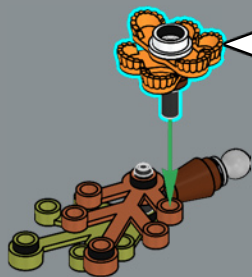
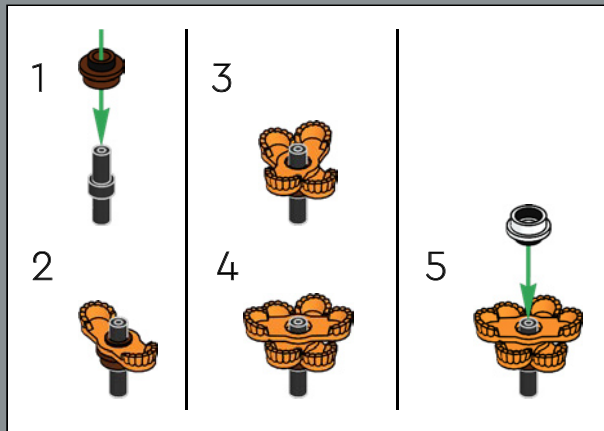

155

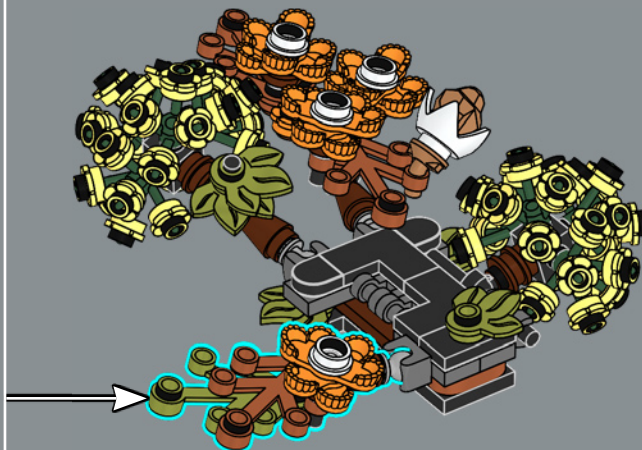

156

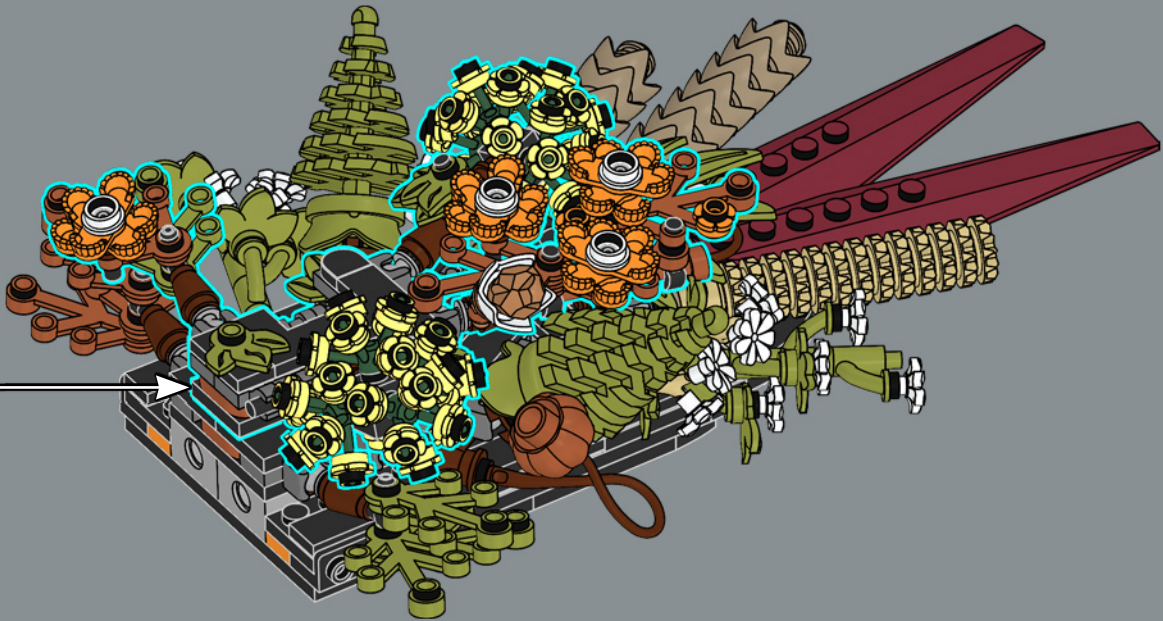

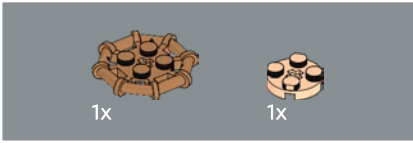
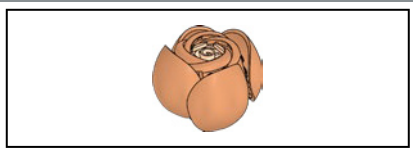

157

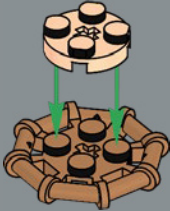

158



159

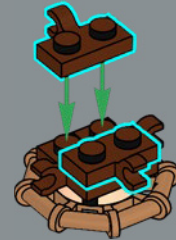

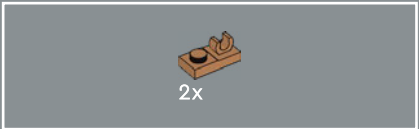

160

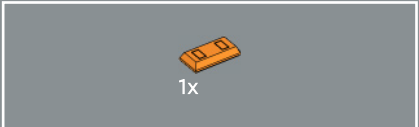

161

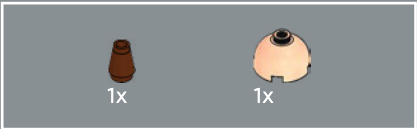

162

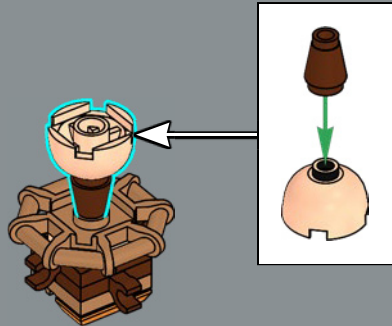

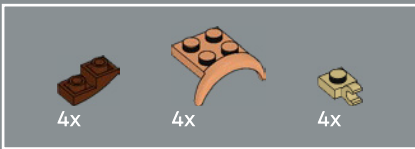

163

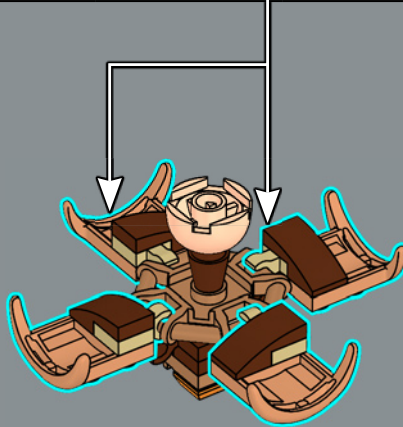
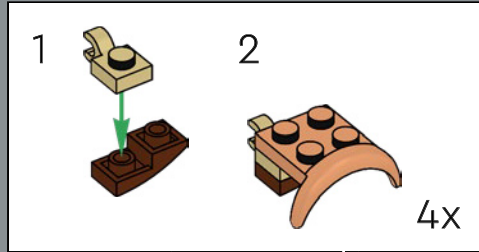

164

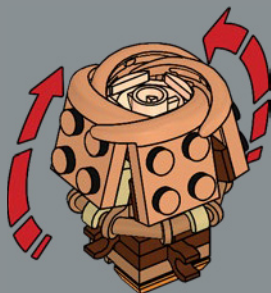

165

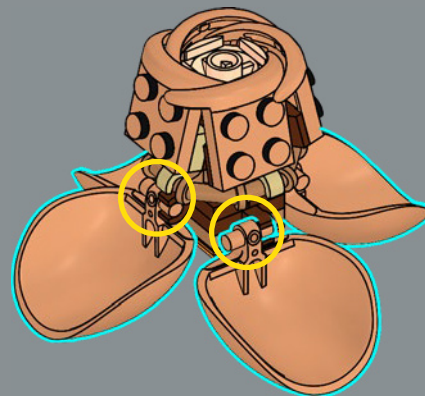
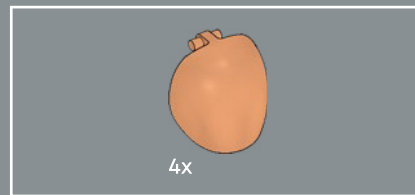

166

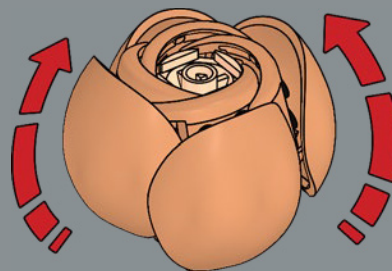



The intricate rose construction uses new mud guard elements for the inner petals and a new shell element for the outer petals.

167

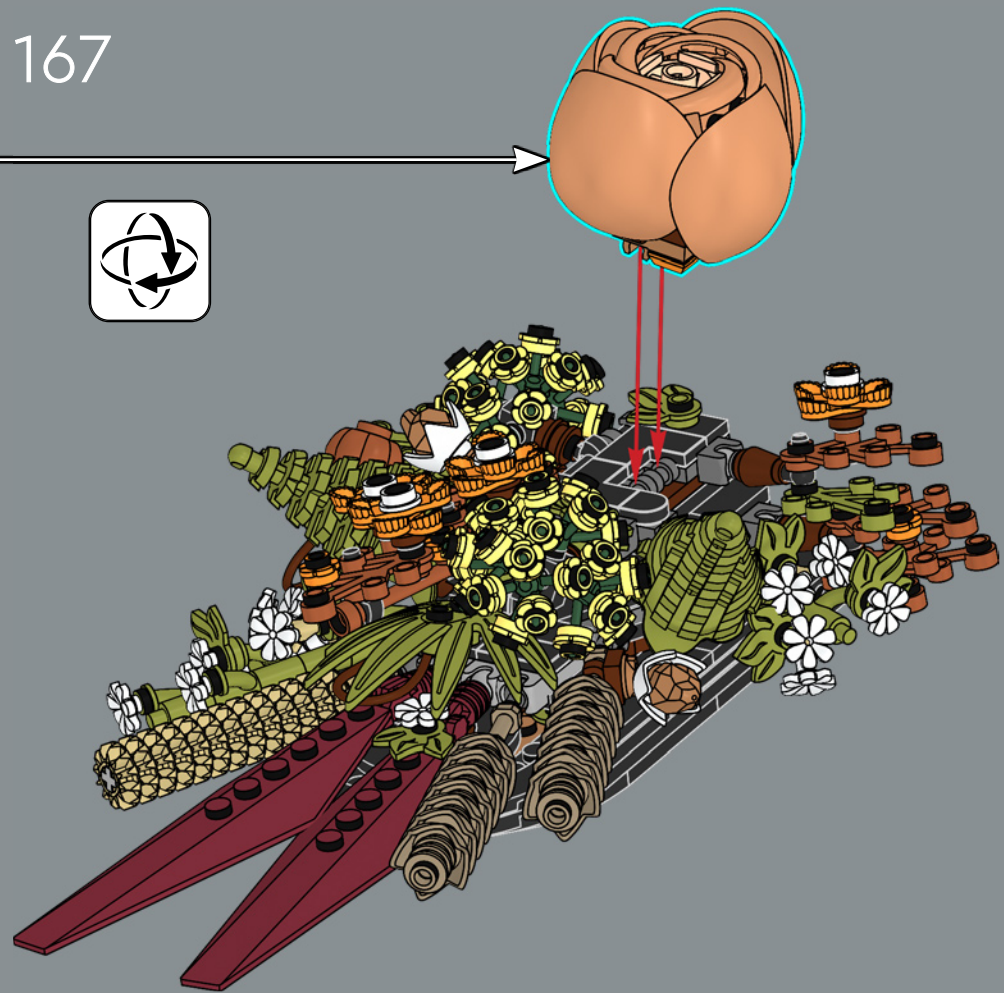



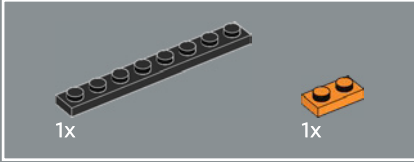
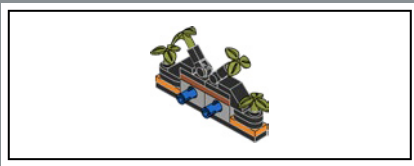

168

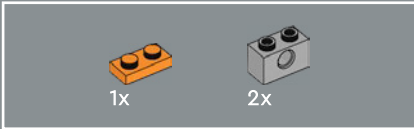
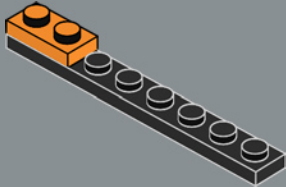

169

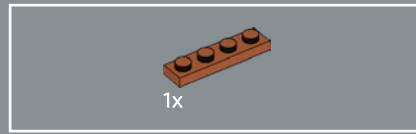
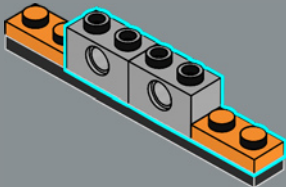

170

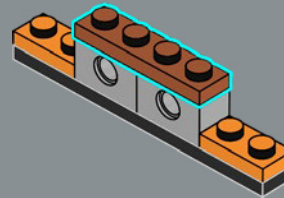

171

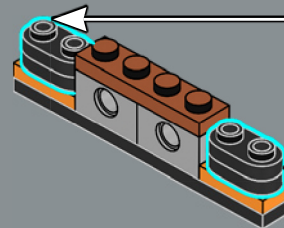
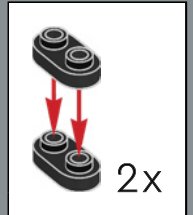



172

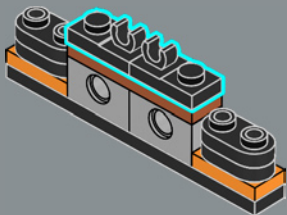

173

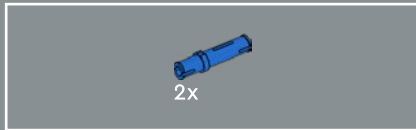
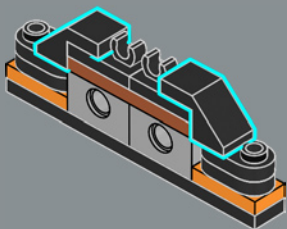

174

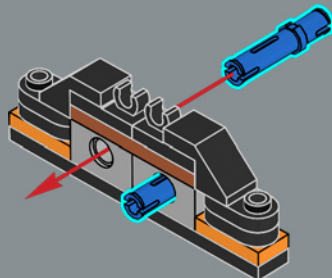



175

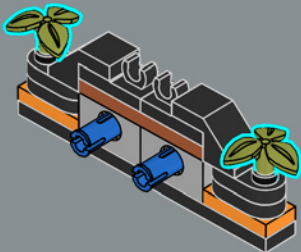

176

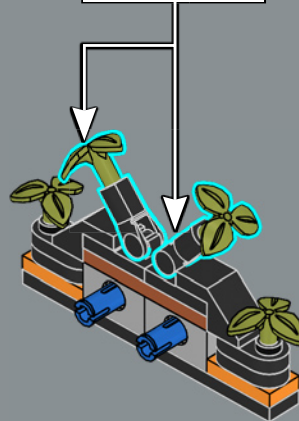
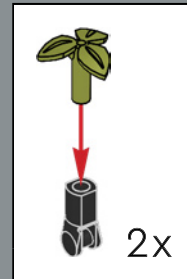

177

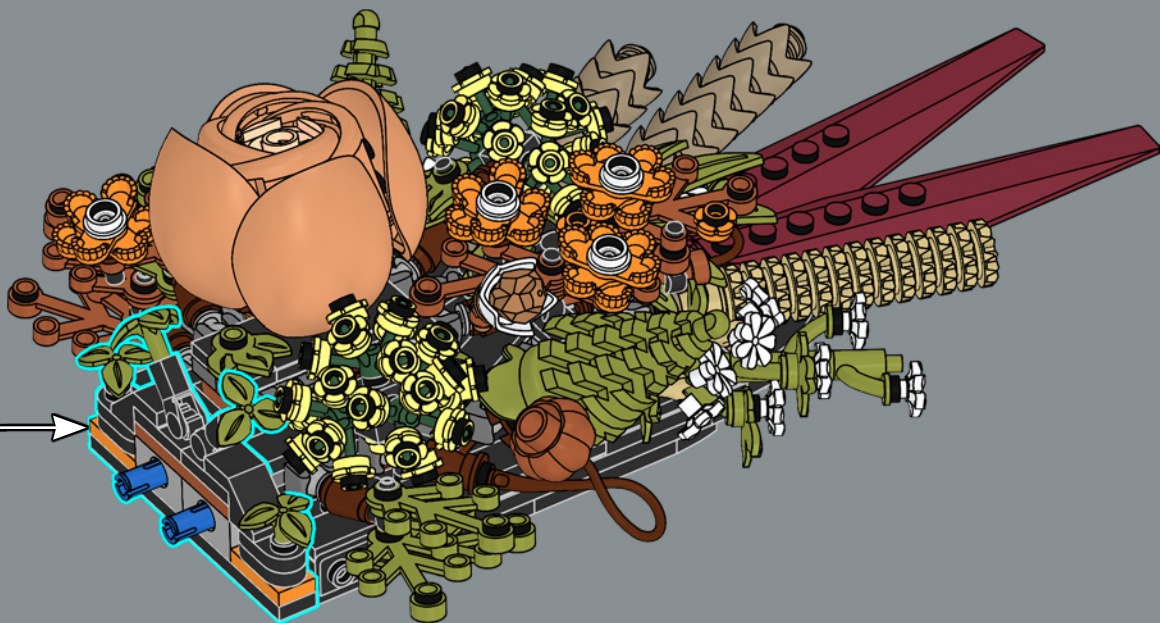



Dried flowers are sometimes preserved using a thin wax. The shiny elements in this set were chosen to replicate that wax look.

178

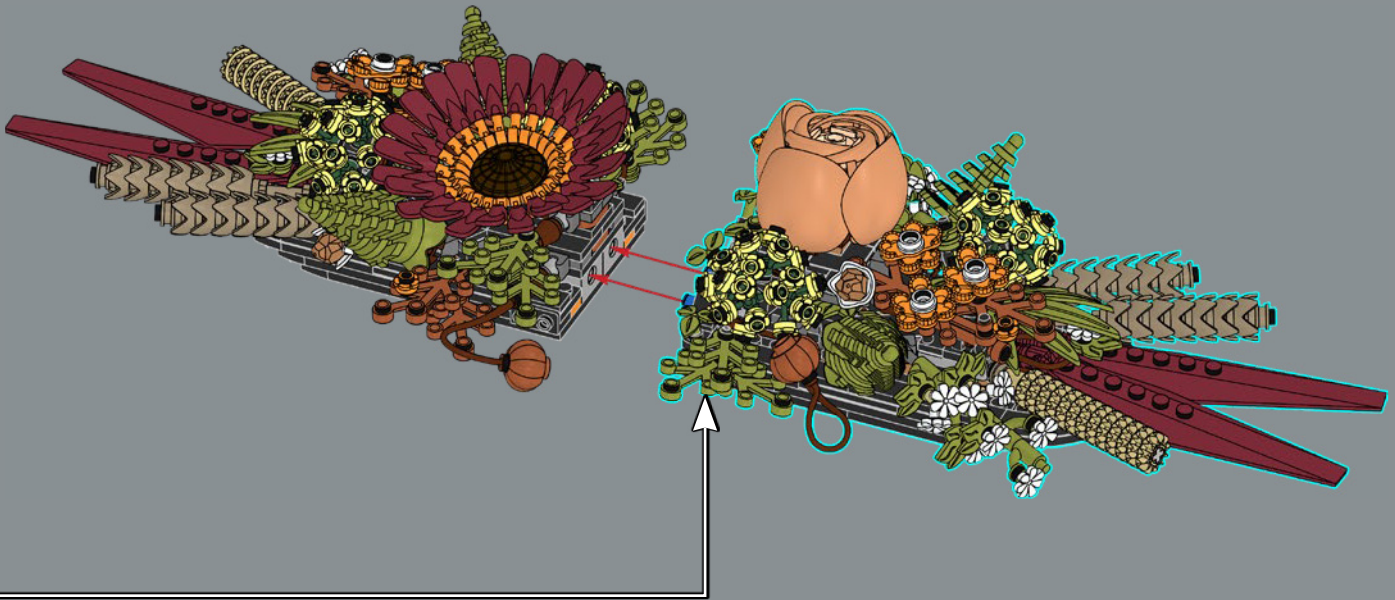

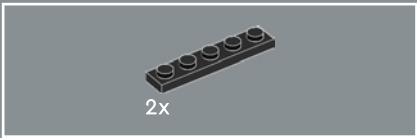

179

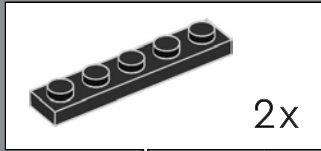

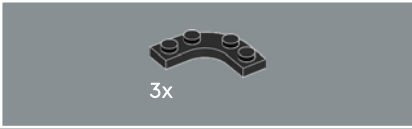
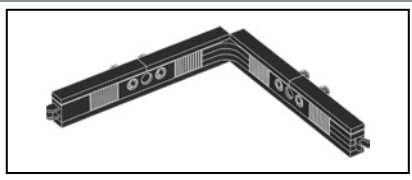

180

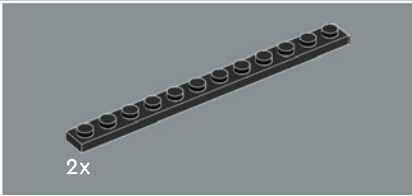
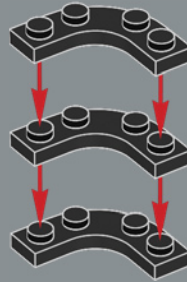

181

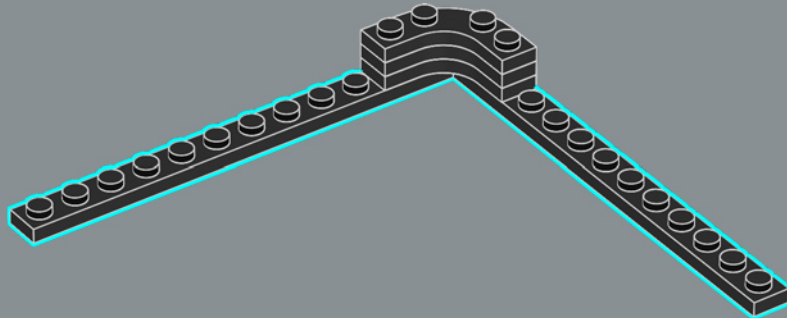

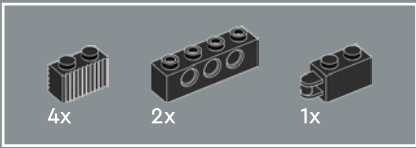

182

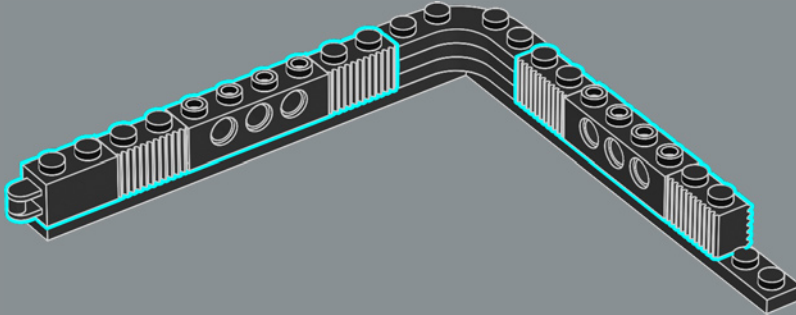

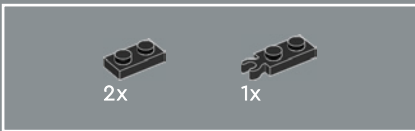

183

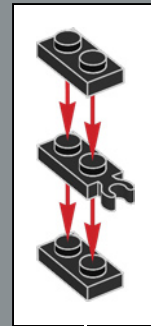
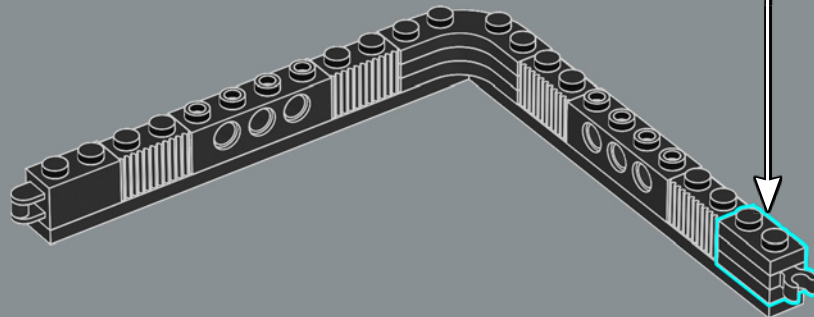

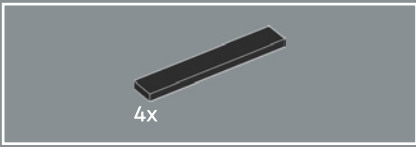

184

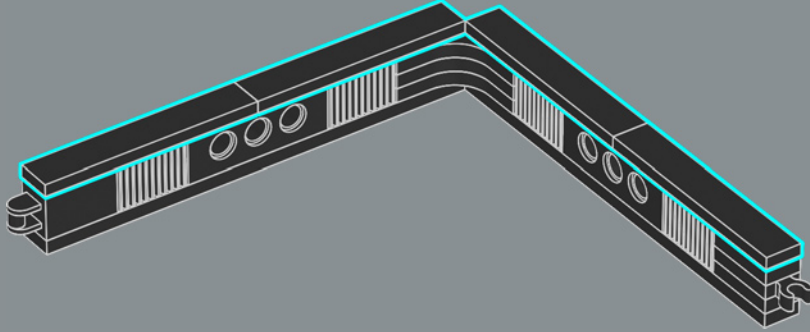

185

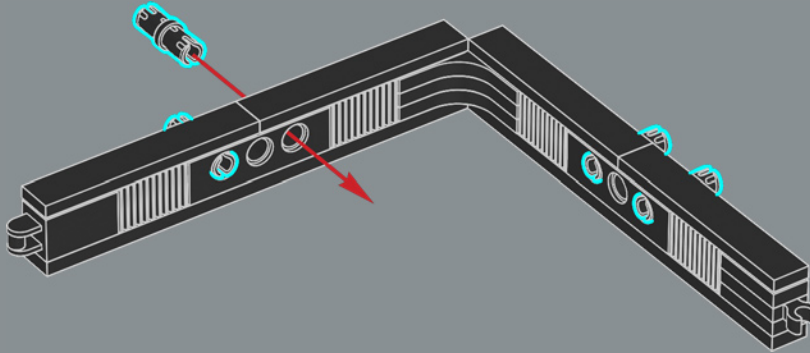

186

