



# CREATOR™

# 3 IN 1

## 31134



3 in 1  
3 en 1

3 em 1  
3 合 1

3 w 1  
3 v 1



3 az 1-ben  
3 in 1

"3 в 1"  
Kolm ühes

3 viename



 **FR**  
**DONNEZ**  
OU  
**RECYCLEZ**

 OU  OU 

ASSOCIATION MAGASIN DÉCHÈTERIE

Adresses sur [quefairedemesdechets.fr](http://quefairedemesdechets.fr)



[LEGO.com/sustainable-packaging](https://LEGO.com/sustainable-packaging)

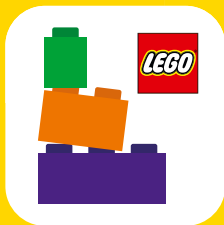

# BUILDER



Apple and the Apple logo are trademarks of Apple Inc., registered in the U.S. and other countries and regions. App Store is a service mark of Apple Inc. Google Play and the Google Play logo are trademarks of Google LLC. Tencent and the Tencent logo are trademarks of Tencent Inc.

 [LEGO.com/devicecheck](https://LEGO.com/devicecheck)

**EN** Ask parents' permission before going online | **DE** Eltern um Erlaubnis bitten, bevor du online gehst | **FR** Demande l'autorisation d'un parent avant d'aller en ligne | **IT** Chiedi il permesso ai tuoi genitori prima di andare online | **ES** Pídeles permiso a tus papás antes de conectarte a Internet | **PT** Pede autorização aos pais antes de acederes online | **JA** オンラインになる前に ほご者の方のきよかをもらおう | **ZH** 上网前应先征得父母的同意 | **KO** 온라인 접속 전에 보호자 동의가 필요합니다 | **RU** Спроси разрешения у родителей, прежде чем заходить в интернет | **PL** Poproś rodziców o zgodę, zanim wejdiesz do Internetu | **CS** Než půjdeš na internet, požádej rodiče o svolení | **SK** Skôr než pôjdeš na internet, vypýtaj si povolenie od rodičov | **HU** Kérj szülői engedélyt, mielőtt online csatlakoznál! | **RO** Cere permisiunea părinților înainte de a te conecta online | **BG** Поискайте разрешение от родители, преди да влезете онлайн | **LV** Pirms došanās tiešsaistē palūdz atļauju vecākiem | **ET** Enne Interneti kasutamist küsi vanematelt luba | **LT** Prieš prisijungdami prie interneto, atsiklauskite tėvų







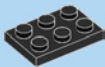

1x



1x

1

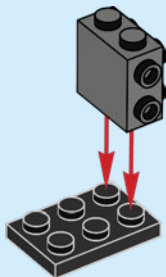



2x

2

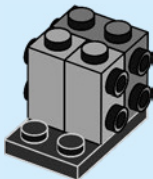



1x

3

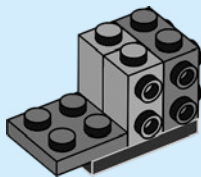

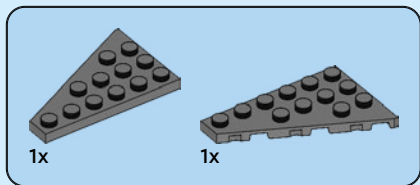

4

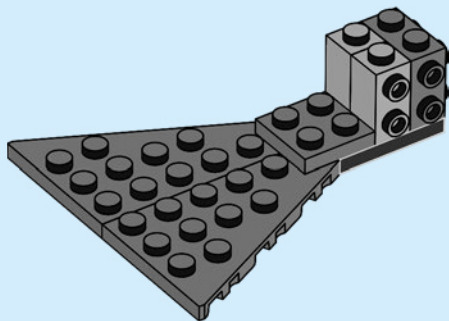



2x

5

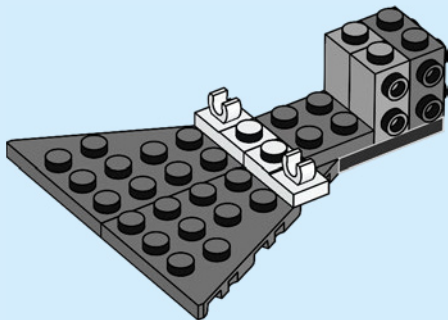

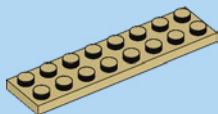

1x

6

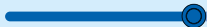
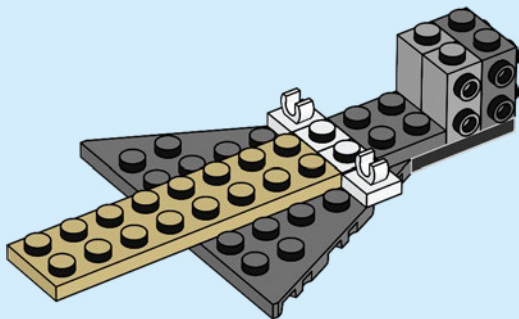



1x

7

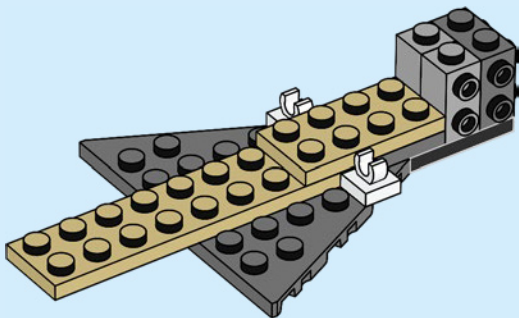



1x



2x

8

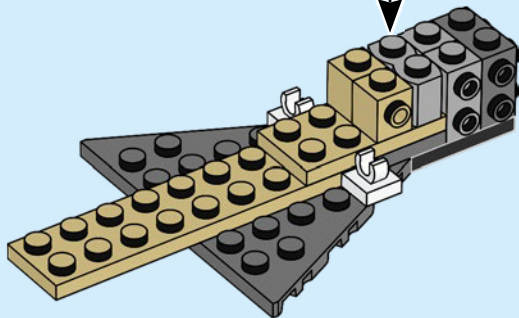
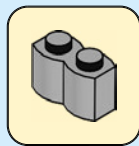





2x

9

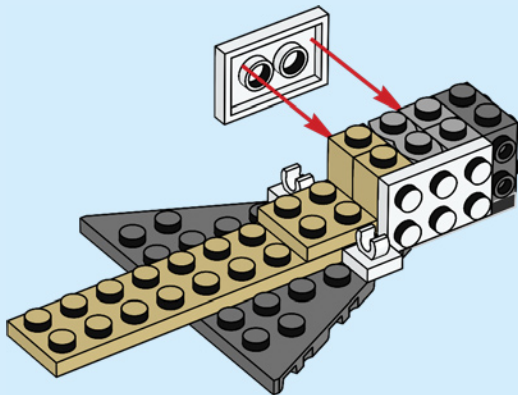



2x



2x

10

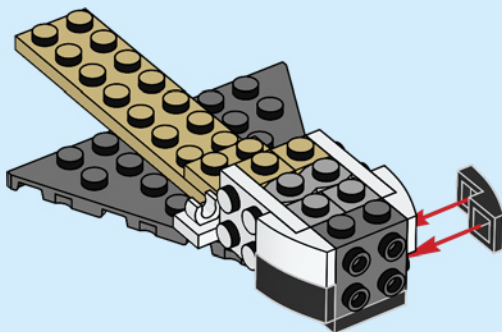



2x

11

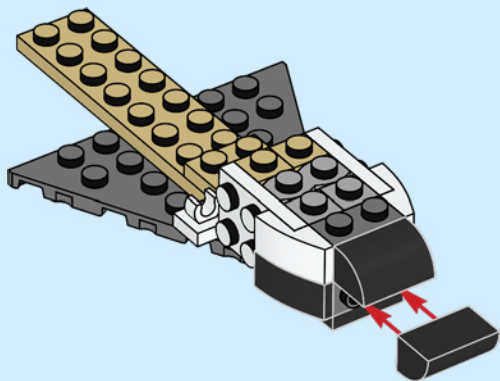

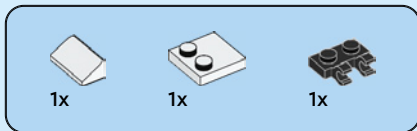

12

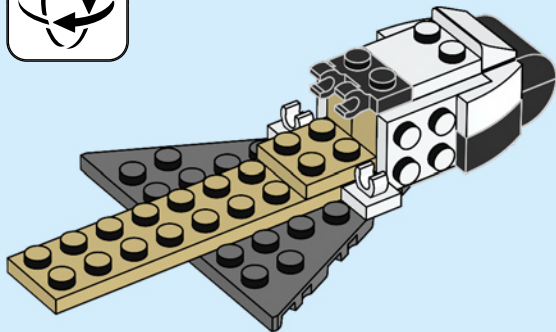
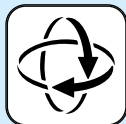



2x

13

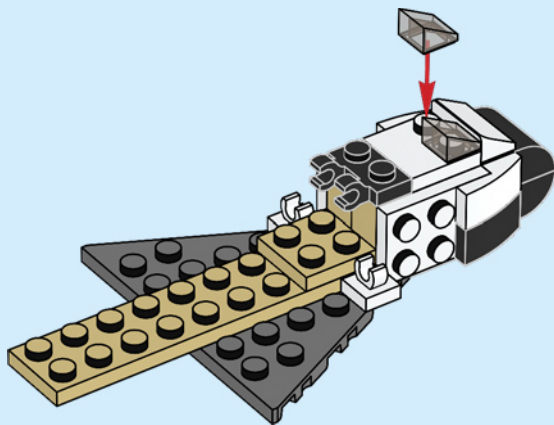

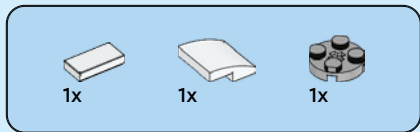

14

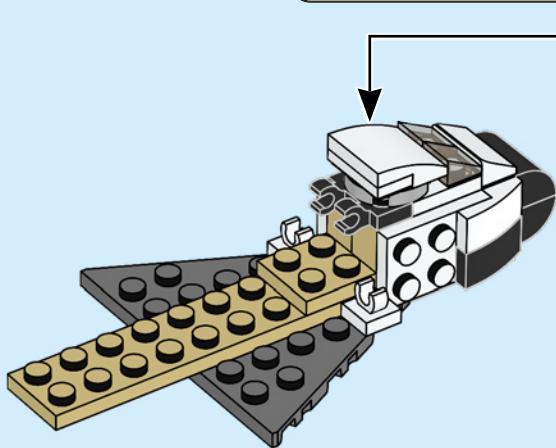
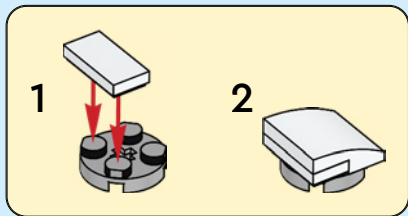



2x



2x

15

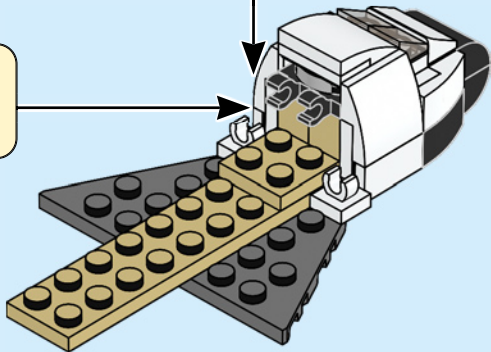
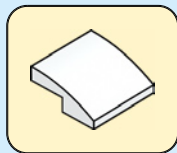



1x



1x

# 16

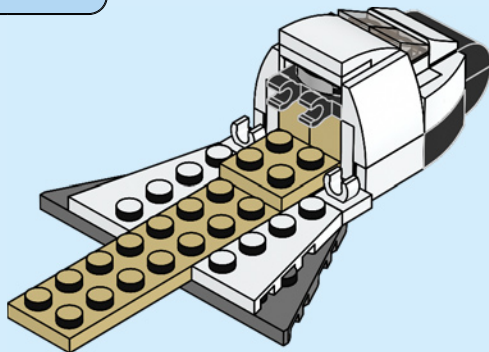



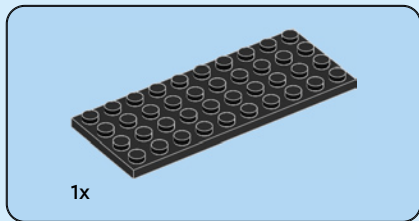

17

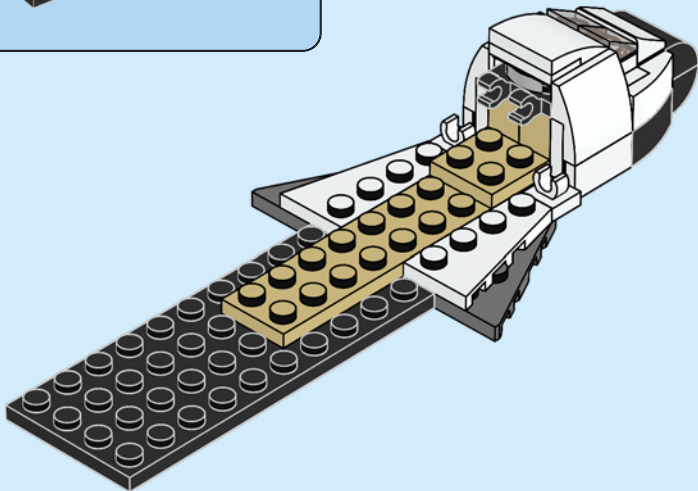



2x

18

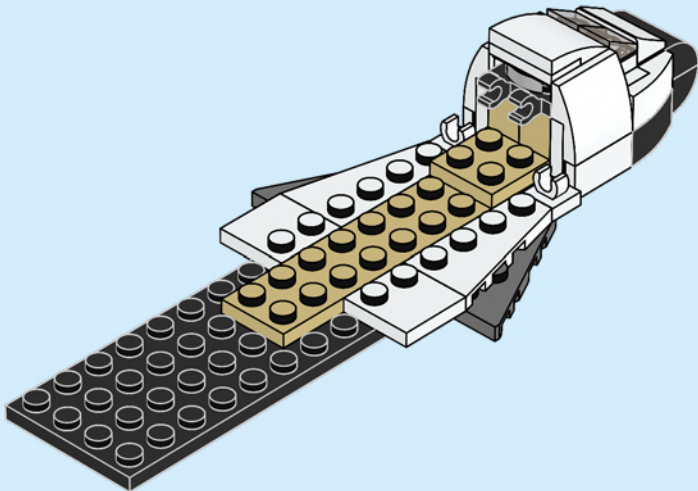



4x

19

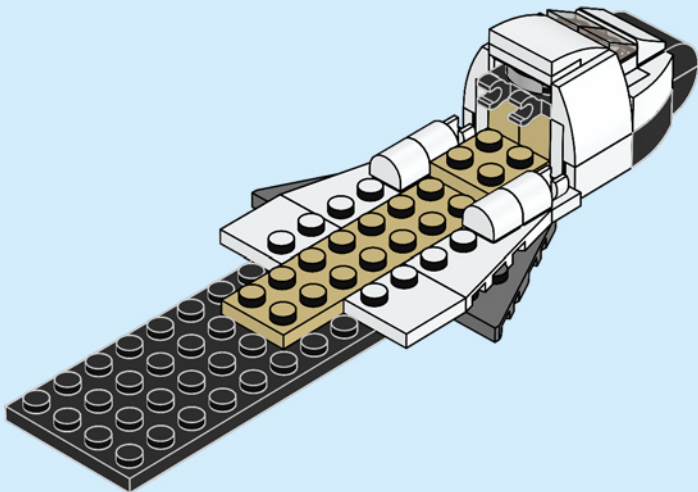



2x

20

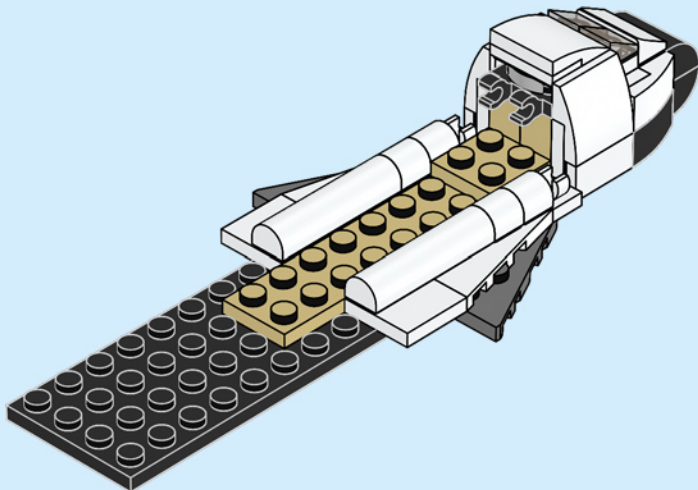

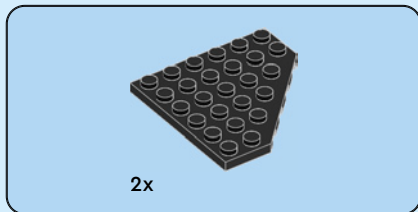

21

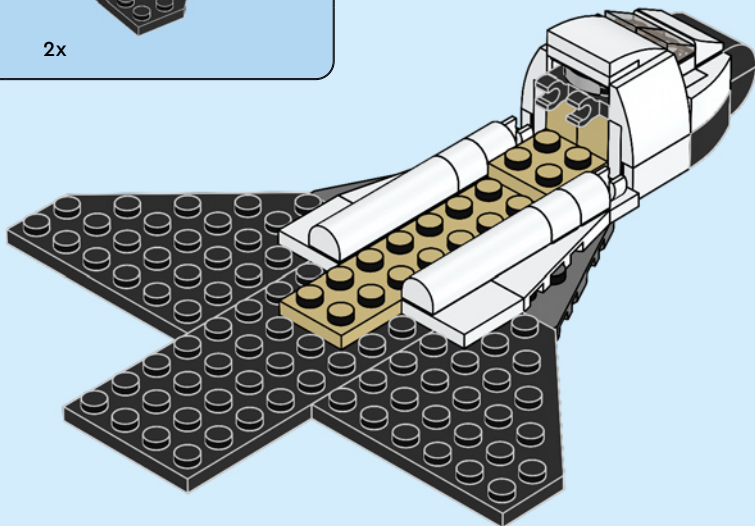



2x

22

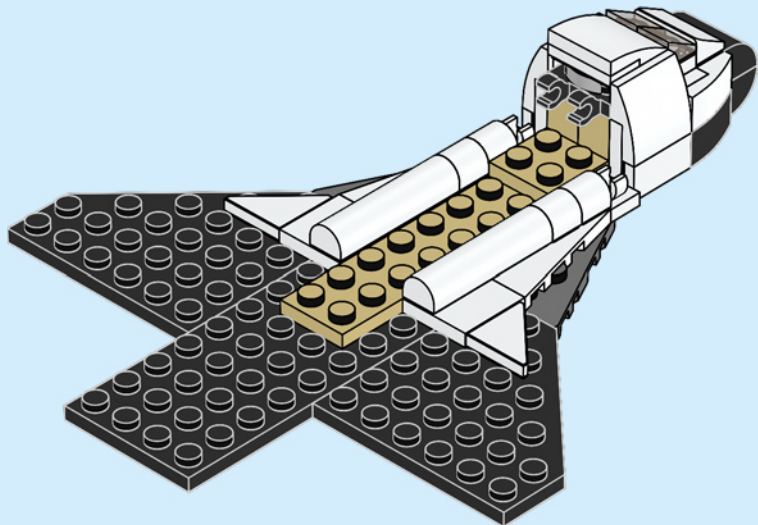



2x



2x

# 23

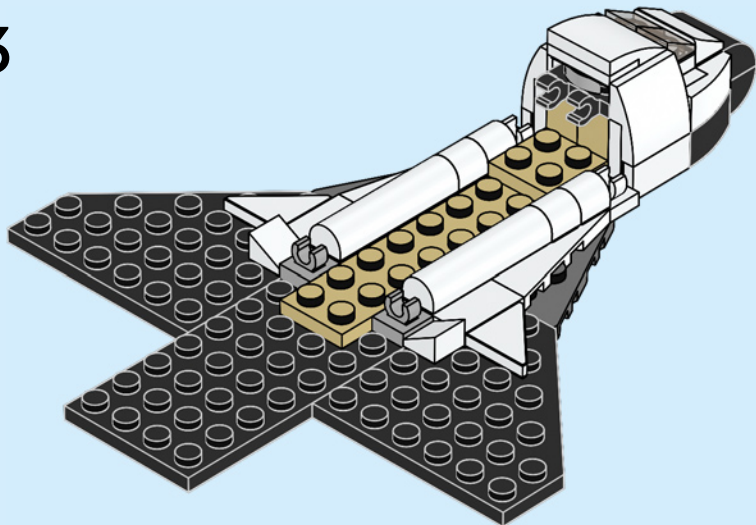



2x



2x

# 24

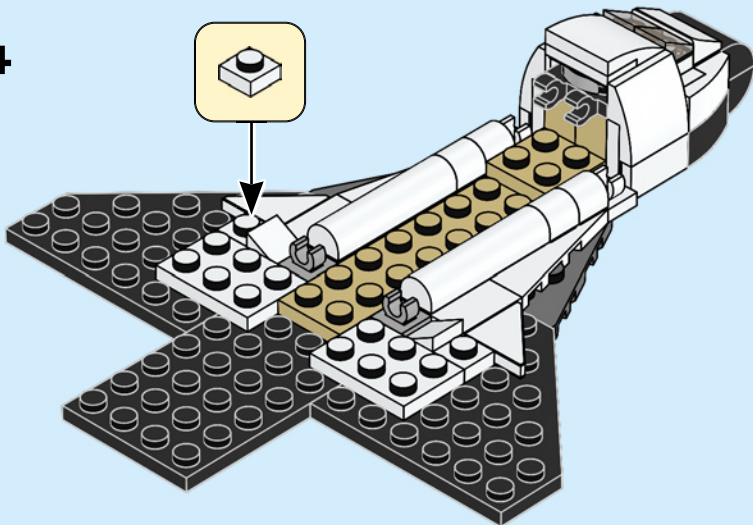





1x



2x

# 25

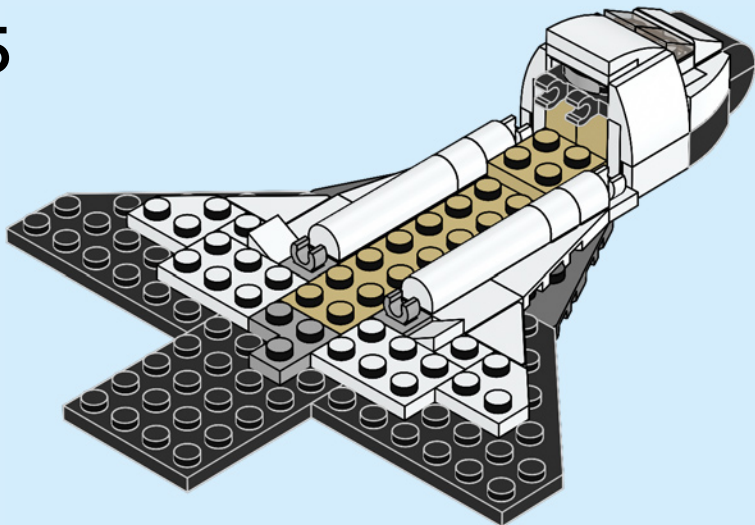



2x



2x



2x



1x

# 26

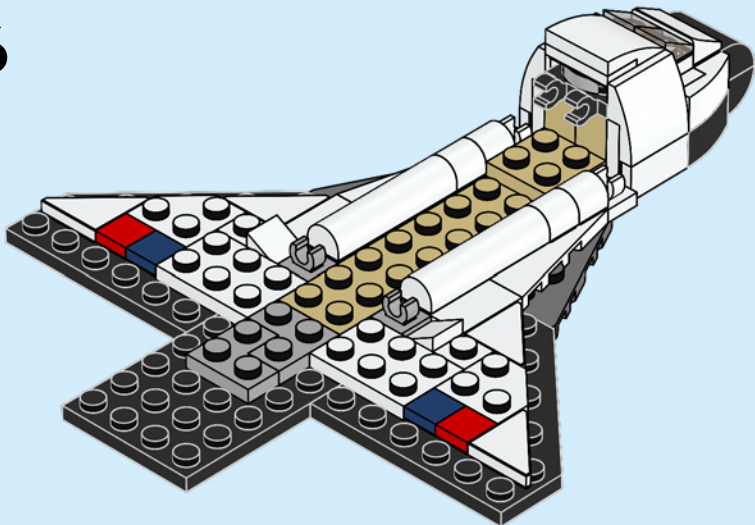

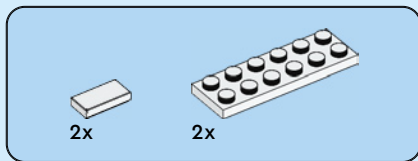

27

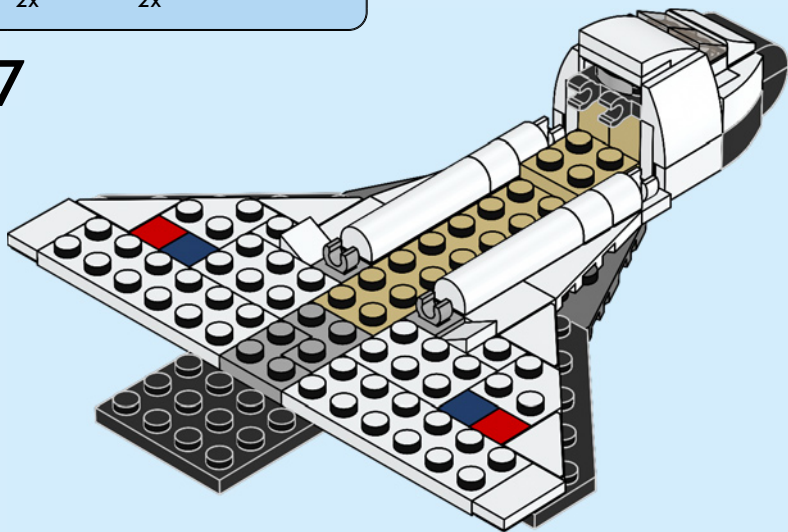

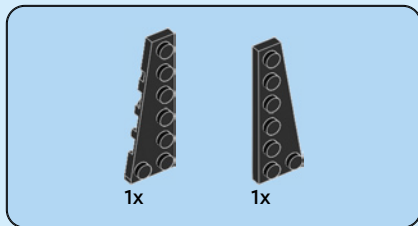

28

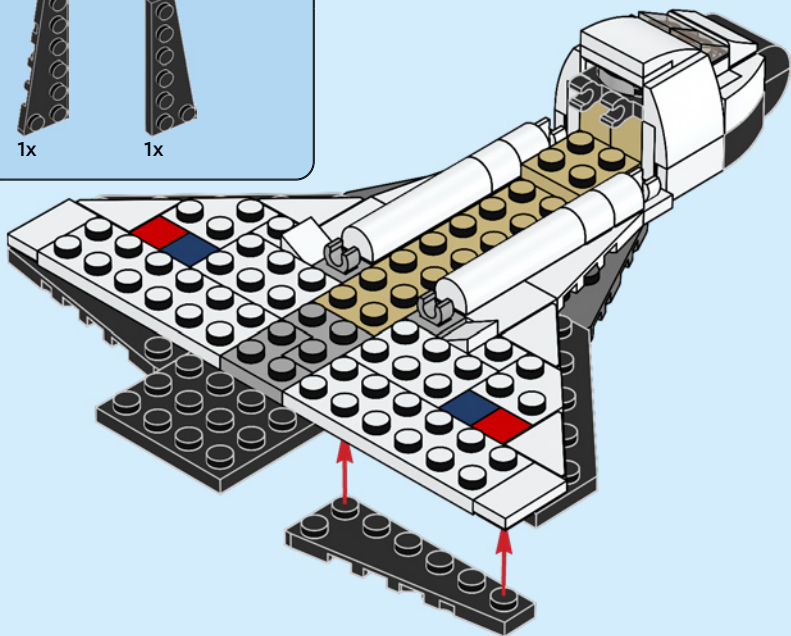



1x

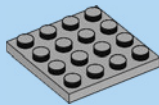

1x

# 29

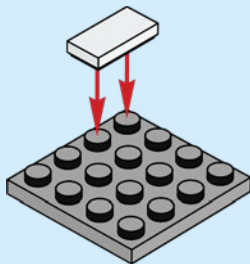

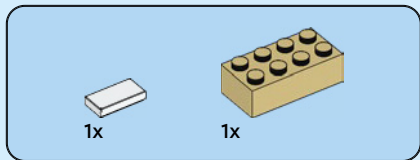

30

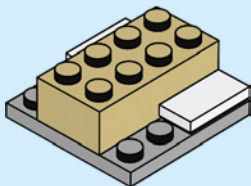



1x

31

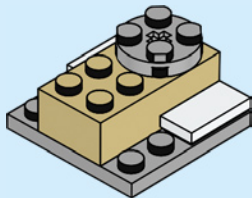



1x



1x

# 32

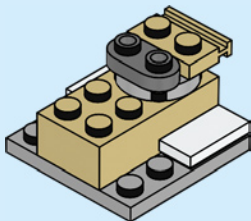





2x

33

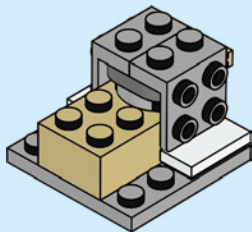



2x

34

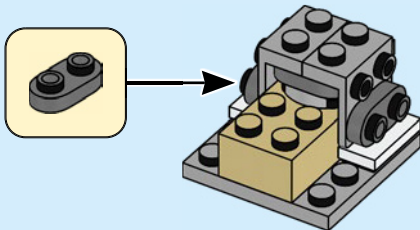



2x

# 35

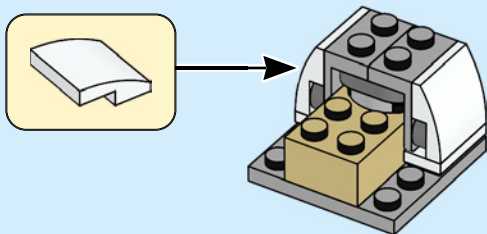



1x



1x

# 36

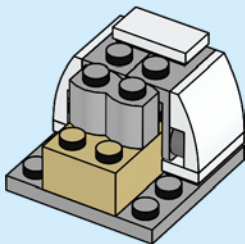



2x



2x

# 37



2x

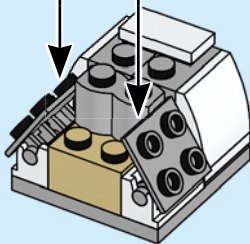

38

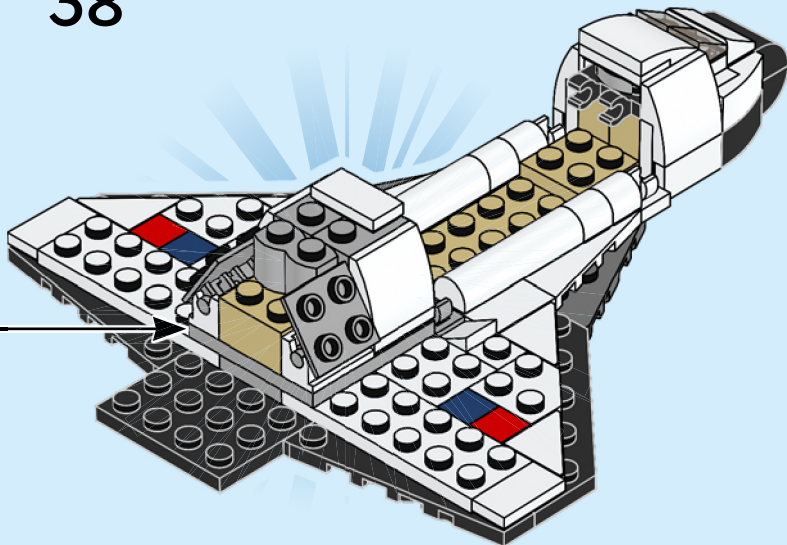

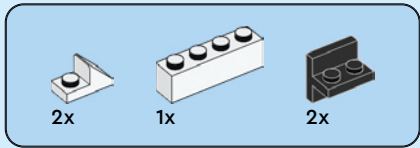

# 39

1

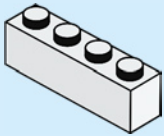

2

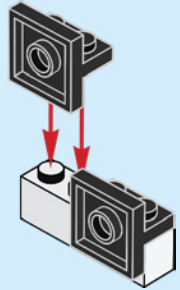

3

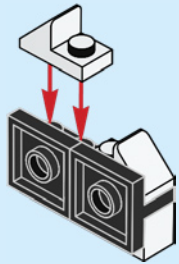

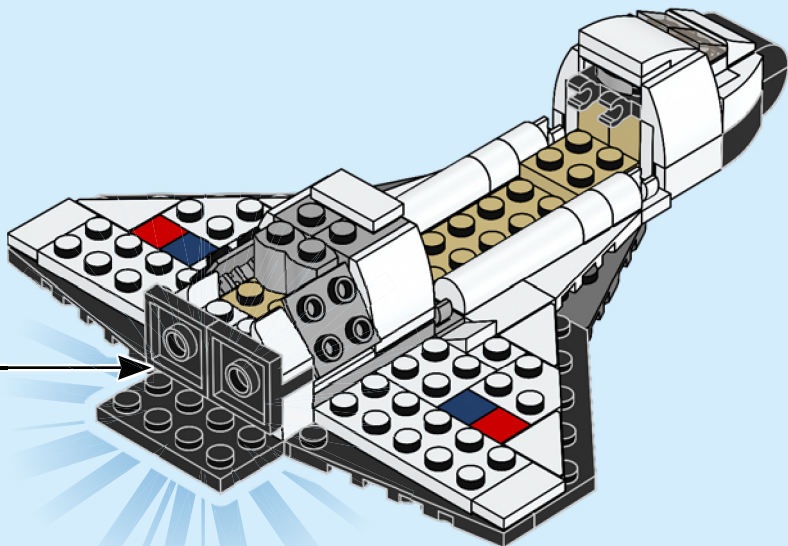





1x



1x



1x

# 40

1

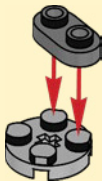

2

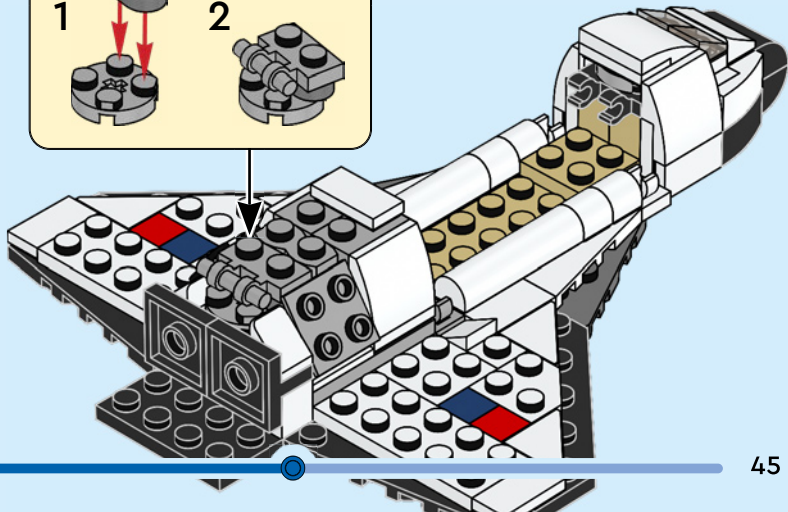



2x



2x

# 41

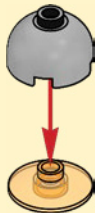

2x

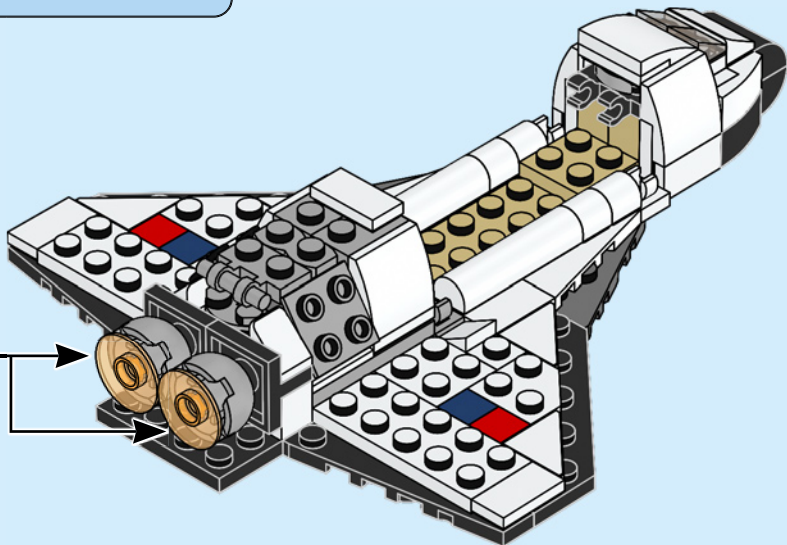



2x

42

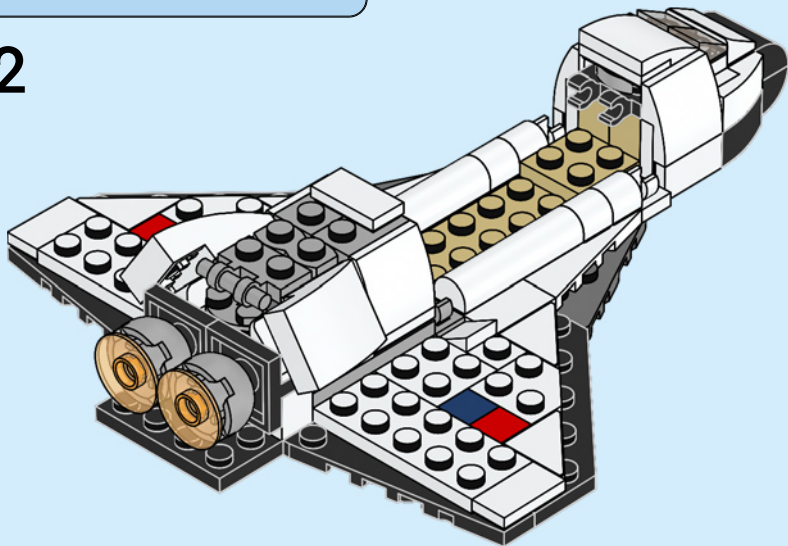

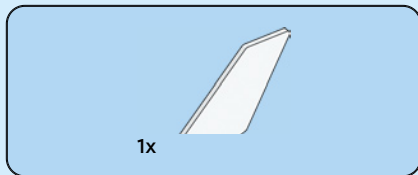

43

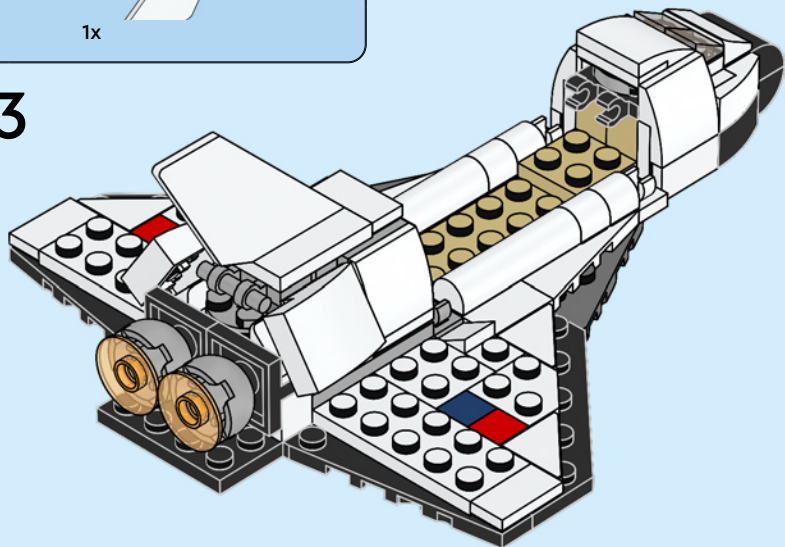



1x



1x



1x

# 44

1

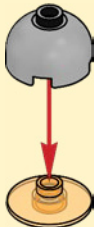

2

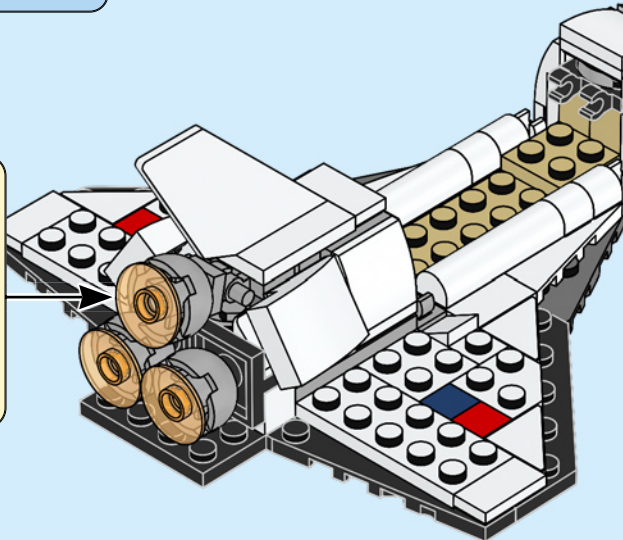



2x



1x



2x

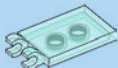

2x

45

1

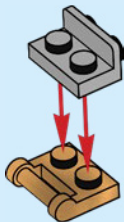

2

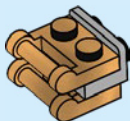

3

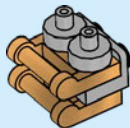

4

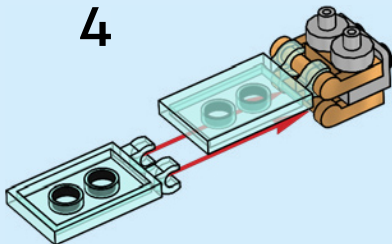

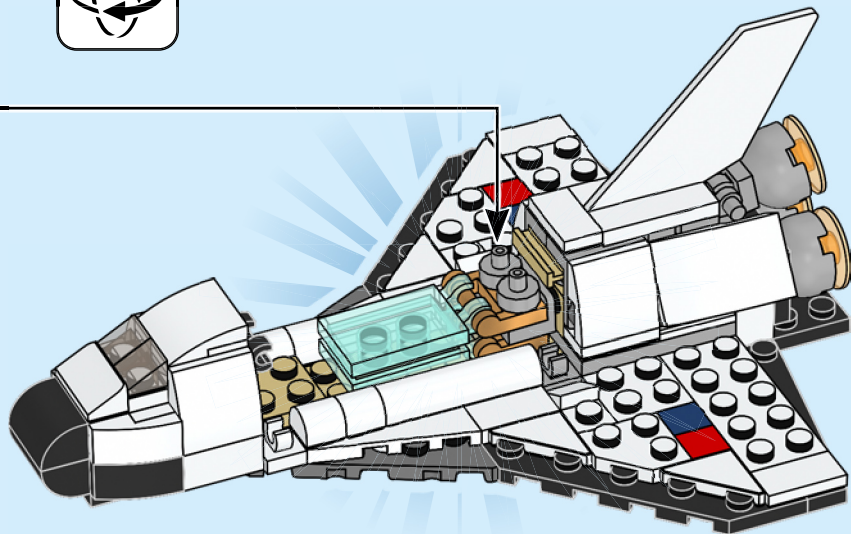
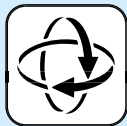

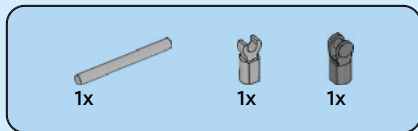

46

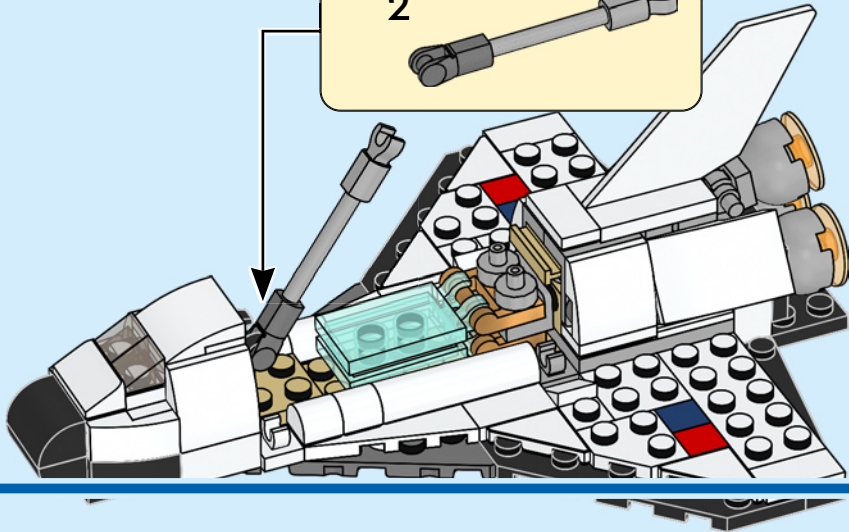
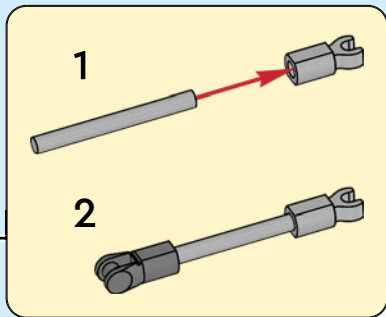



47

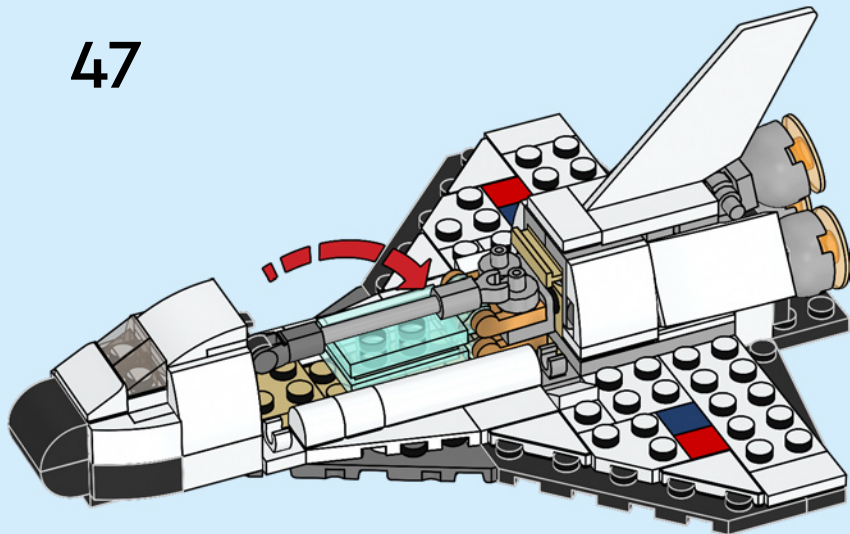



2x



2x



8x



2x



8x



4x

48

1

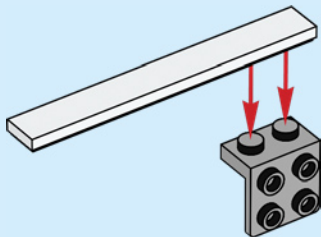

2

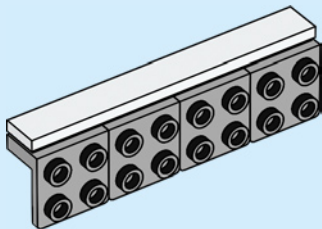

3

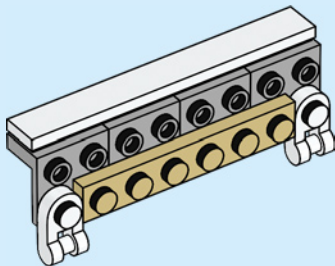

4

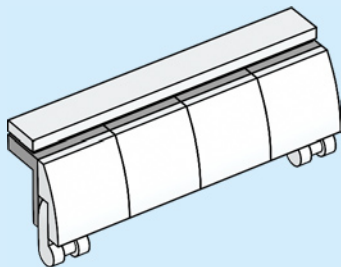

2x

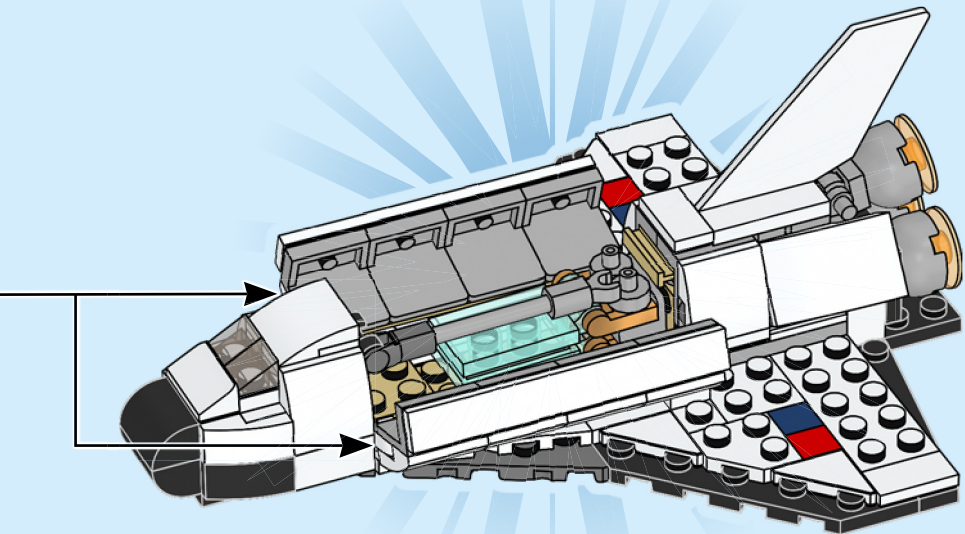

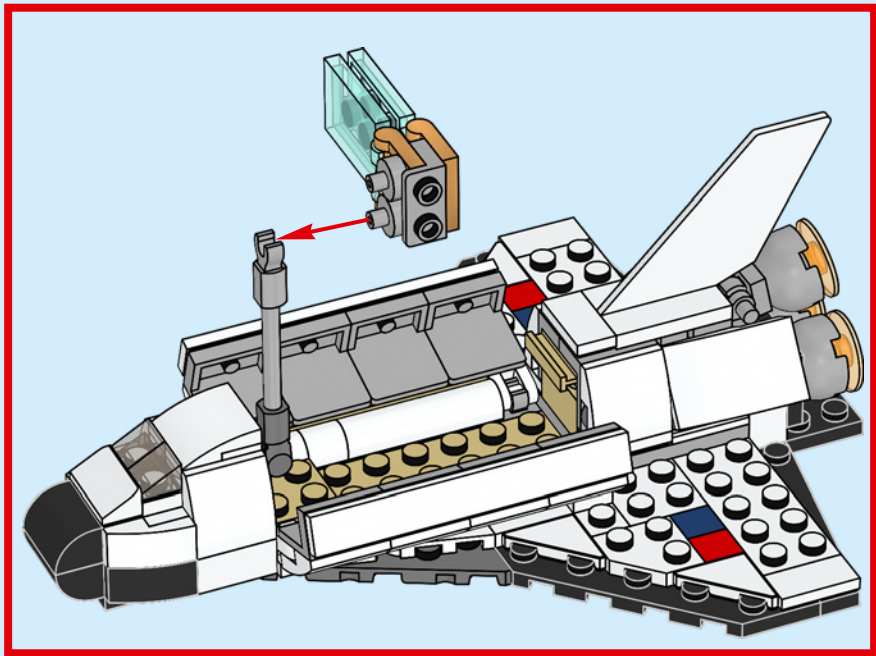

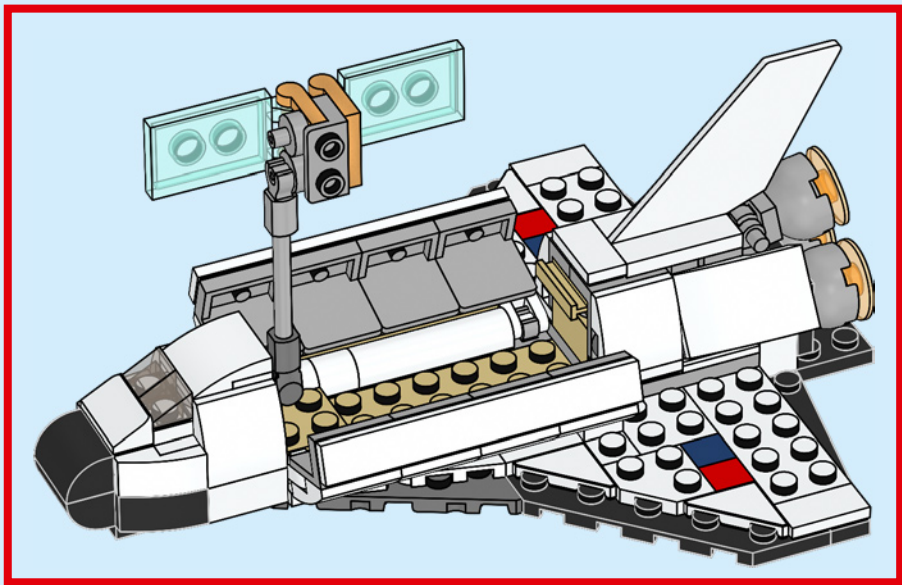

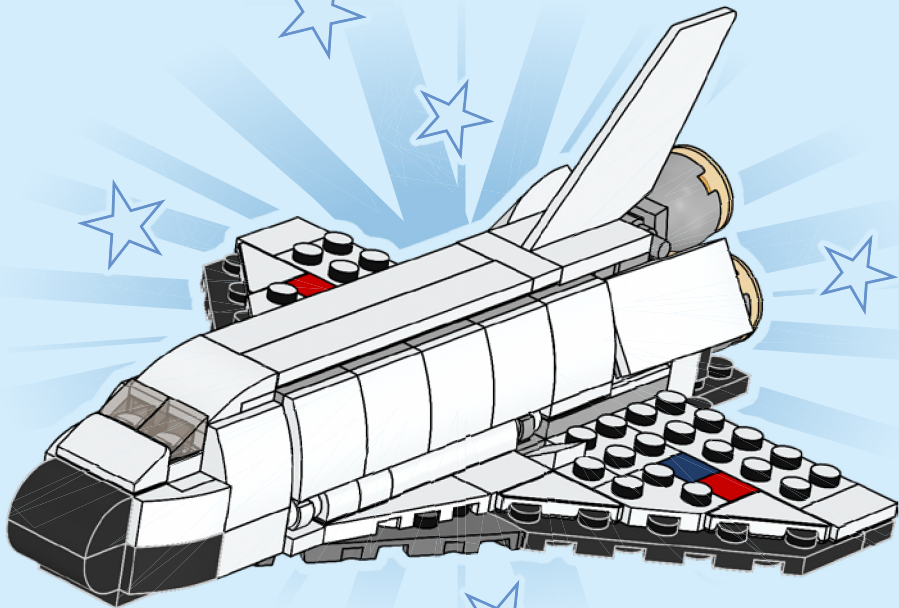





# CREATOR™

# 3 IN 1

## 31134

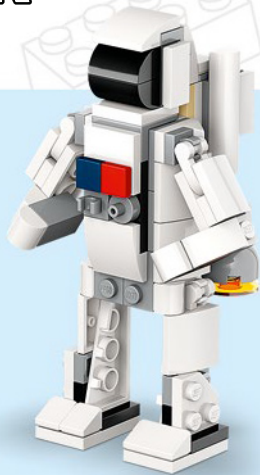

3 in 1  
3 en 1

3 em 1  
3 合 1

3 w 1  
3 v 1

3 az 1-ben  
3 in 1

„3 в 1“  
Kolm ühes

3 viename

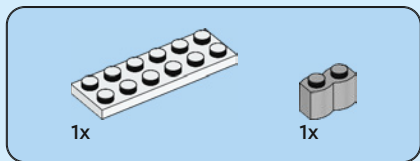

1

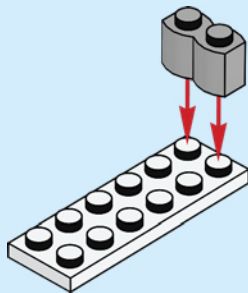

2



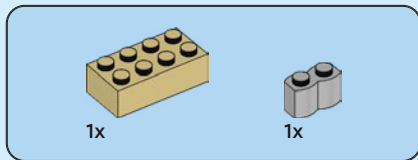

2

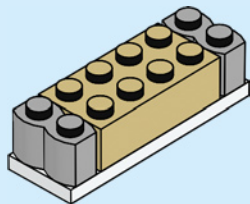



6x

3

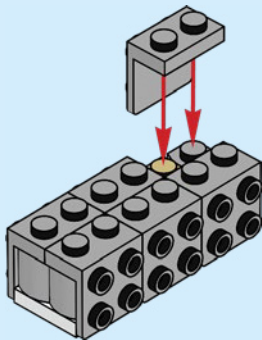

4



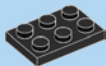

1x



1x

4

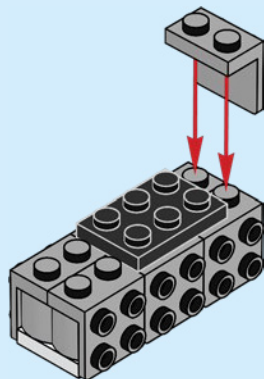



1x



1x



1x



1x

5

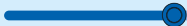
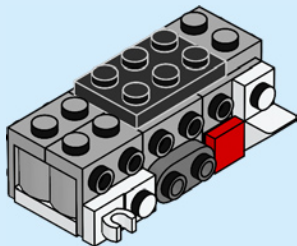



2x



1x



1x

6

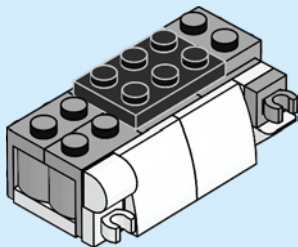

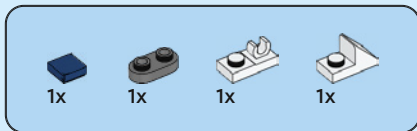

7

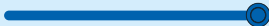
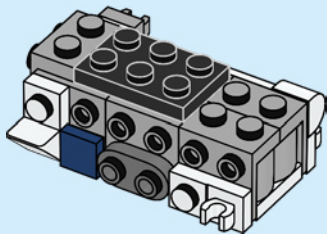





2x



1x



1x

8

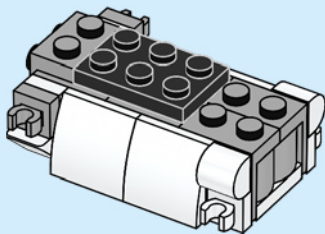

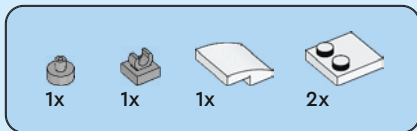

9

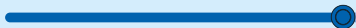
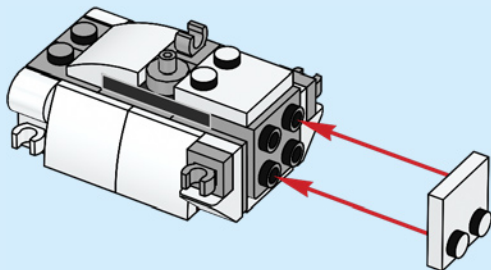



1x



1x

10

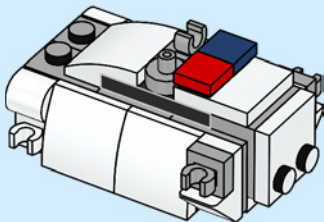



1x



3x



2x



1x



2x

# 11

# 1

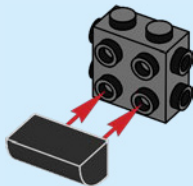

# 2

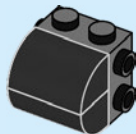

3

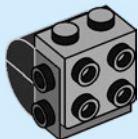

4

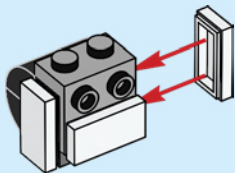

5

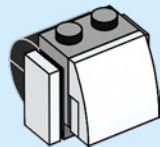

6

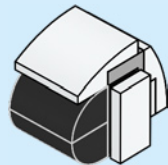

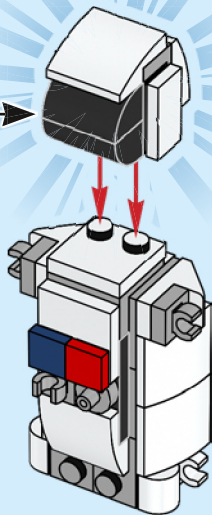
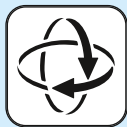



1x

12

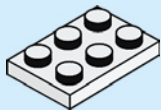



1x

13

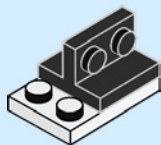

1x

14

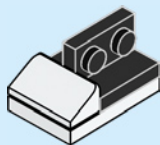



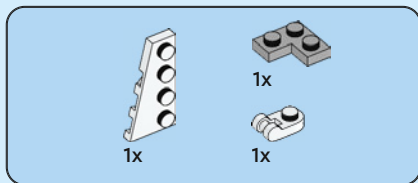

15

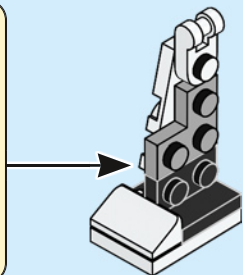
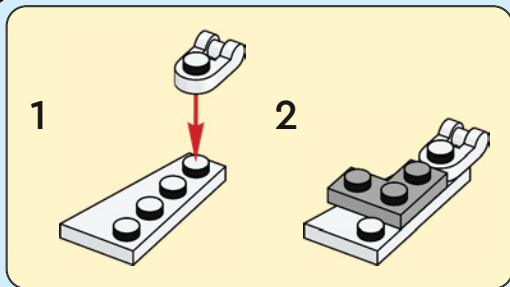



1x

16

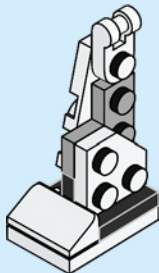

1x

17

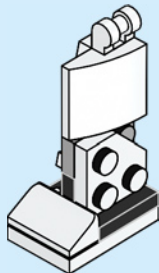

18

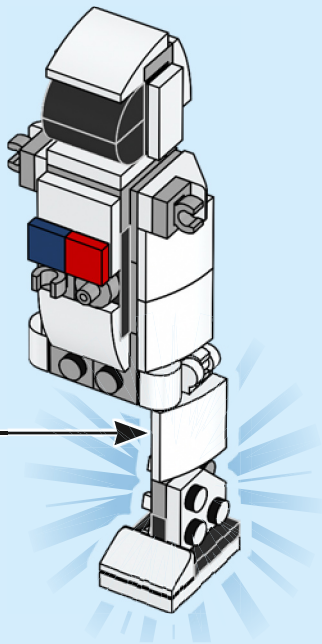



1x

19

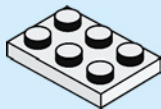



1x

20

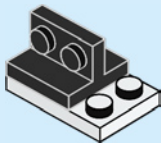

2x

21

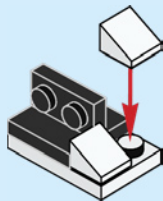

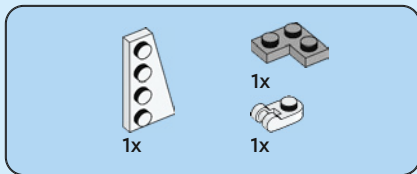

# 22

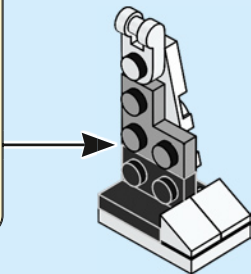
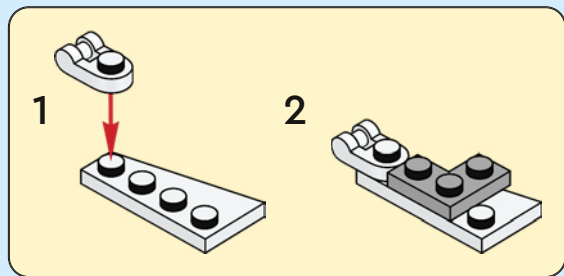



1x

23

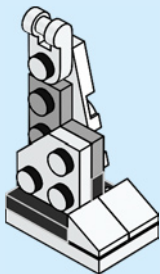

1x

24

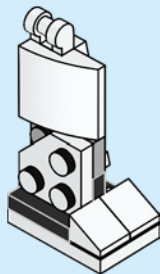

25

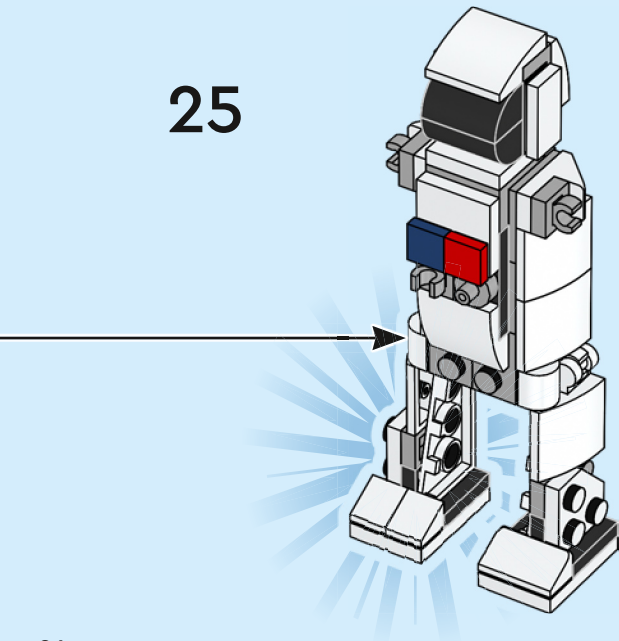



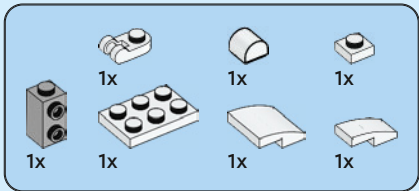

26

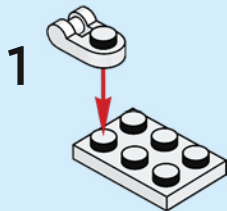

2

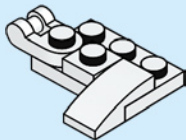

3

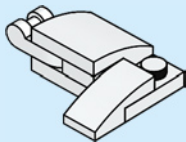

4

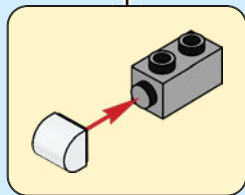
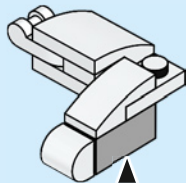

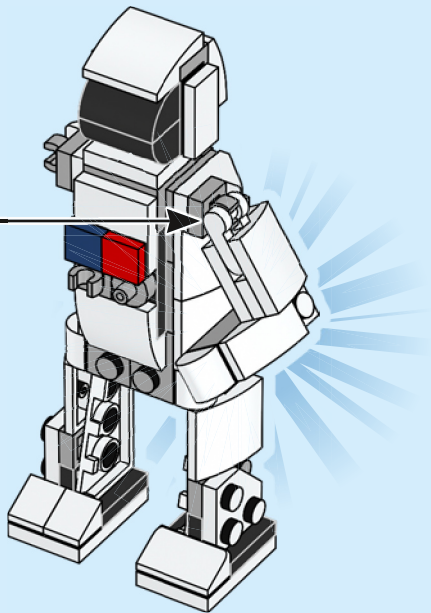



1x



1x



1x



1x



1x



1x



1x

# 27

# 1

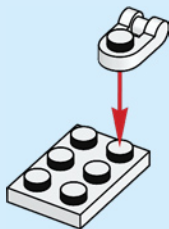

2

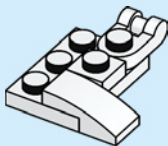

3

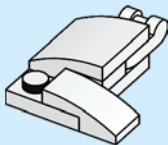

4

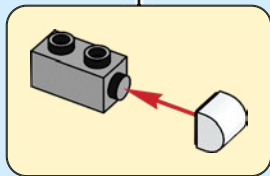
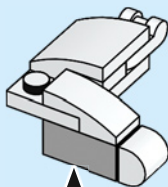

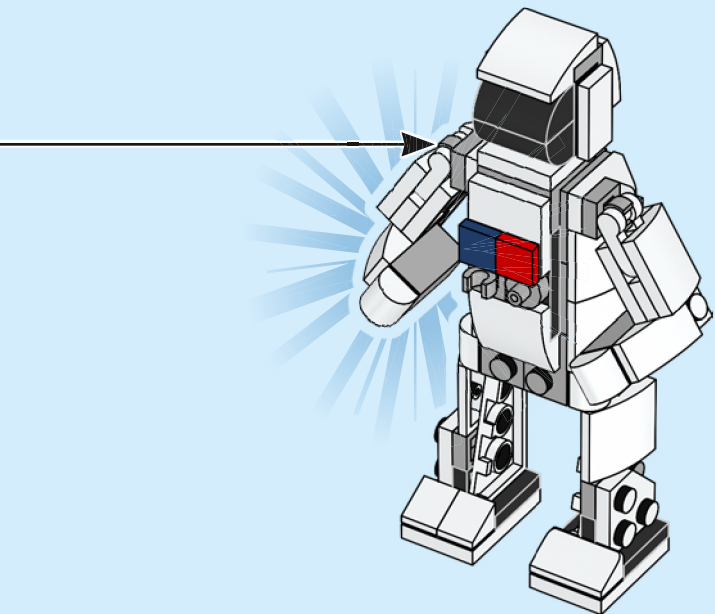

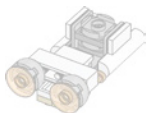

1x



1x

# 28

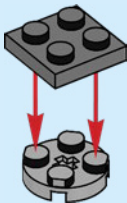

1x

# 29

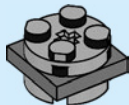



1x



1x

30

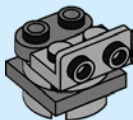

2x

31

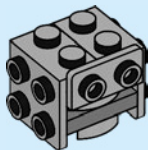





3x

32

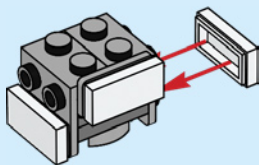

2x

33

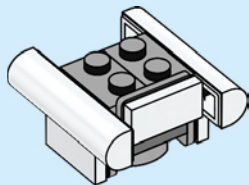

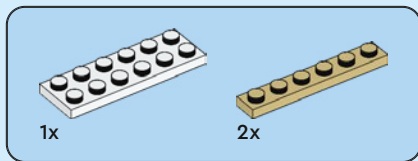

34

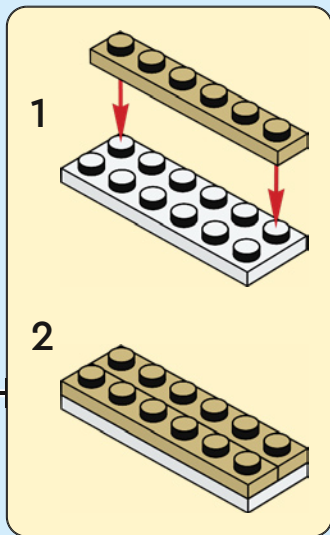
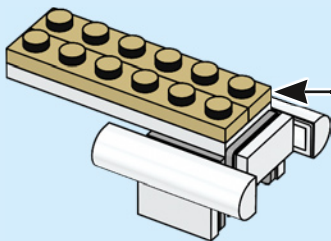



2x



1x

# 35

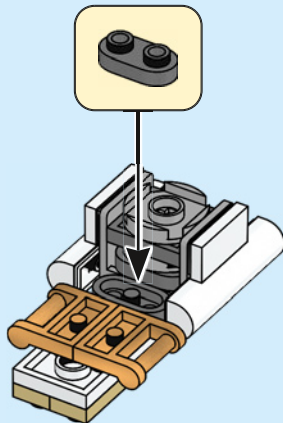

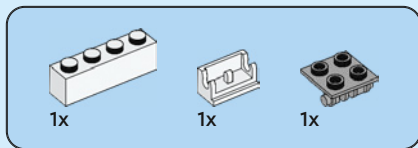

36

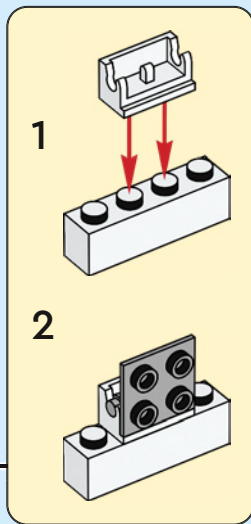
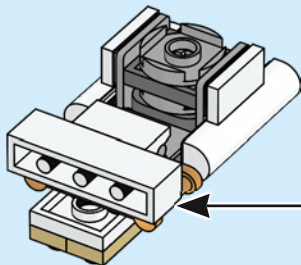



37

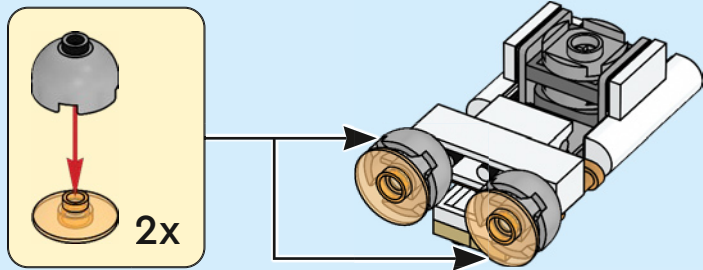



38

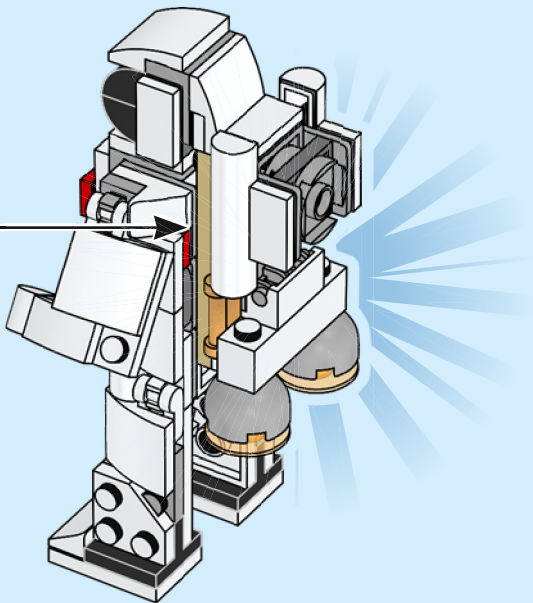

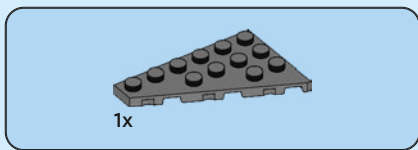
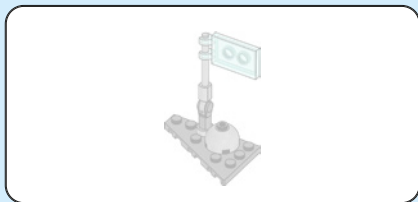

1x

1

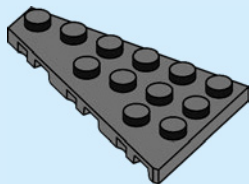



1x



1x



1x

# 2

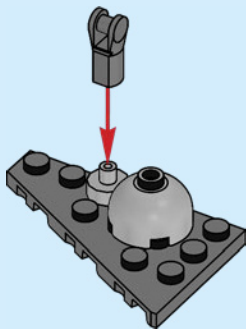



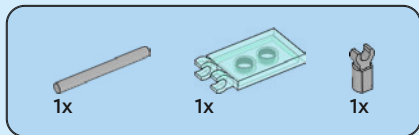

3

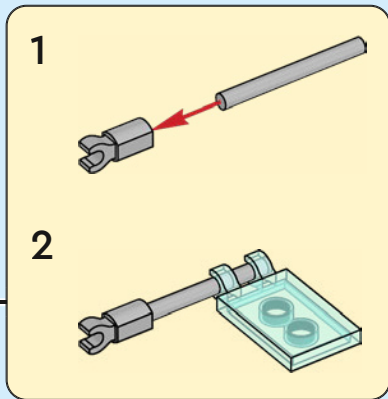
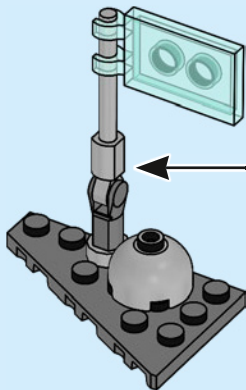

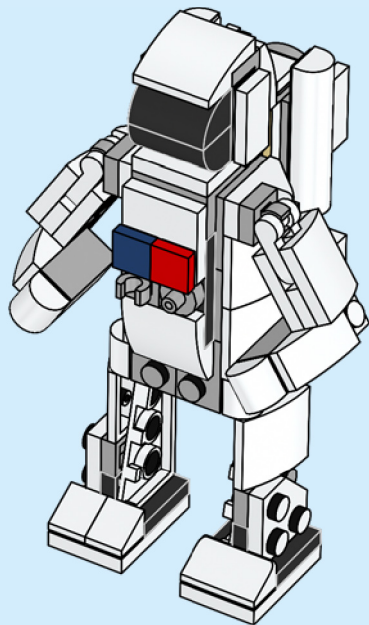
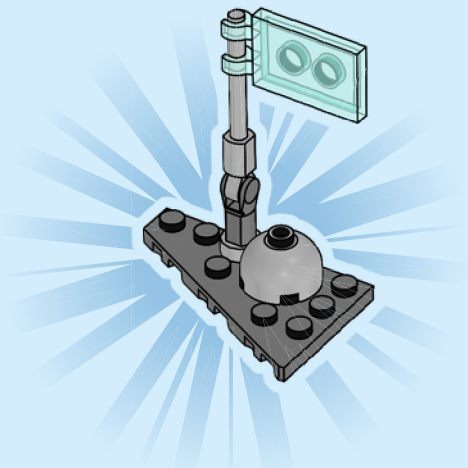

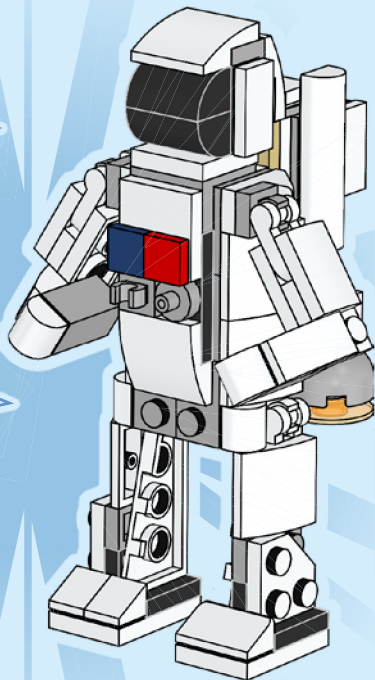
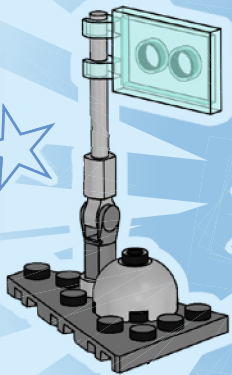



Rebuild  
the  
world™



LEGO and the LEGO logo are trademarks of the LEGO Group. ©2023 The LEGO Group.  
6457821



# CREATOR™

# 3 IN 1

## 31134



3 in 1  
3 en 1

3 em 1  
3 合 1

3 w 1  
3 v 1

3 az 1-ben  
3 in 1

„3 в 1“  
Kolm ühes

3 viename

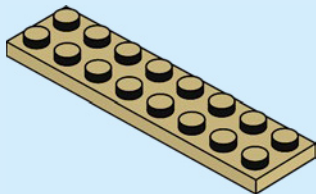
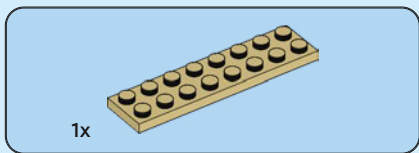

1



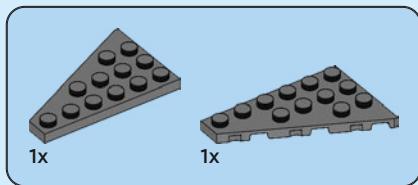

2

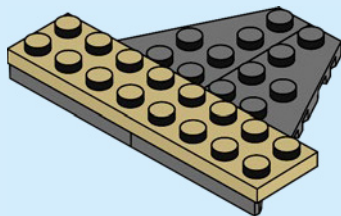

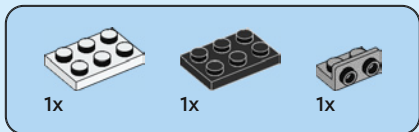

3

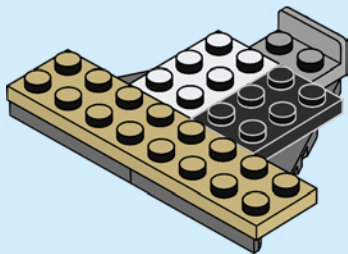



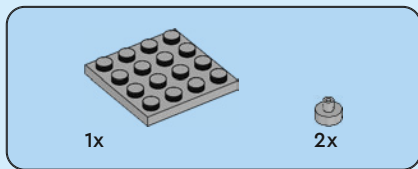

4

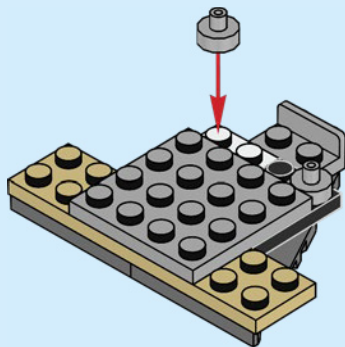



2x



1x



2x

5

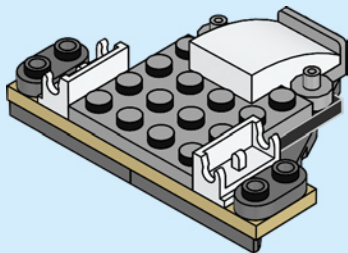

6

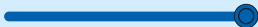



2x

6

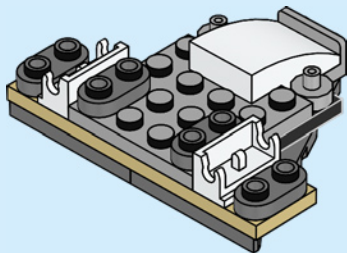



2x

7

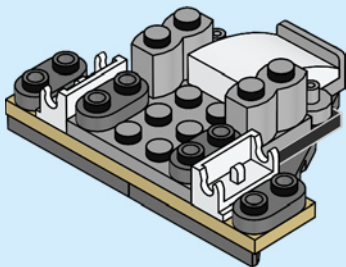

8

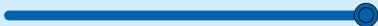



1x



2x

8

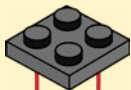

1



2

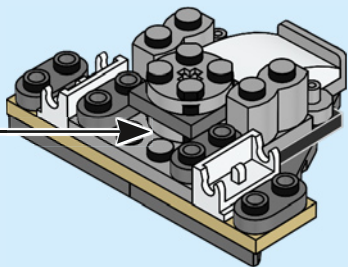



2x



2x

9



2x

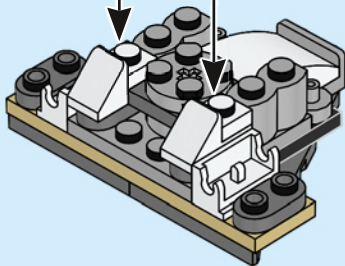



2x

10

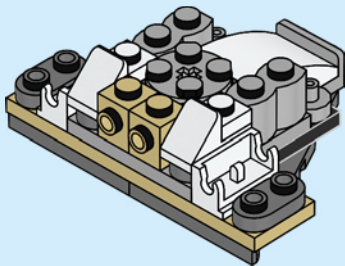



1x



2x

# 11

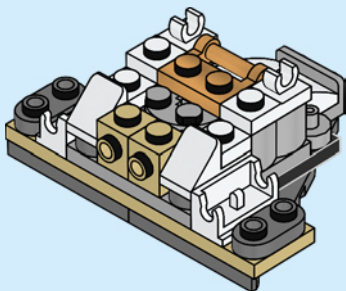





1x



2x

# 12

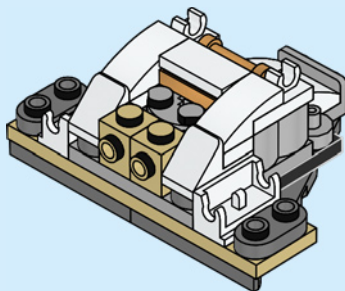



# 13

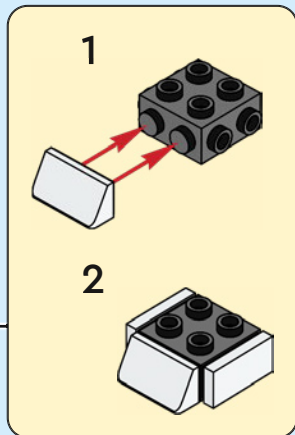
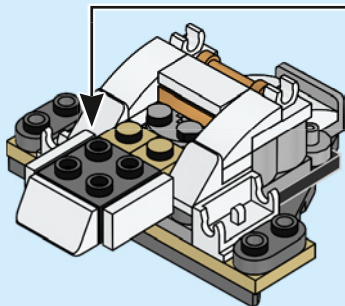

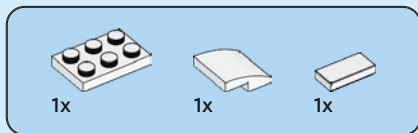

14

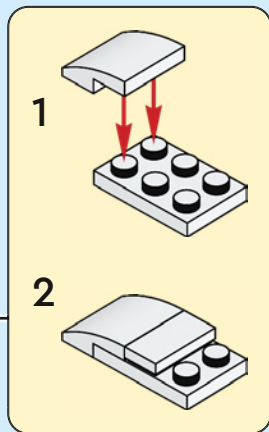
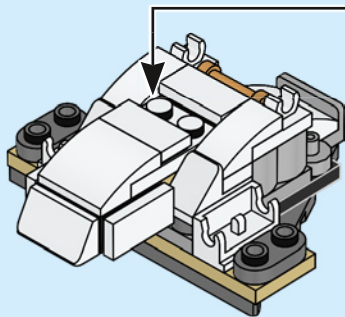



2x

15

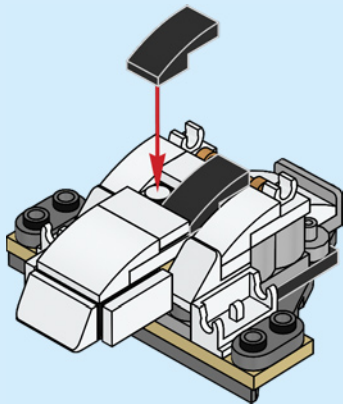



2x



2x

16

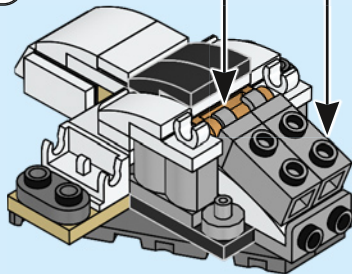

2x

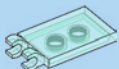

2x

17

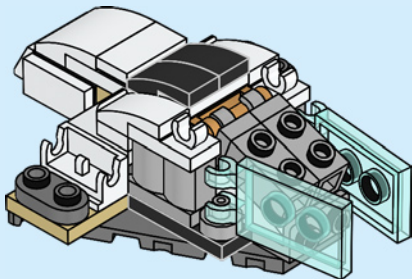



2x

18

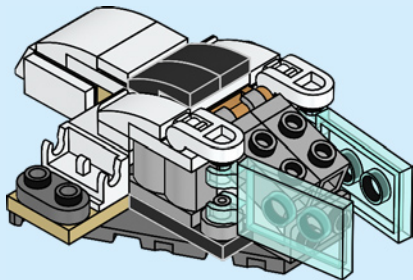

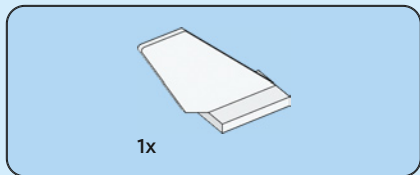

19

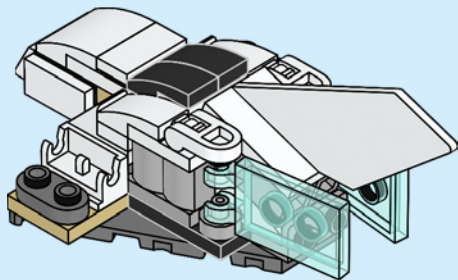



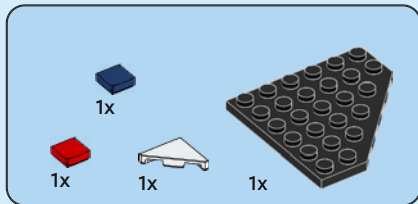
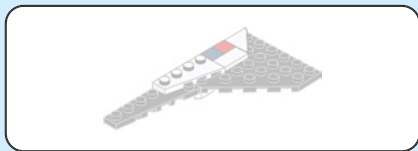

20

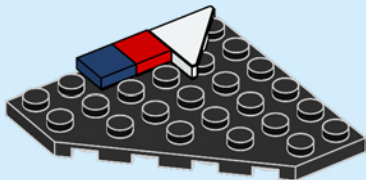

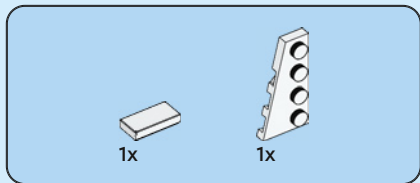

21

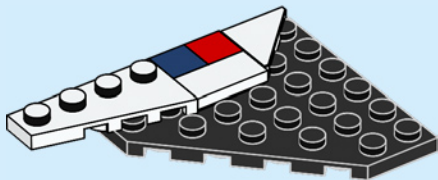

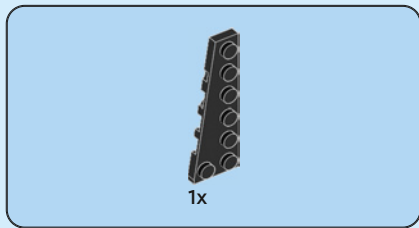

22

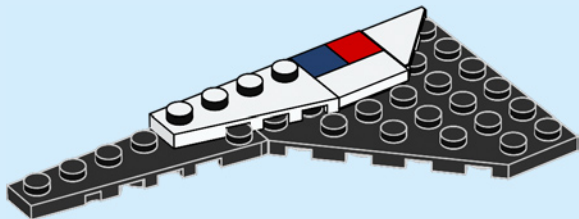

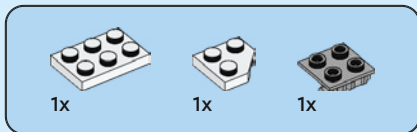

# 23

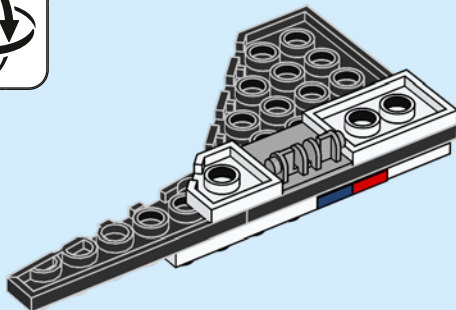
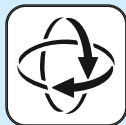

24

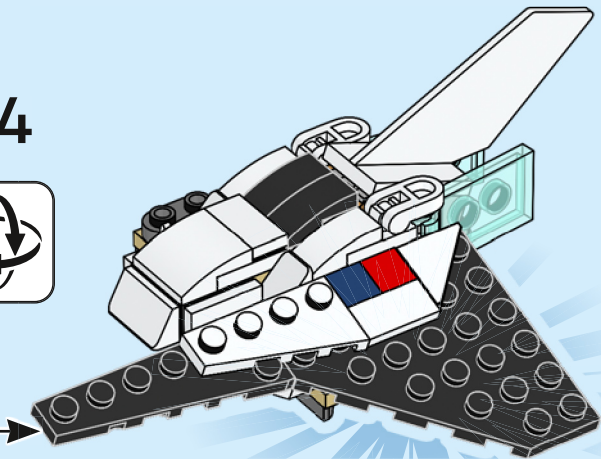

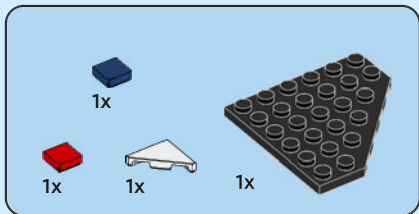
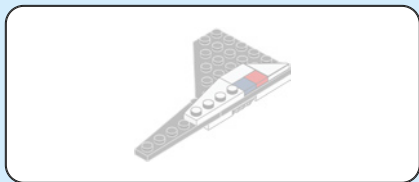

25

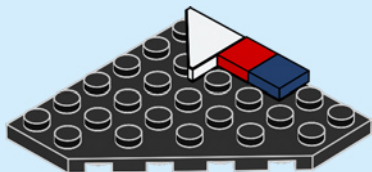

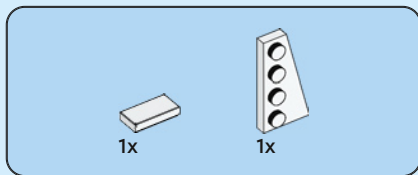

26

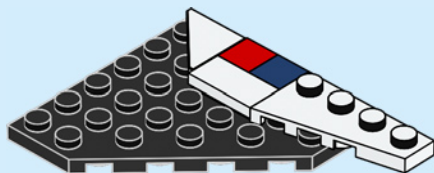



1x

27

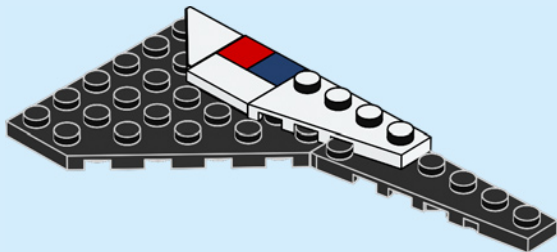





1x



1x



1x

# 28

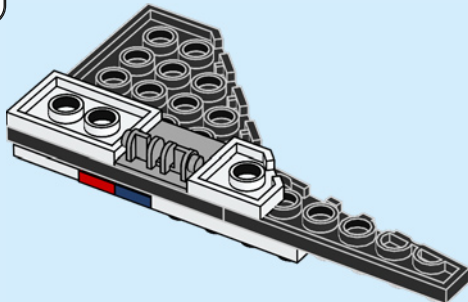

29

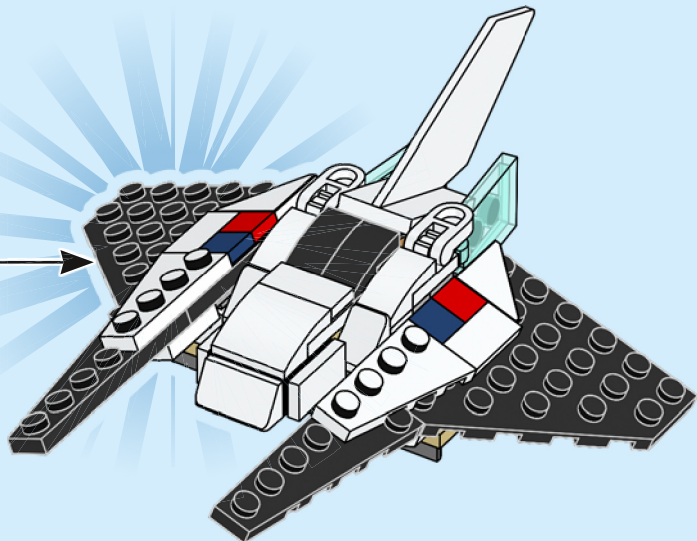

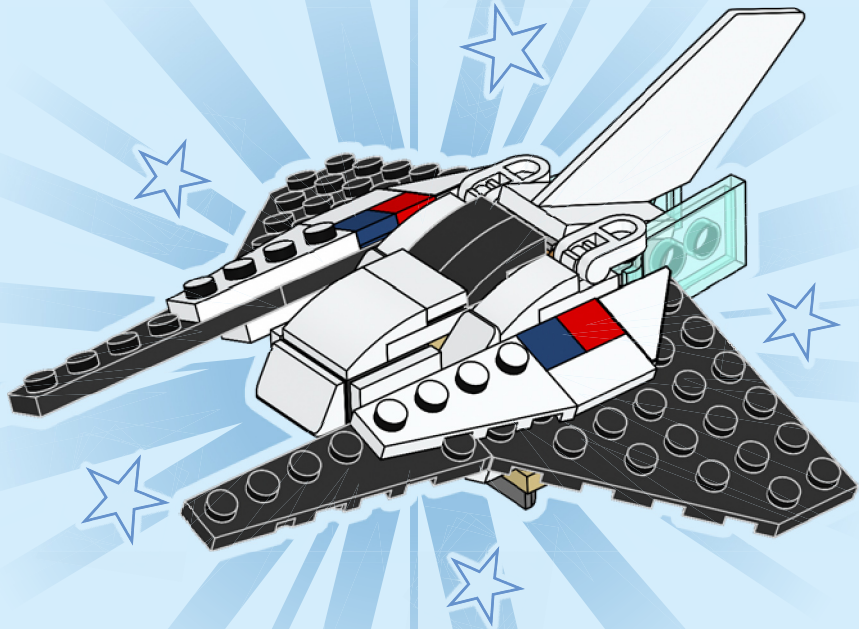



# CREATOR™

# 3 IN 1

31137



31139



31138

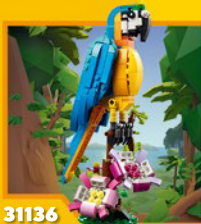

31136

31135



31134



31140



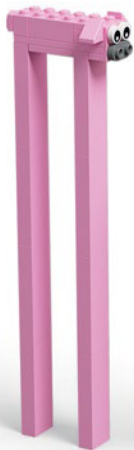

Rebuild  
the  
world™





2x  
4504369



2x  
302401



4x  
6258135



4x  
6174937



1x  
4160857



1x  
4161326



1x  
4547489

34



8x  
306901



2x  
393701



2x  
6347309



2x  
6069002



2x  
6034044



2x  
6176240



4x  
6217875



3x  
6218822



13x  
6047220



4x  
302101



2x  
6132212



2x  
6378416



1x  
301001



1x  
623901



2x  
379501



2x  
416201



2x  
4579260



1x  
4160483



1x  
4114319



1x  
4114309



2x  
4124067

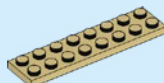

1x  
4113988



2x  
6047276



1x  
6310268



2x  
6250020



1x  
302126

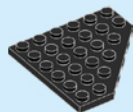

2x  
4106977

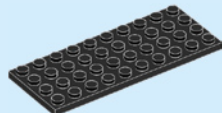

1x  
303026



3x  
6245310



2x  
307021



2x  
4585493



2x  
6275732



1x  
6344427



1x  
6344428



2x  
6245263



2x  
4631385



1x  
6355025



2x  
6258831



3x  
6308012



2x  
6225242



3x  
6429052



3x  
4211475



2x  
4550325



10x  
6117967



1x  
6004990



1x  
4211632



2x  
4211353



2x  
4211881



1x  
6116608



1x  
4243797



1x  
6397633



4x  
6221607



1x  
6314192



1x  
4211094



1x  
6266299

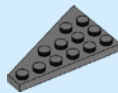

1x  
6266298



2x  
6348063



LEGO.com/service

YOU COULD

WIN



Scan this QR code or go to  
**LEGO.COM/PRODUCTFEEDBACK** and give us  
your short feedback about this LEGO® set  
for a chance to win a cool LEGO prize.

Terms and Conditions apply\*

**DE: Du könntest GEWINNEN.** Es gelten die Teilnahmebedingungen\* **FR: Tu pourrais GAGNER.** Des conditions s'appliquent\* **IT: Potresti VINCERE tu.** Termini e condizioni sono applicabili\* **ES: Puedes GANAR.** Aplican términos y condiciones\* **PT: Poderá GANHAR.** Aplicam-se termos e condições\* **JA: プレゼント付き! 利用規約が適用されます\*** **ZH: 轻松获奖. 条款和条件适用\*** **KO: 상품의 주인이 되어보세요. 소정의 약관이 적용됩니다\*** **RU: Вы можете ВЫИГРАТЬ.** Действуют положения и условия\* **PL: Szansa na WYGRANĄ.** Obowiązują warunki korzystania\* **CS: Máte šanci VYHRÁT.** Platí všeobecné smluvní podmínky\* **SK: Máte šancu VYHRATĚ.** Platia všeobecné zmluvné podmienky\* **HU: TE IS NYERHETSZ.** Felhasználási feltételek érvényesek\* **RO: Ai putea CÂȘTIGA.** Se aplică termenii și condiții\* **BG: Можете да СПЕЧЕЛИТЕ.** Има определени правила и условия\* **LV: Tu vari LAIMĒT.** Ir spēkā noteikumi un nosacījumi.\* **ET: Sul on võimalus VÕITA.** Kehtivad tingimused\* **LT: Jūs galite LAIMĖTI.** Taikomos sąlygos\*

\*[LEGO.com/productfeedback-terms](https://www.lego.com/productfeedback-terms)