

LED LIGHT PANEL HEATER

INSTRUCTION MANUAL

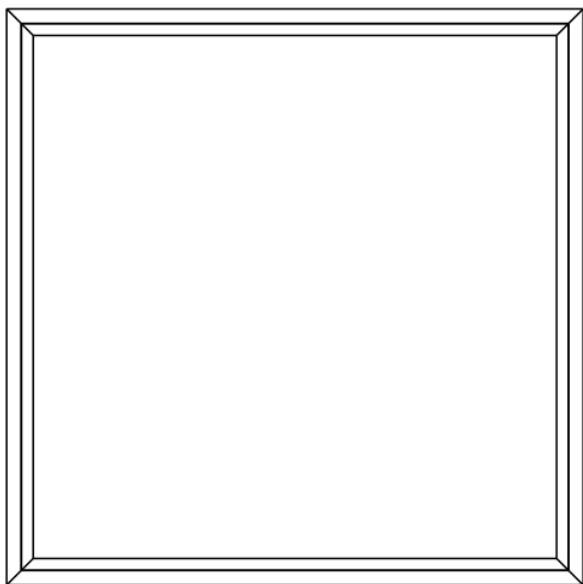

SYMBOLS







Warning

This signal word indicates a hazard with an average risk level which, if not avoided, can result in serious injury or death.



Warning of electrical voltage

This symbol indicates dangers to the life and health of persons due to electrical voltage.

Symbols	Meaning
	This symbol located on the device indicates that it is prohibited to place objects (such as towels, clothes etc.) above or directly in front of the device. In order to avoid overheating and fire hazards, the device must not be covered.
	This symbol located on the device indicates dangers to the life and health of persons due to hot surface.
	This symbol located on the device indicates that it is prohibited to spray the device.
	This symbol located on the device and information marked indicates that operating manual must be observed.

CONTENT

- 1 | WARNING & PRECAUTION
- 2 | FEATURES
- 3 | TECHNICAL INFORMATION
- 4 | SCOPE OF SUPPLY
- 5 | DEVICE STRUCTURE
- 6 | INSTALLATION
- 7 | THERMOSTAT
- 8 | INSTRUCTIONS OF WIFI CONNECTION
- 9 | OPERATION INSTRUCTIONS
- 10 | SECONDARY REMOTE CONTROL(OPTIONAL)
- 11 | TROUBLESHOOTING
- 12 | MAINTENANCE & SERVICING
- 13 | STORAGE
- 14 | TECHNICAL ANNEX
- 15 □ DISPOSAL

1 | WARNING & PRECAUTION

Read this manual carefully before starting or using the device. Always store the manual in the immediate vicinity of the device or its site of use!

Read all safety warnings and all instructions.

Failure to follow the warnings and instructions may result in electric shock, fire and / or serious injury. Save all warnings and instructions for future reference.

Warning

This series must be mounted above 1.8meters high!

Make sure the series you bought and install it in accordance to the tips in installation part!

Warning

This appliance can be used by children aged from 8 years and above and persons with reduced physical, sensory or mental capabilities or lack of experience and knowledge if they have been given supervision or instruction concerning use of the appliance in a safe way and understand the hazards involved.

Children shall not play with the appliance. Cleaning and user maintenance shall not be made by children without supervision.

Warning

Children of less than 3 years should be kept away unless continuously supervised.

Children aged from 3 years and less than 8 years shall only switch on/off the appliance provided that it has been placed or installed in its intended normal operating position and they have been given supervision or instruction concerning use of the appliance in a safe way and understand the hazards involved.

Children aged from 3 years and less than 8 years shall not plug in, regulate and clean the appliance or perform user maintenance.

Warning

Do not use the device in small rooms if persons are present who cannot leave the room independently and who are not under constant supervision.

Warning

Sensors with temperature detection, or temperature controller, should not be placed within the radiation range of 130 degrees of the ceiling heating plate, otherwise it will affect the actual temperature detection .

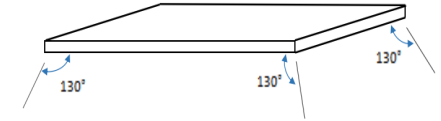

Warning

Some parts of this product can become very hot and cause burns. Particular attention has to be given where children and vulnerable people are present. Its dangerous of installation close to curtains and other combustible materials. To avoid the possibility of burns, the following people should be much more careful when using the heaters: infants and kids, people with sensitive skin, the old, the sick, people who is drunk, people who takes sleeping pills.

- Remove the protective film(on the front) before using.
- Be sure the usage voltage is between 220-240V, 50Hz, and power supply has been strictly in accordance with IEC, left is null wire and right is live wire, and also well grounded.
- The devices will draw more current than small appliances, so a separate 5A socket is required.
- Do not use the device in potentially explosive rooms.
- Do not use the device in aggressive atmosphere.
- Set the device up in an upright and stable position.
- Let the device dry out after a wet clean. Do not operate it when wet.
- Do not use the device with wet or damp hands.
- Do not expose the device to directly squirting water.
- Never insert any objects or limbs into the device.
- Do not cover or transport the device during operation.

- Do not sit on the device.
- This appliance is not a toy! Keep away from children and animals. Do not leave the device unattended during operation.
- Check accessories and connection parts for possible damage prior to every use of the device. Do not use any defective devices or device parts.
- Ensure that all electric cables outside of the device are protected from damage (e.g. caused by animals). Never use the device if electric cables or the power connection are damaged!
- The electrical connection must correspond to the specifications in chapter Technical data.
- Do not use the device when the socket or wire overloaded.
- Observe the device's power input, cable length and intended use when selecting extensions to the power cable. Completely unroll extension cables. Avoid electrical overload.
- Before carrying out maintenance, care or repair work on the device, remove the mains plug from the mains socket or disconnect the circuit.
- Switch the device off and disconnect the power cable from the main socket when the device is not in use.
- Do not use the device under any circumstances if any damages on the mains plug or power cable. If the supply cord is damaged, it must be replaced by the manufacturer, its service agent or similarly qualified persons in order to avoid a hazard. Defective power cables pose a serious health risk.
- During the installation of the device observe the minimum distances from walls and other objects as well as the storage and operating conditions specified in the Technical data chapter.
- Never drill into the heating device.
- Do not use the device in immediate proximity to curtains.
- Do not place the device on combustible ground.
- Do not transport the device during operation.
- Do not touch the surface during the device working to avoid burns.
- Allow the device to cool down before transport and / or maintenance work.
- Do not use this device near bathtubs, shower trays, swimming pools or other water containers. Risk of electric shock!

- The device must be placed where the switches and controllers cannot be touched by a person in a bathtub or shower.
- Do not use this device in a child-care centre and bathroom.(Only for Sweden)

2 | FEATURES

- The device is designed to provide an efficient, comfortable and healthy heating system for any domestic users.
- These devices can reduce air circulation and help to maintain a clean, silent, dust free environment.
- A wide range of devices available in a huge choice of colors, sizes and styles.

3 | TECHNICAL INFORMATION

LED Light HH series

Heating element	Carbon
Heating way	Far infrared heating
Input Voltage	220-240V/50Hz
Surface temperature	Main 130-150°C
Frame	Aluminum
Power cord length	≤1.9m

Model NO.	Size(mm)	Power(W)
IGT1-HH492-1*	522*522*35	280W
IGT5-HH560-1*	590*590*35	320W
IGT5-HH860-1*	590*890*35	520W
IGT5-HH1160-1*	590*1190*35	720W
IGT5-HH0606-1*	655*630*35	400W
IGT5-HH0706-1*	780*630*35	480W

IGT5-HH0707-1*	700*700*35	480W
IGT5-HH0806-1*	880*630*35	550W
IGT5-HH0808-1*	800*800*35	640W
IGT5-HH0906-1*	980*630*35	620W
IGT5-HH0909-1*	900*900*35	840W
IGT5-HH1006-1*	1080*630*35	700W
IGT5-HH1010-1*	1000*1000*35	1040W
IGT1-HH1106-1*	1180*630*35	760W
IGT1-HH1206-1*	1280*630*35	840W
IGT1-HH1306-1*	1380*630*35	900W
IGT1-HH1406-1*	1480*630*35	980W
IGT1-HH1506-1*	1580*630*35	1040W
IGT1-HH1606-1*	1680*630*35	1110W
IGT1-HH1706-1*	1780*630*35	1180W
*=L, it has LED light		

4 | SCOPE OF SUPPLY

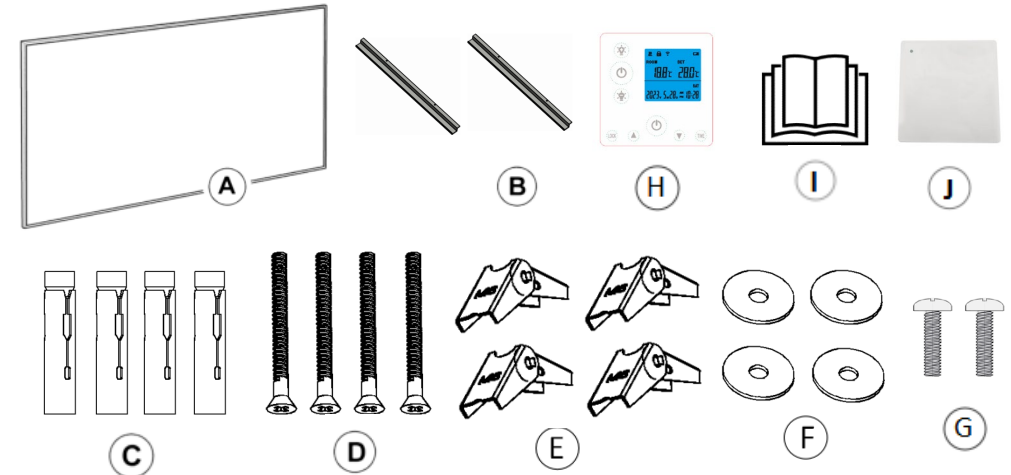

Tips:

and D are applied to concrete ceilings,

whereas D, E and F are used on gypsum board ceilings.

- A: Heating Device × 1
- B: Hanging Units × 2
- C: Metal Expansion Tubes × 4
- D: Screws × 4
- E: Spring Toggles × 4
- F: Washers × 4
- G: Screws × 2
- H: Thermostat × 1
- I: Manual × 1
- J: Secondary remote control × 1 (optional)

Front

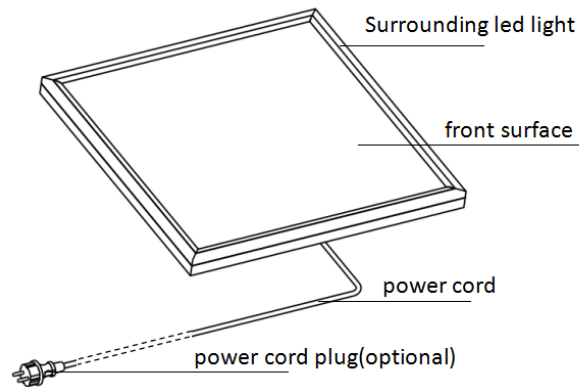

Rear

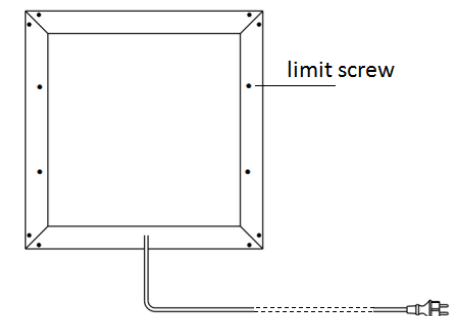

6 | INSTALLATION



Warning

- Mounting work must be carried out by professional electrician !
- Do not suspend panels by heating power cord !
- No any sticking ways are allowed to be used for hanging or suspending support !
- Make sure the ceiling is stable enough !
- Do remove the front protective film before using !
- Power cord must be well grounded!

Before starting the installation, please make sure to determine the material of the ceiling. The following are the installation methods for **concrete ceilings** and **gypsum board ceilings**. Please choose and use appropriate accessories based on the specific situation.

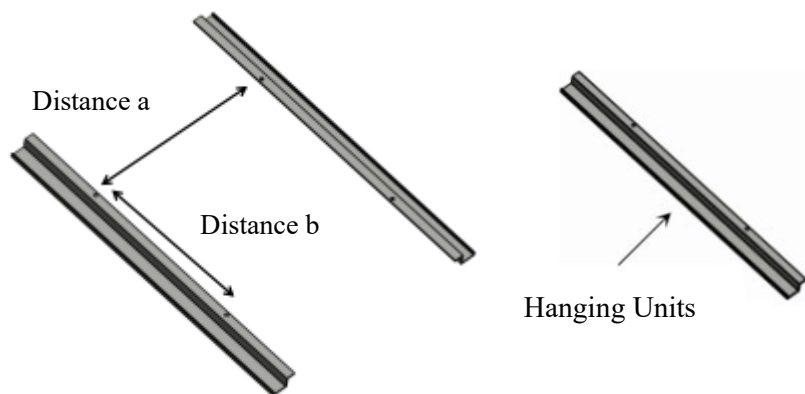

Panel Size/mm	Hole Distances of Screws/mm
655*630 (or similar)	a495*b100mm
1080*630(or similar)	a495*b300mm
1280*630 (or similar)	a495*b300mm

a. Concrete ceiling Installation

Step1: Measure and mark the correct distances "a" and "b" on the concrete ceiling where you want to install.

Step2:Drill four 10mm holes at the marked positions.



Excessive drilling diameter is strictly prohibited !

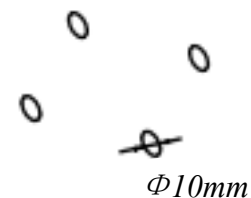

Step3: Insert the metal expansion tubes(C) into the drilled holes.

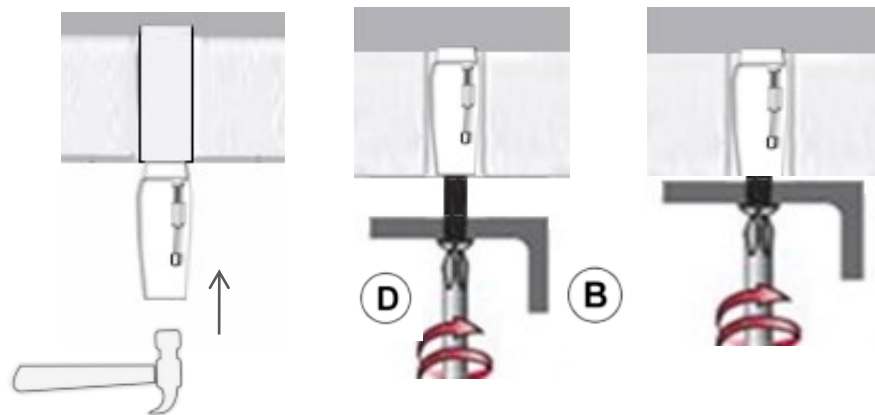

Step4: Thread screws(D) through the Hanging units(B) holes, then tighten them into the tubes.

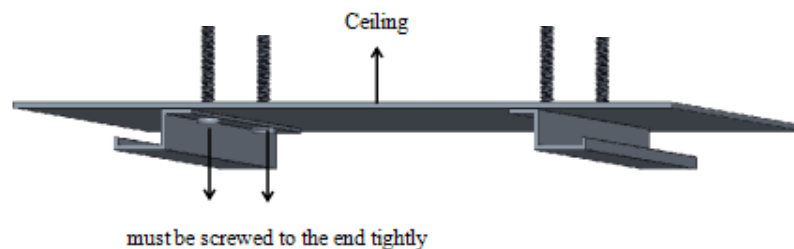

b. Gypsum Board Ceiling Installation:

Step1: Measure and mark the correct distances "a" and "b" on the concrete ceiling where you want to install.



1. Please note that the spring toggles (E) are designed for gypsum boards or wooden ceilings with a thickness ranging from 9-18mm. It is forbidden to be used on gypsum board ceilings with a thicknesses less than 9mm.

2. For wooden ceilings exceeding 18mm in thickness, consider employing metal expansion tubes (C) or using your own carpentry nails,ensuring the carpentry nails meet or exceed M5*40mm in size.

Step 2: Drill four 18mm holes at the marked positions.



Excessive drilling diameter is strictly prohibited !

Step 3:Thread screws(D) through the Hanging units(B) holes, washers(F) and spring toggles(E), and then insert the spring toggles(E) into the pre-drilled holes.

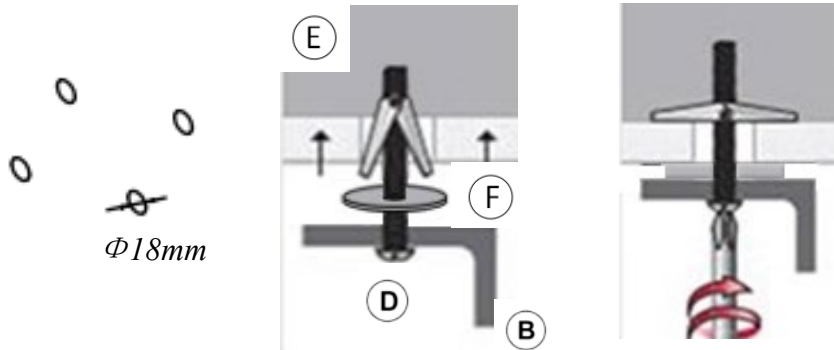

Step4: Tighten the screws.

Install the Heating Device (A) after completing installation of a or b

1. Push the rear of the left long frame into the hook, and then push back to make the rear of the right long frame into the other hook.

Note: 1.Hooks are for the two long frames only, not the two short ones!

2. Make sure the hooks are between the two limit screws !

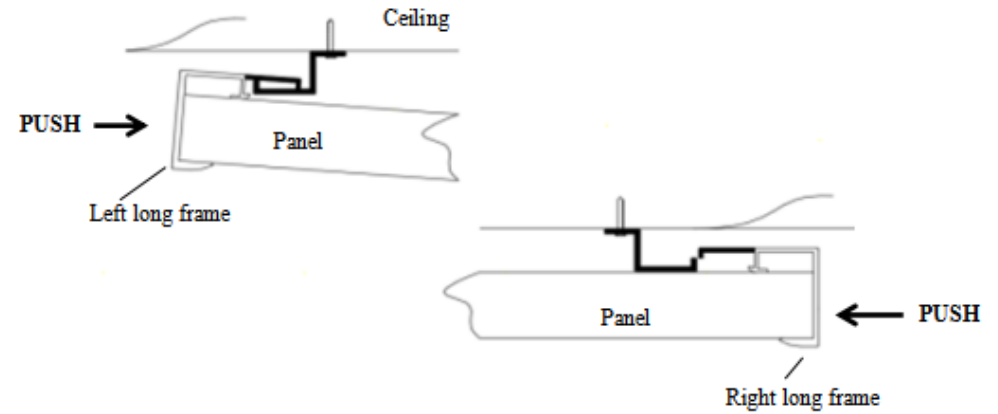

2. To avoid falling off, you must slide the panel left and right to make sure the two hooks have been completely put into the rear of the two long frames!

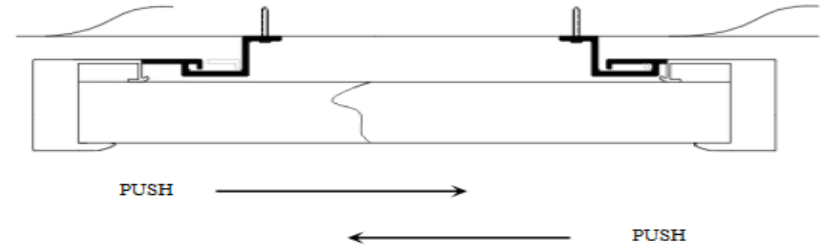

3. Screw the screws(G) into the holes reserved on both sides of the product and tighten.

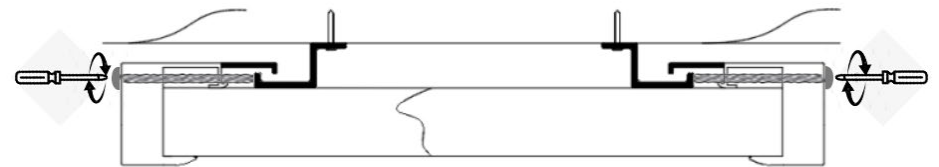

7 | THERMOSTAT

Specification

- Battery-powered: DC 4x 1.5V AAA batteries (not included)
- Set temperature range: 5°C~ 35°C, resolution: 1°C
- Room temperature range: 0°C~ 50°C, display resolution: 0.1°C
- Accuracy of the measured temperature: ±0.5°C
- Working environment range 1°C~ 50°C
- Radio frequency 433.92MHz

Description

Operation Part for Light

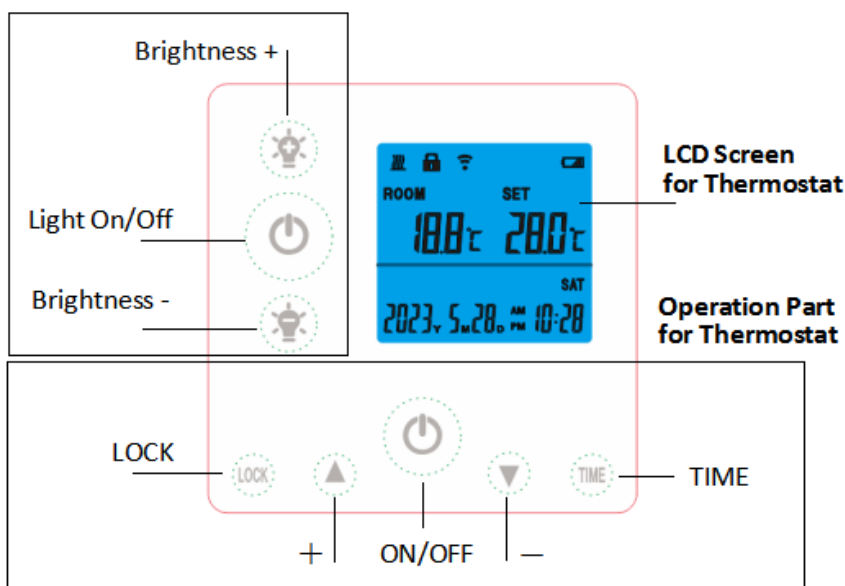

1. This thermostat also includes individual operation part for LED light.
2. The thermostat acquires the room temperature with its integrated sensor and transmit signal to the panel to turn on/off heating as the ambient temperature changing, in order to maintain a constant room temperature. When the ROOM temperature is 0.5°C higher than the SET temperature, thermostat will send OFF commands to panel; When the ROOM temperature is 0.5°C lower than the SET temperature, thermostat will send ON commands to panel to turn on

heating function.

3. The screen display shows the setting temperature as well as the measured temperature, time, date, modes etc.
4. The thermostat has temperature setting, auto-off when temperature jump, time setting functions etc.
5. It is powered by 4pcs of 1.5V AAA batteries. Please change with new ones if the battery symbol gets flashing, or else it will not be able to control the panel.
6. Keypad locking function is designed to prevent the children from misusing.
7. LCD screen powered off means only the panel heating power off, the remote control itself is still under working state until batteries dead/out or broken.
8. The LCD screen only can work in temperature range from 1°C~ 50°C.

Operation

1. Power on the panel, press ON/OFF for thermostat, then long press LOCK and TIME buttons at same time for 3 seconds to pair the thermostat and panel until long beep sound.

NOTE:

- 1) Pairing should be finished within 1 minute, or else you need to re-power on the panel.
- 2) Please re-power on the panel if you want to pair the panel with another thermostat.
- 3) One thermostat can be paired to and work with several panels at same time.
- 4) Before pairing please do power off those panels which you don't want to pair.
2. Press ON/Off button for LED light to turn on/off the led light surrounding the panel, and **long press** to switch light color (for some models only).
3. Press +/- to adjust the brightness, short press can adjust brightness to 100%, 75%, 50% and 25%, long press can adjust from 100% to 5%.
4. Press ON/Off button for thermostat to turn on/off the heating power.
5. Long press LOCK 3 seconds to lock/unlock the buttons.
6. Press + and - buttons to convert the temperature display measurement unit.
7. Long press TIME 3 seconds to set year, month, date and time with UP and DOWN buttons.
8. Press UP and DOWN to set target temperature.
9. The thermostat will automatically turn off the heating device if a sudden drop in temperature in the room is detected.

- The symbol  means heating, it only displays when room temperature is 0.5°C (or more) lower than set temperature.
- The backlight will be ON when press any button in the state of power-on.

Notes

- All settings need to be re-set after battery replacement.
- Alkaline battery is recommended. If ALL buttons on the thermostat are not working, try replacing the batteries.
- Please do not change the batteries with new ones once the screen battery symbol gets flashing, or else it may result in halted/stuck/not working.
- Check if set temperature is higher enough than room temperature first if the heating can not be turned on by thermostat.
- Do not cover or touch the temperature sensor which is at the top of the thermostat.
- Do not put the thermostat in a open normal room environment rather not inside a drawer/pocket or under pillow/quilt etc.
- Please do not take out the batteries from the thermostat if long time no use.

8 | INSTRUCTIONS OF WIFI CONNECTION

- Before pairing, please make sure your mobile phone connects to your 2.4ghz WIFI signal invariably.
- Scan and install below Smart Life APP, and Register an account.



- Power on the heater and it will beep automatically, **long press LOCK and ON/Off button 6s by thermostat until the front corner blue indicator light blinks.**
NOTE: same operation is necessary when WiFi hotspot changed, WiFi password changed, or cell phone changed.

corner indicator light with red and blue colors

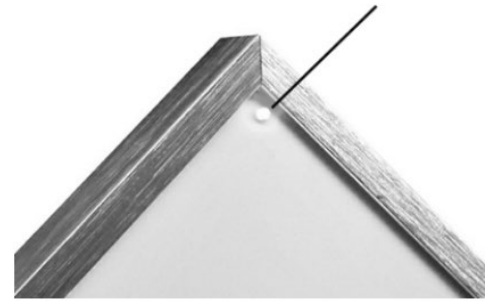

Blue color means online

Red color means heater powering on

- Click Smart Life App to enter main interface, Select room name and click "Add Device" or the upper right corner "O,+ " icon. A pop-up window appears as below picture.

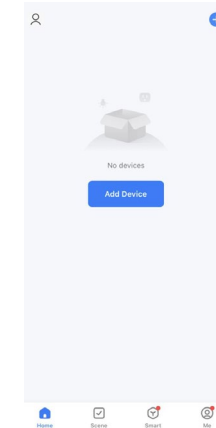

- Click "Add", an Enter Wi-Fi Information dialog will pop-up as following.

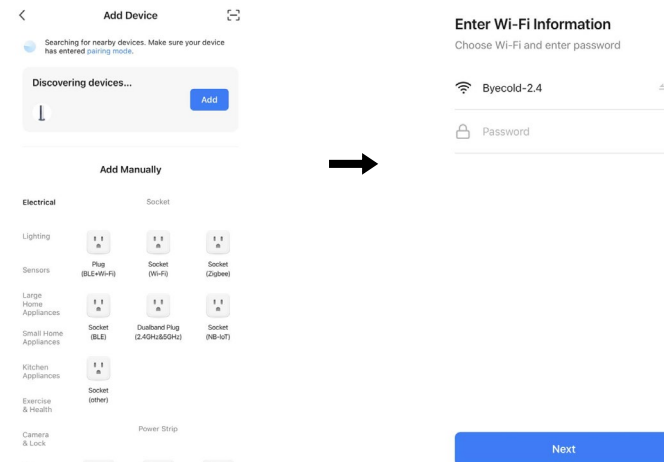

- Enter Wi-Fi password, click“Confirm”, It will automatically enter the next step for WIFI connection. The device will be added successfully after waiting for 20-30 seconds. And meantime the blue indicator at the front corner of heater lights up. You can name this device, e.g. “Infrared panel heater”.

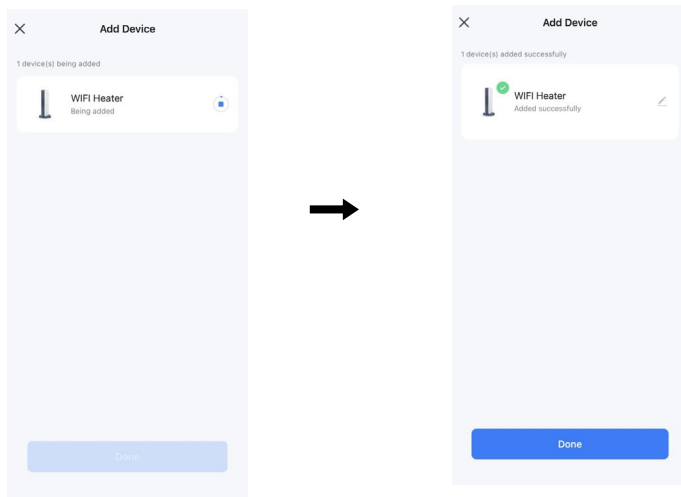



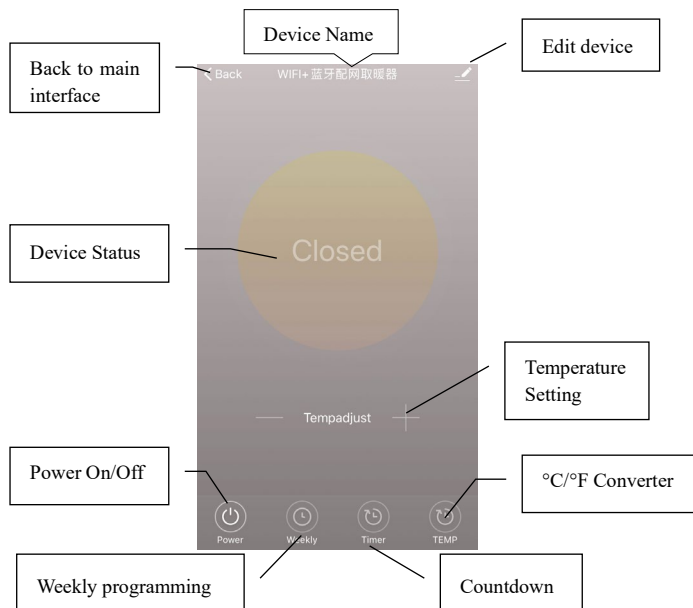



Note: If the connection is timed out in Step 6, please Repeat Step 3-6.

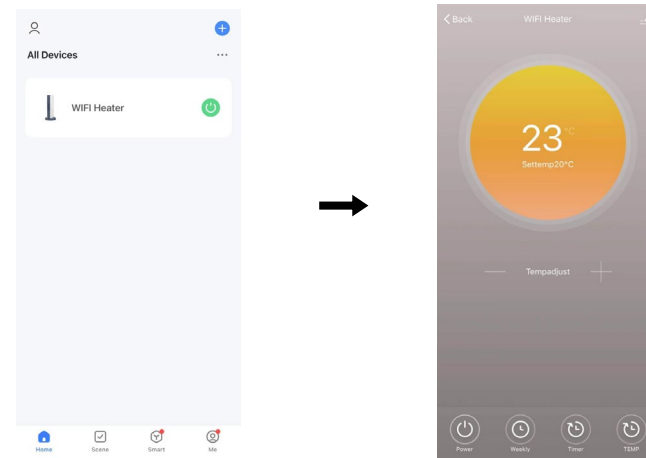

9 | OPERATION INSTRUCTIONS

- Main view of the Smart Life APP after heater connected successfully as below.



- Click the green  to turn on/off the power supply of the heater, red indicator on heater panel lighting up means the heater has been powered on.
- Click device name “infrared panel heater” to enter the interface of the device.
-  means turning on/off the power supply of the heater, setting temperature should be also at least 0.5 °C higher than room temperature if you want the heater to be powered on.
-  means weekly programming mode. Under weekly mode, users can program the heater to change the operation and desired temperature throughout the week. ON and OFF timing is separate, you need to add individually. Don't forget to turn ON the weekly button to Green after programming..
Note: weekly will still work as per setting even under APP powering off state.
-  is countdown function for setting to power off the heater.
Note: APP powering off will cause timer setting canceled.
-  means convert temperature display between °F and °C
Note:Weekly, Timer and TEMP these three functions can be edited only under power on mode!
-  means other editing of the heater, description as below.
 - Device name: edit the thermostat name.

- 2) Device information: to check the virtual ID etc device information.
- 3) Share device: you can share the control of this thermostat to other mobile numbers/email addresses if they have been registered in "Smart Life" APP.
- 4) Create Group: you can group different thermostats to control together.
- 5) FAQ & Feedback: to report any problems to the APP supplier.
- 6) Add to the home interface: you can turn on the heater directly on the home interface.
- 7) Check Device network: check the wifi connection status of device.
- 8) Check Update: Get latest firmware version.
- 9) Remove Device: remove thermostat from your APP.

Notes

1. The heater only support 2.4GHz network.
2. Blue light means the heater is online, red light means the heater is powering on.
3. WiFi or network disconnected will cause heater offline and heater powering off.
4. The blue LED indicator may not light up at the first time when you finished the WIFI connecting, you need to wait for a couple of seconds due to network searching and connecting.
5. Do not use heaters in wet or running water environment.
6. Please pull out the heater power supply from your socket if long time no use.
7. Both the remote-controller and App can turn on/off the heater and set the temperature. The remote-controller setting can be linked to the App, but the App setting cannot be linked to the remote-controller.
8. If the connection between remote and the built in receiver breaks and the temperature data can't be received for 5 minutes, the APP will display --, and the heater will stop heating, meanwhile, the mobile will get a warning message. If the connection is done again, the APP will display real room temperature.
9. If the remote-controller is disconnected, please bring the remote-controller close to the heater(less than 3 meters) and repair.
10. If the remote-controller is always disconnected at one location, move it somewhere else.

10 | Secondary remote control (optional)

Specification

- Battery-powered: 2x3V CR2032 button batteries
- Working environment range 1°C~ 50°C
- Radio frequency 433.92MHz

Description



Short press to control
the LED light

1. The function of the secondary remote control is to turn ON/OFF the LED light surrounding the panel.
2. This secondary remote control can not adjust the brightness and color of the lights.
3. This secondary remote control requires no wiring, you can use double-sided tape to secure it in place and use it as a wall switch.

Pair the secondary remote control with the heating device

For first-time users, the secondary remote control needs to be paired with the heating device. After powering on, press and hold the secondary remote control switch for more than 6 seconds within one minute to begin pairing. Once pairing is successful, short press the switch to control the LED light.

Note:

- 1) Before pairing please do power off those panels which you don't want to pair.
- 2) Pairing should be finished within 1 minute, or else you need to re-power on the heating device.
- 3) One heating device can be paired with a maximum of one main thermostat and

two secondary remote controls, all of which can control the LED light.

Replace button battery

Use a flat-head screwdriver to pry open the casing from the notch provided at the top of the secondary remote control. Then, insert the button battery into the battery slot following the correct polarity, or replace it.



pry open the casing from this point

Notes

1. Put the secondary remote control at most 5 meters from the heating device.
2. If the secondary remote control is disconnected, please bring the remote control close to the heating device (less than 3 meters) and repair.
3. No need to re-pair after replacing the battery.
4. If the secondary remote control fails, please replace the battery and try again.

11 | TROUBLESHOOTING

Problem	Reason	Measure
It has noise when original charged with electricity	Due to the structure stress of the heat insulator.	It is a normal phenomenon. Don't worry about it.
The surface of the device was slightly raised.	Due to the thermal expansion of the surface material.	It is a normal phenomenon. Don't worry about it.
The surface of the heating device is slightly warm.	1. The voltage is low. 2. In a low-temperature environment.	1. Install a voltage regulator. 2. It is normal.

12 | MAINTENANCE & SERVICING

Activities required before starting maintenance



Warning of electrical voltage

- If the power cord comes without plug, disconnect the circuit before connecting it.
- Do not touch the mains plug or power cord connection with wet or damp hands.
- Hold onto the mains plug while pulling the power cable out of the mains socket.
- Allow the device to cool down completely.



Warning of electrical voltage

Tasks which require the housing to be opened must only be carried out by authorized specialist companies.

Cleaning the device



Warning of electrical voltage

Never immerse the device in water!

Clean the device with a soft, damp and lint-free cloth.

Ensure that no moisture enters the housing. Protect electrical components from moisture. Do not use any aggressive cleaning agents such as cleaning sprays, solvents, alcohol-based or abrasive cleaners to dampen the cloth.

Wipe the housing dry after cleaning.

13 | STORAGE

When the device is not being used, observe the following storage conditions:

- dry and protected from frost and heat
- in an upright position where it is protected from dust and direct sunlight

- with a cover to protect it from invasive dust, if necessary
- Place no further devices or objects on top of the device to prevent it from being damaged.

14 | TECHNICAL ANNEX

Information requirements for electrical local space heaters

Item	Unit
Type of heat input, for electric storage local space heaters only (select one)	
manual heat charge control, with integrated thermostat	[no]
manual heat charge control with room and/or outdoor	[no]
electronic heat charge control with room and/or outdoor	[no]
fan assisted heat output	[no]
Type of heat output/room temperature control (select one)	
single stage heat output and no room temperature control	[no]
Two or more manual stages, no room temperature control	[no]
with mechanic thermostat room temperature control	[no]
with electronic room temperature control	[no]
electronic room temperature control plus day timer	[no]
electronic room temperature control plus week timer	[yes]
Other control options (multiple selections possible)	
room temperature control, with presence detection	[no]
room temperature control, with open window detection	[yes]
with distance control option	[no]
with adaptive start control	[no]
with working time limitation	[yes]
with black bulb sensor	[no]

15 | DISPOSAL



The icon with the crossed-out waste bin on waste electrical or electronic equipment stipulates that this equipment must not be disposed of with the household waste at the end of its life. You will find collection points for free return of waste electrical and electronic equipment in your vicinity. The addresses can be obtained from your municipality or local administration.

The separate collection of waste electrical and electronic equipment aims to enable the re-use, recycling and other forms of recovery of waste equipment as well as to prevent negative effects for the environment and human health caused by the disposal of hazardous substances potentially contained in the equipment.