



Safety Instructions

This product is for household use only. Read this manual carefully before use, and retain it for future reference.

- This appliance can be used by children aged from 8 years and above and persons with reduced physical, sensory, or mental capabilities or lack of experience and knowledge if they have been given supervision or instruction concerning use of the appliance in a safe way and understand the hazards involved. Children shall not play with the appliance. Cleaning and user maintenance shall not be made by children without supervision.
- The appliance is only to be used with the power supply unit provided with the appliance.
- This vacuum cleaner is for indoor use only. Do not use or install it in outdoor, industrial, or commercial environments.
- Do not charge or store the vacuum cleaner near heat sources or in humid areas, such as by a radiator or in a kitchen or bathroom.
- Be aware of the risk of terminals of the battery-operated appliance or battery being short-circuited by metal objects.
- Do not touch the plug or any electrical part with wet hands.
- Only use replacement parts that are approved by Xiaomi.
- Before installing, removing, or replacing any parts, or cleaning or maintaining the vacuum cleaner, make sure to turn it off and unplug the power supply to prevent personal injury.
- To reduce the risk of fire, explosion, or personal injury, check before use to make sure the power supply is undamaged. Do not use the vacuum cleaner if the power supply is damaged.
- Do not block the air inlet or outlet to prevent the vacuum cleaner from overheating and becoming damaged.
- Do not place any objects on the vacuum cleaner's suction opening.
- Do not use the vacuum cleaner if any part of it is damaged or not installed correctly.
- When lifting or carrying the vacuum cleaner, make sure it is turned off, otherwise there may be a risk of personal injury.
- During use of the vacuum cleaner, keep its moving parts such as the brush head away from people and pets.
- When using the vacuum cleaner to clean stairs, make sure to pay attention to personal safety.
- Do not use the vacuum cleaner to clean up fine dust, such as drywall dust or fireplace ash.
- Do not use the vacuum cleaner to clean up smoldering or burning materials such as charcoal, cigarette butts, or matches.
- Do not use the vacuum cleaner to clean up sharp or hard objects, such as glass, nails, screws, or coins.
- Do not use the vacuum cleaner to clean up highly greasy, sticky, or pigmented stains such as shoe polish, paint, or pigments.
- Do not use the vacuum cleaner to clean up flammable or explosive liquids such as gasoline, or any toxic solutions such as chlorine bleach, ammonia, or drain cleaner.
- Do not use the vacuum cleaner to clean up toner or ink used in laser printers or photocopiers, as this may cause fire or explosion.
- Do not lean the vacuum cleaner on unstable objects such as chairs or tables, as it may fall over and cause damage or injury.
- Do not submerge the vacuum cleaner or any of its parts in water or any other liquid for cleaning. After cleaning or maintenance of the vacuum cleaner, make sure that all parts of it are fully dry before reinstallation and use.
- Do not use the vacuum cleaner if its opening is blocked. Clean regularly to keep it free of dust, lint, hair, or other debris; otherwise, the airflow may be compromised.
- If the vacuum cleaner has the problem of overheating, strange noise, odor, or weak suction power, contact the after-sales service team. Do not repair it by yourself.
- The vacuum cleaner should only be repaired by the after-sales service team to ensure it remains safe to use.
- Do not use any third-party battery or power supply.
- Do not expose the appliance or battery to excessive temperatures.
- If the power supply is damaged, it must be replaced by a professional from the manufacturer, after-sales service department, or similar department to avoid safety hazards.
- **Fire Hazard Warning:** Do not apply any type of fragrance to the vacuum cleaner's pre-filter and post-filter. These types of products are known to contain flammable chemicals which may cause the vacuum cleaner to catch fire.
- Strictly follow the instructions in this user manual to charge the vacuum cleaner at an ambient temperature of 5°C to 35°C. Improper charging may result in damage to the battery.

- Please strictly follow the instructions in this user manual when using the vacuum cleaner. Users are responsible for any loss or damage that may arise from improper use of the vacuum cleaner.
- **WARNING:** Only use the supply unit provided with this appliance.
- **WARNING:** For the purposes of recharging the battery, only use the detachable supply unit provided with this appliance.
- Use only with BLJ48WF350130P-V supply unit.
- No action is needed from users to shift the power between 50 Hz and 60 Hz, as the product can adapt itself for both 50 Hz and 60 Hz.



For indoor use only



Before use, read the instructions

Regulatory Compliance Information



EU Declaration of Conformity

We, Xiaomi Communications Co., Ltd., hereby declare that this equipment is in compliance with the applicable Directives and European Norms, and amendments. The full text of the EU declaration of conformity is available at the following internet address:
<https://www.mi.com/global/support/terms/declaration>



WEEE Disposal and Recycling Information

All products bearing this symbol are waste electrical and electronic equipment (WEEE as in directive 2012/19/EU) which should not be mixed with unsorted household waste. Instead, you should protect human health and the environment by handing over your waste equipment to a designated collection point for the recycling of waste electrical and electronic equipment, appointed by the government or local authorities. Correct disposal and recycling will help prevent potential negative consequences to the environment and human health. Please contact the installer or local authorities for more information about the location as well as terms and conditions of such collection points.

Product Overview

Accessory List

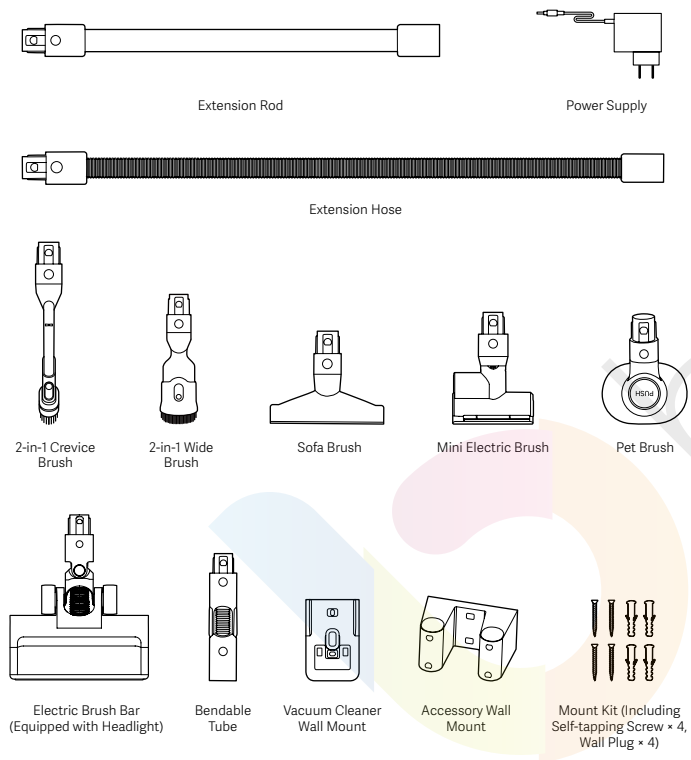

Note: Illustrations of product, accessories, and user interface in the user manual are for reference purposes only. Actual product and functions may vary due to product enhancements.

Vacuum Cleaner

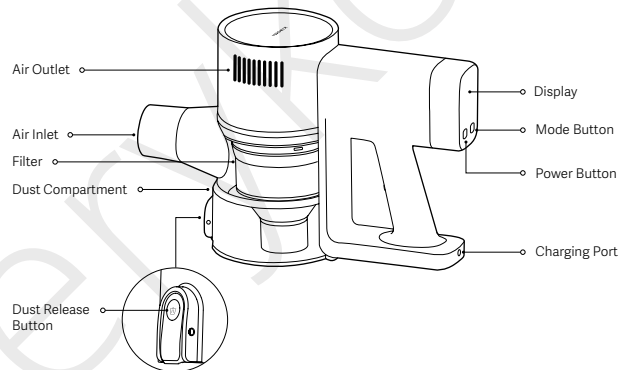

Display

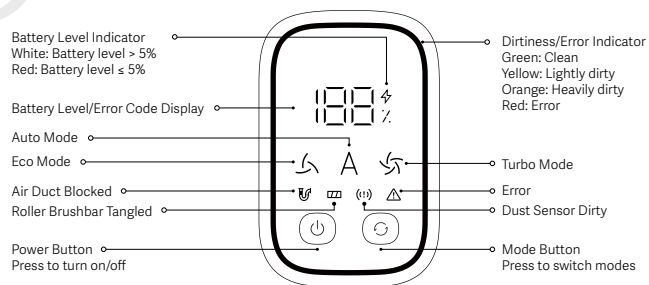

Note: If the vacuum cleaner malfunctions, the display will show the corresponding error indication. For solutions, refer to the Troubleshooting section. If the issue persists, contact the after-sales service team.

How to Install

Installing Accessories onto Vacuum Cleaner

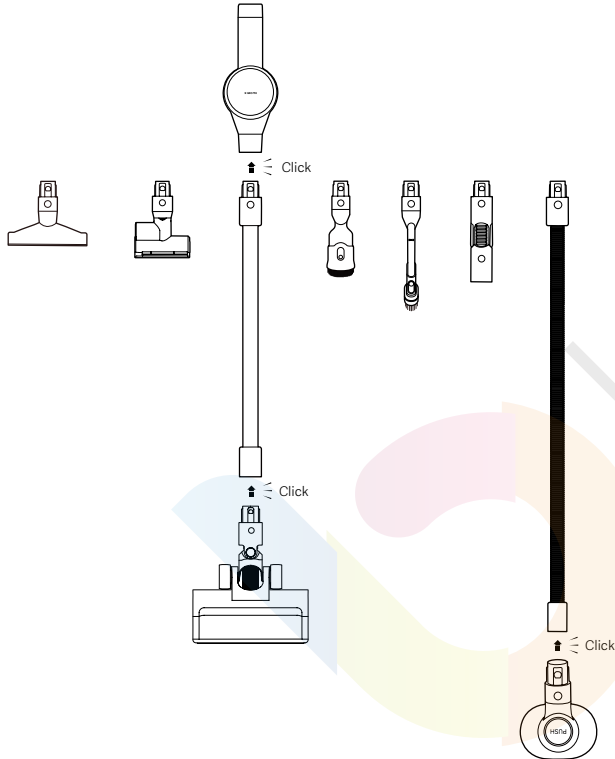

Note: Do not use the extension hose with the electric brush bar or mini electric brush.

Installing Vacuum Cleaner Wall Mount and Accessory Wall Mount

1. **Choose location:** Find a cool, dry place with an electrical outlet nearby and free from obstructions like wires or pipes on the wall. Ensure both the vacuum cleaner wall mount and accessory wall mount are installed at a height of 120 cm from the ground. Maintain a recommended spacing of 15 cm between the two wall mounts.
2. **Drill holes:** Make marks on the wall respectively according to the holes on the two wall mounts. Use a power drill with a 5 mm drill bit to drill holes approximately 40 mm deep in each marked position, and then insert a wall plug into each hole.
3. **Install wall mounts:** Align the holes in the wall mounts with the holes drilled in the wall, and then use the self-tapping screw to secure the wall mounts to the wall.

Notes:

- Please strictly follow the height requirements as illustrated when installing the two wall mounts to avoid affecting storage.
- The accessory wall mount can hold 4 accessories.

Accessory Wall Mount Installation

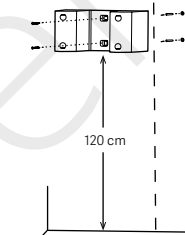

Vacuum Cleaner Wall Mount Installation

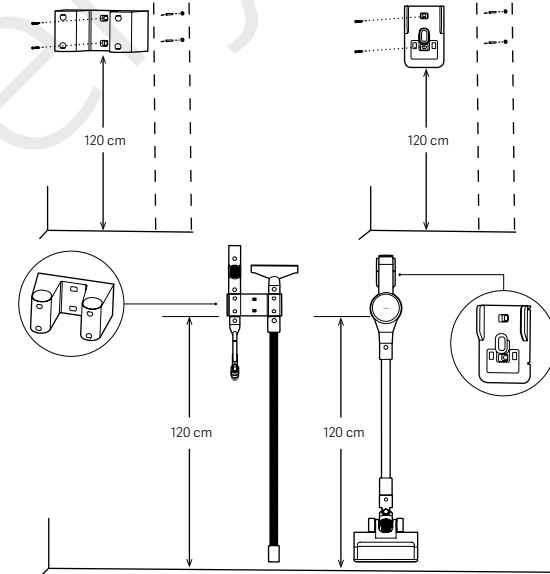

Charging

Charging Vacuum Cleaner

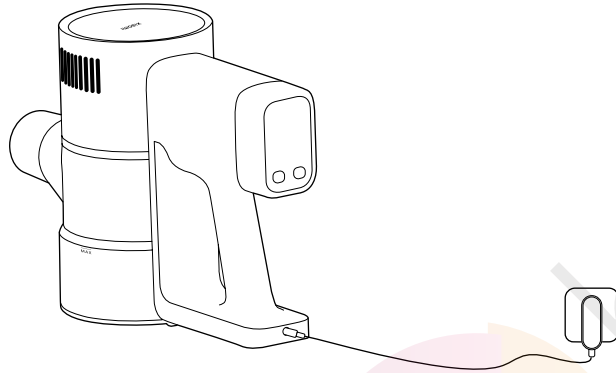

Charging Vacuum Cleaner via Wall Mount

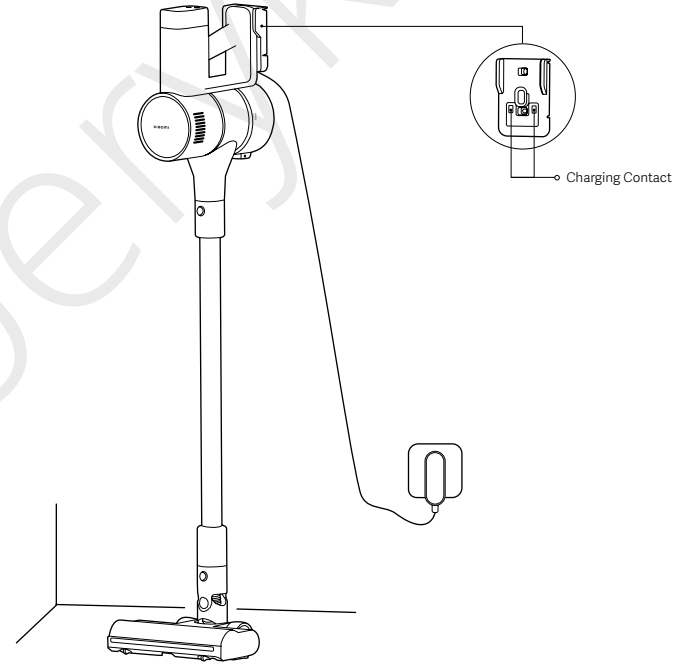

Notes:

- Fully charge the vacuum cleaner before using it for the first time. This will take about 3.5 hours.
- The vacuum cleaner cannot be used while charging.
- Once fully charged, the vacuum cleaner will enter eco mode with its battery level indicator off.
- Vacuuming in turbo mode for a prolonged period will cause the battery to heat up, which may increase charging time. It is recommended to cool the vacuum cleaner down for 60 minutes before charging it.

How to Use

Electric Brush Bar (Equipped with Headlight)

Suitable for cleaning marble floors, wooden floors, and short-pile carpets.

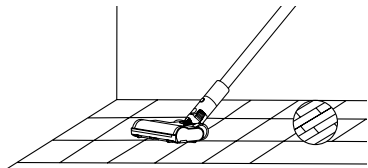

2-in-1 Crevice Brush

Suitable for cleaning crevices in corners, sofas, and car interiors.

Note: To avoid potential safety hazards, do not expose the vacuum cleaner to direct sunlight or store it in environments with high temperatures like inside a car in summer.

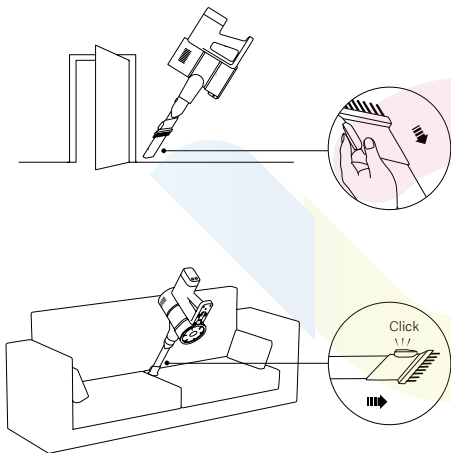

2-in-1 Wide Brush

Suitable for cleaning keyboards, curtains, sofas, ceilings, tables, counters, and car interiors.

Note: To avoid potential safety hazards, do not expose the vacuum cleaner to direct sunlight or store it in environments with high temperatures like inside a car in summer.

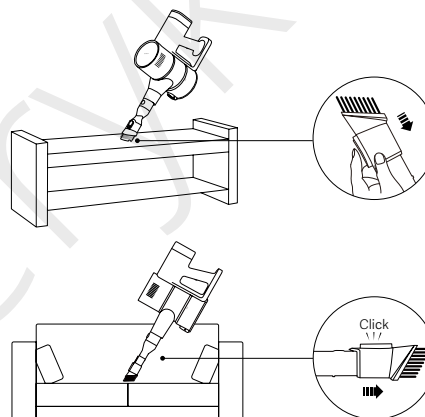

Sofa Brush

Suitable for removing dust from fabrics such as sofas and mattresses.

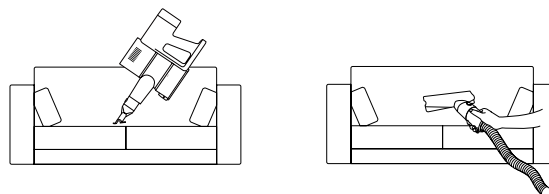

Bendable Tube

Use with electric brush bar, mini electric brush, and extension rod to change cleaning angle.

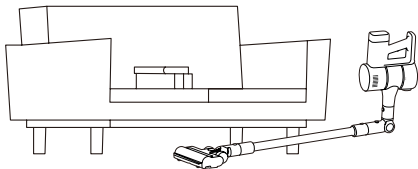

Extension Hose

Use with 2-in-1 crevice brush, 2-in-1 wide brush, sofa brush, and pet brush to effectively increase cleaning distance.

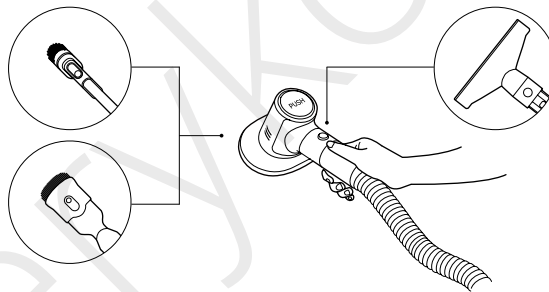

Mini Electric Brush

Suitable for cleaning pet hair and stubborn dirt from fabrics such as mattresses and sofas.

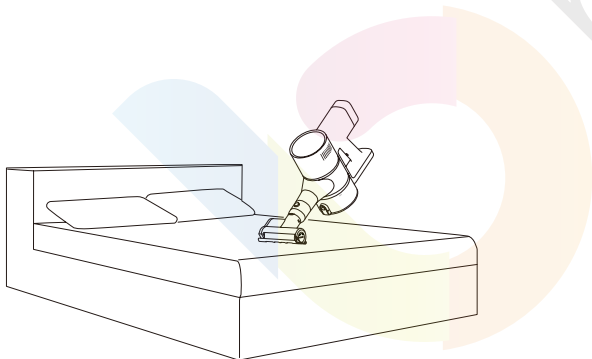

Pet Brush

Suitable for pet hair removal.

- It is recommended to gently brush and clean the pet hair in the direction of hair growth.
- To expand the movement space, connect the extension hose to the vacuum cleaner.
- If pet hair accumulates on the bristles of the pet brush, remove the pet brush from the pet and press the PUSH button to clean the hair from the bristles.

Cautions:

- It is recommended to use eco mode or auto mode.
- Stop brushing the pet immediately if your pet shows signs of displeasure or discomfort.
- When brushing the pet, ensure the safety of people and pets to avoid causing hazards.

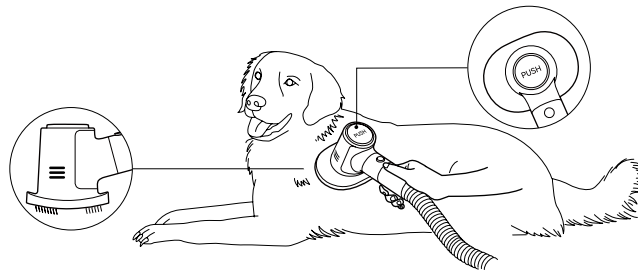

Care & Maintenance

Cautions:

- Before care and maintenance, unplug the power supply and make sure the vacuum cleaner is turned off.
- Always use genuine parts to ensure normal operation and to keep warranty valid.
- If a blockage occurs in the filter, pre-filter, post-filter, extension rod, bendable tube, extension hose, 2-in-1 crevice brush, 2-in-1 wide brush, sofa brush, or pet brush, the vacuum cleaner will stop working. Turn off and clean the vacuum cleaner before using it again.
- If the electric brush bar or mini electric brush gets blocked, it will stop working but the vacuum cleaner itself will not. Please turn the vacuum cleaner off to clean the electric brush bar or mini electric brush, and then use it again.
- Before cleaning, remove the brush head from the vacuum cleaner to prevent accidentally turning on the vacuum cleaner, which may cause injury.
- If the vacuum cleaner will not be used for an extended period, fully charge it and disconnect it from the power, and then store it in a cool, low-humidity environment away from direct sunlight.
- To avoid over-discharging the battery, recharge the vacuum cleaner at least once every three months.

Cleaning Vacuum Cleaner

Wipe clean the vacuum cleaner with a soft, dry cloth.

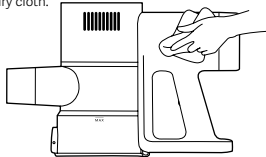

Cleaning Dust Compartment

The vacuum cleaner's cleaning ability will be reduced if the dust compartment is filled to the "MAX" mark. To regain performance, empty the dust compartment: Hold the dust compartment over a trash bin, and then press the dust release button to empty the contents.

Caution: Before cleaning the dust compartment, turn off the vacuum cleaner, disconnect the power supply, and remove the extension rod.

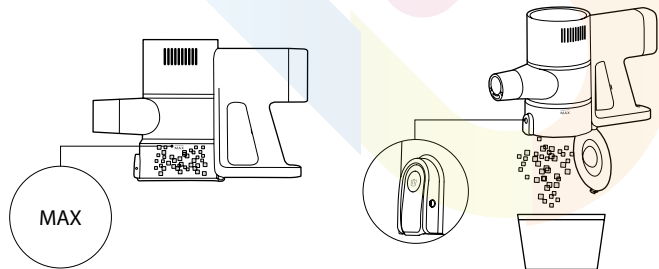

Cleaning Filter Assembly

1. Release the dust compartment latch to remove the dust compartment outwards as illustrated.

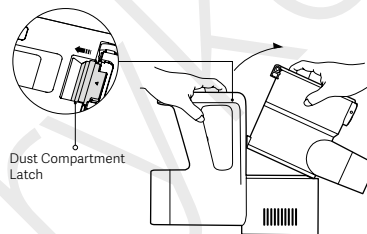

1

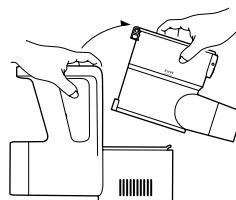

2

2. Remove the pre-filter, lift the filter handle, and rotate the filter to  to remove it as illustrated.

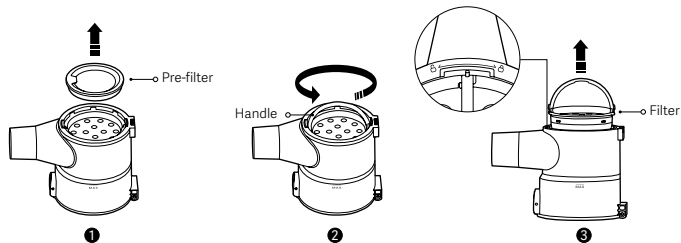

3. Rotate the post-filter counterclockwise to  to remove it.

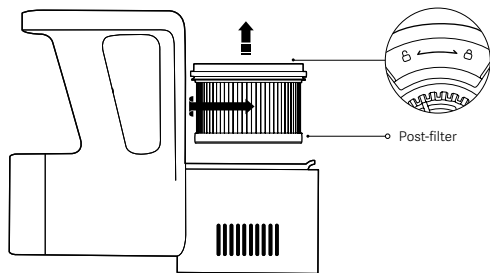



4. Rinse the filter, pre-filter, and post-filter, and then set them aside to fully dry for at least 24 hours.

Notes:

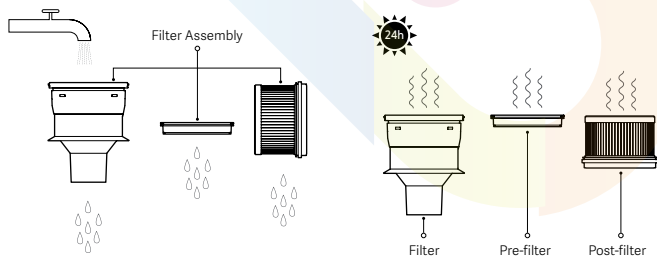
- Never soak the pre-filter and post-filter.
- When cleaning the post-filter, rinse it repeatedly and tap its edge lightly to remove any dust and debris until it is clean.
- Do not clean the pre-filter and post-filter with hands, a brush, or a sharp object to prevent damage.
- If the suction power is still significantly reduced after the pre-filter and post-filter are cleaned, try to purchase and replace them with genuine ones.



Installing Filter Assembly

1. Align the filter handle with  and place the filter vertically into the dust compartment.
2. Hold the filter handle, and rotate the filter to .
3. Install the pre-filter with its front side up.
4. Place the post-filter into the vacuum cleaner and rotate it to .
5. Reinstall the dust compartment and make sure it is secured in place.

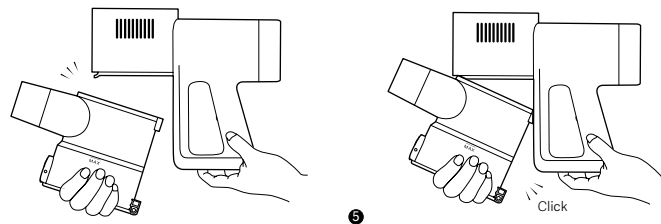
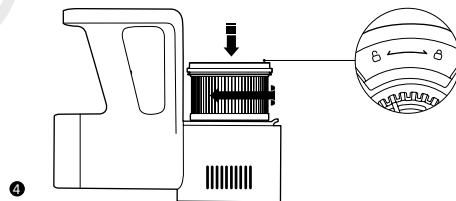
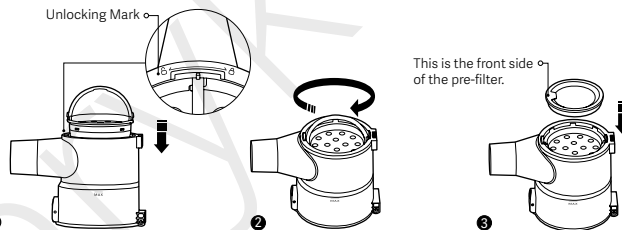

Cleaning Electric Brush Bar

1. Place the electric brush bar upside down, press the roller brushbar release button, and take out the roller brushbar.

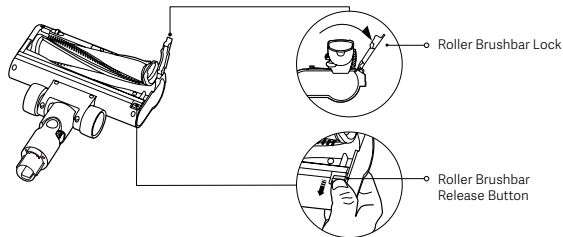

2. Wipe clean the suction opening and the transparent cover with a dry cloth or paper towel.
3. Cut any hair tangled around the roller brushbar, and then clean it.

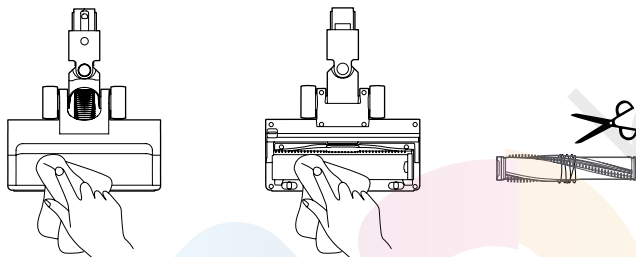

4. Reinstall the roller brushbar in the correct direction as illustrated, and then press the roller brushbar lock to secure the roller brushbar into place.

Caution: Do not clean the electric brush bar with water as it has a built-in motor.

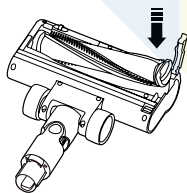

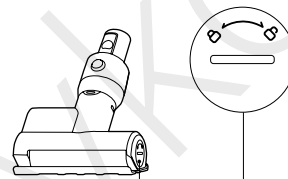

Cleaning Mini Electric Brush

1. Rotate the roller brushbar to  with a suitable tool to remove it.

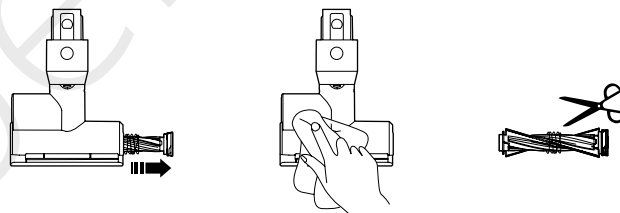

2. Wipe clean the suction opening and the transparent cover with a dry cloth or paper towel.
3. Cut any hair tangled around the roller brushbar, and then clean it.



4. Reinstall the roller brushbar and rotate it to .

Caution: Do not clean the mini electric brush with water as it has a built-in motor.

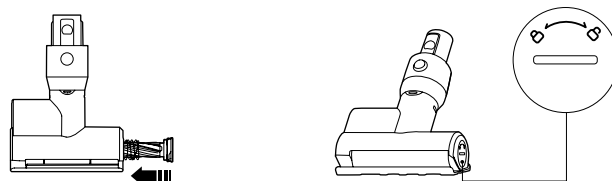



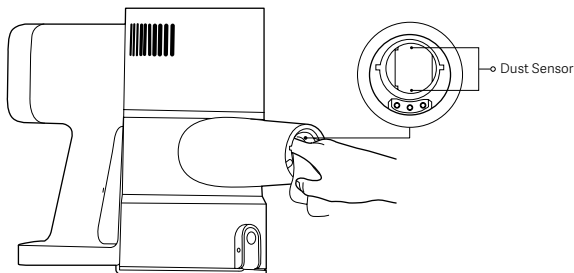

Cleaning Dust Sensor

Wipe clean the dust sensor with a dry cloth or tissue.



Troubleshooting

If the vacuum cleaner malfunctions, the display will show the corresponding error indication. Refer to the table below for solutions.

Error	Possible Cause	Solution
	The air duct is blocked.	Check and clean the dust compartment, filter, pre-filter, post-filter, extension rod, extension hose, or brush head.
	The roller brushbar is tangled.	Check and clean the roller brushbar.
	The battery overheat protection is triggered.	Wait until the battery temperature returns to normal, and then try to use it again.
	The screen displays the error code E0, E1, E2, E3, or E4.	Contact the after-sales service team.
	The dust sensor is dirty.	Wipe clean the dust sensor and try again.

Common Issues

Common Issue	Possible Cause	Solution
The vacuum cleaner does not work.	The battery is depleted.	Charge the vacuum cleaner before use.
	The suction opening, air duct, pre-filter, or post-filter is blocked.	Check and clean immediately.
	The filter, pre-filter, or post-filter is not installed in place.	Check and install in place.
The suction power reduces.	The battery overheat protection is triggered.	Wait until the battery temperature returns to normal, and then try to use it again.
	The dust compartment is full, or the pre-filter or the post-filter is blocked.	Check and clean immediately.
	The brush head is tangled.	Clean the brush head.
The battery life is short.	The battery is not fully charged.	Charge the vacuum cleaner before use.
	The dust compartment is full, or the pre-filter or the post-filter is blocked.	Check and clean immediately.
	The brush head is tangled.	Clean the brush head.
The roller brushbar does not rotate.	The roller brushbar is stuck by foreign objects.	Remove any foreign object, and then try again.
	The conductive contacts on the brush head or extension rod is dirty.	Turn the vacuum cleaner off, and remove the brush head. Wipe the conductive contacts with a soft, dry cloth, and then try again.
The vacuum cleaner cannot be charged.	The power supply being used is not genuine.	Only use the genuine power supply to charge the vacuum cleaner.
The battery charges slowly.	The battery overheat protection is triggered.	Wait until the battery temperature returns to normal, and then try to use it again.

Note: If the issue persists, contact the after-sales service team.

Specifications

Xiaomi Vacuum Cleaner G30 Max

Name	Cordless Vacuum Cleaner	Model	E203
Rated Voltage	28.8 V \approx	Rated Power	700 W
Charging Voltage	35.0 V \approx	Net Weight	5.1 kg
Power Consumption	Off mode: \leq 0.5 W	Time to Enter the Condition	Off mode: \leq 20 min

Electric Brush Bar (Equipped with Headlight)

Model	E203-DS	Rated Voltage	28.8 V \approx
Rated Power	30 W		

Mini Electric Brush

Model	E203-MN	Rated Voltage	28.8 V \approx
Rated Power	10 W		

Power Supply

Manufacturer	Zhongshan Baolijin Electronic Co., Ltd.		
Model	BLJ48WF350130P-V	Average Active Efficiency	87.74%
Rated Input	100-240 V~ 50/60 Hz 1.2 A	Efficiency at Low Load (10%)	80.47%
Rated Output	35.0 V \approx 1.3 A 45.5 W	No-load Power Consumption	0.09 W

Environmental Notice

The rechargeable lithium-ion battery pack of this vacuum cleaner contains chemicals that may pollute the environment. Before disposing of the vacuum cleaner, remove the battery and then discard it at an appropriate recycling facility.

- The battery must be removed from the appliance before it is scrapped.
- The appliance must be disconnected from the supply mains when removing the battery.
- The battery is to be disposed of safely.

Cautions:

- Make sure the vacuum cleaner is disconnected from power and the battery is fully drained before removal.
- Take the removed battery to the professional recycling facility to properly dispose of it.
- Do not leave the battery in a high-temperature environment; otherwise, it may explode.
- In the event of a battery leak, avoid contact with the liquid. If the liquid enters the eyes, rinse thoroughly and seek medical attention immediately.

Steps to Remove and Install the Battery:

1. Remove the five screws from the underside of the vacuum cleaner, and then detach the lower cover and charging cable harness terminal.
2. Remove the rear cover of the vacuum cleaner and unplug the charging cable harness terminal from the circuit board.
3. Remove the display panel assembly and detach the harness terminal.
4. Remove one screw from the front cover on the vacuum cleaner and slide down to remove the front cover.
5. Remove the outer casing and unplug the harness terminal between the outer casing and the battery pack.
6. Detach the two screws connecting the battery pack to the motor cover assembly and remove the battery pack.
7. Connect and pre-secure the new battery pack to the motor cover assembly with the snap hook, and then fasten them with two screws.
8. Connect the new battery pack to the harness terminal of the outer casing, then plug it into the outer casing.
9. Slide the front cover panel upward into place and fasten it with one screw.
10. Install the charging cable harness terminal onto the circuit board, and then install the rear cover panel.
11. Connect the charging cable harness terminal to the lower cover of the vacuum cleaner and fasten them with five screws.
12. Attach the display harness terminal to the new battery pack, and then install the display panel assembly.

WARRANTY NOTICE

THIS WARRANTY GIVES YOU SPECIFIC RIGHTS, AND YOU MAY HAVE OTHER RIGHTS CONVEYED BY LAWS OF YOUR COUNTRY, PROVINCE OR STATE. INDEED, IN SOME COUNTRIES, PROVINCES OR STATES, CONSUMER LAW MAY IMPOSE A MINIMUM WARRANTY PERIOD. OTHER THAN AS PERMITTED BY LAW, XIAOMI DOES NOT EXCLUDE, LIMIT OR SUSPEND OTHER RIGHTS YOU MAY HAVE. FOR A FULL UNDERSTANDING OF YOUR RIGHTS WE INVITE YOU TO CONSULT THE LAWS OF YOUR COUNTRY, PROVINCE OR STATE.

1. LIMITED PRODUCT WARRANTY

XIAOMI warrants that the Products are free from defects in materials and workmanship under normal use and use in accordance with the respective Product user manual, during the Warranty Period. The duration and conditions related to the legal warranties are provided by respective local laws. For more information about the consumer warranty benefits, please refer to Xiaomi's official website <https://www.mi.com/global/support/warranty>.
Xiaomi warrants to the original purchaser that its Xiaomi Product will be free from defects in materials and workmanship under normal use in the period mentioned above. Xiaomi does not guarantee that the operation of the Product will be uninterrupted or error free.
Xiaomi is not liable for damages arising from non-compliance with the instructions related to the use of the Product.

2. REMEDIES

If a hardware defect is found and a valid claim is received by Xiaomi within the Warranty Period, Xiaomi will either (1) repair the product at no charge, (2) replace the product, or (3) refund the Product, excluding potential shipping costs.

3. HOW TO OBTAIN WARRANTY SERVICE

To obtain warranty service, you must deliver the Product, in its original packaging or similar packaging providing an equal degree of Product protection, to the address specified by Xiaomi. Except to the extent prohibited by applicable law, Xiaomi may require you to present proofs or proof of purchase and / or comply with registration requirements before receiving warranty service.

4. EXCLUSIONS AND LIMITATIONS

Unless otherwise stipulated by Xiaomi, this Limited Warranty applies only to the Product manufactured by or for Xiaomi and identifiable by the trademarks, trade name or "Xiaomi" or "Mi" logo. The Limited Warranty does not apply to any (a) Damage due to acts of nature or God, for example, lightning strikes, tornadoes, flood, fire, earthquake or other external causes; (b) Negligence; (c) Commercial use; (d) Alterations or modifications to any part of the Product; (e) Damage caused by use with non-Xiaomi products; (f) Damage caused by accident, abuse or misuse; (g) Damage caused by operating the Product outside the permitted or intended uses described by Xiaomi or with improper voltage or power supply; or (h) Damage caused by service (including upgrades and expansions) performed by anyone who is not a representative of Xiaomi.
It is your responsibility to backup any data, software, or other materials you may have stored or preserved on the product. It is likely that the data, software or other materials in the equipment will be lost or reformatted during the service process, Xiaomi is not responsible for such damage or loss.
No Xiaomi reseller, agent, or employee is authorized to make any modification, extension, or addition to this Limited Warranty. If any term is held to be illegal or unenforceable, the legality or enforceability of the remaining terms shall not be affected or impaired.

Except as prohibited by laws or otherwise promised by Xiaomi, the after-sales services shall be limited to the country or region of the original purchase. Products which were not duly imported and/or were not duly manufactured by Xiaomi and/or were not duly acquired from Xiaomi or a Xiaomi's official seller are not covered by the present warranties. As per applicable law you may benefit from warranties from the non-official retailer who sold the product. Therefore, Xiaomi invites you to contact the retailer from whom you purchased the product. The present warranties do not apply in Hong Kong and Taiwan.

5. IMPLIED WARRANTIES

Except to the extent prohibited by applicable law, all implied warranties (including warranties of merchantability and fitness for a particular purpose) will have a limited duration up to a maximum duration of this limited warranty. Some jurisdictions do not allow limitations on the duration of an implied warranty, so the above limitation will not be applied in these cases.

6. DAMAGE LIMITATION

Except to the extent prohibited by applicable law, Xiaomi shall not be liable for any damages caused by accidents, indirect, special or consequential damages, including but not limited to loss of profits, revenue or data, damages resulting from any breach of express or implied warranty or condition, or under any other legal theory, even if Xiaomi has been informed of the possibility of such damages. Some jurisdictions do not allow the exclusion or limitation of special, indirect, or consequential damages, so the above limitation or exclusion may not apply to you.

7. XIAOMI CONTACTS

For customers, please visit the website: <https://www.mi.com/global/support/warranty>
The contact person for the after-sale service may be any person in Xiaomi's authorized service network, Xiaomi's authorized distributors or the final vendor who sold the products to you. If in doubt please contact the relevant person as Xiaomi may identify.

Manufacturer: Xiaomi Communications Co., Ltd.
Address: #019, 9th Floor, Building 6, 33 Xi'erqi Middle Road,
Haidian District, Beijing, 100085, China
For further information, please go to www.mi.com
User Manual Version: V2.0

EU REP:
Xiaomi Technology Netherlands B.V.
Prinses Beatrixlaan 582, 2595BM, The Hague, The Netherlands
contact@support.mi.com

Importer:
Beryko s.r.o.
Pod Vinicemi 931/2, 301 00 Plzeň
www.beryko.cz



beryko



PAP



E-manual QR Code



BHR08C6EU-IB