

Hisense
life reimagined

EN

**INSTRUCTIONS FOR USE
OF A BUILT-IN
MICROWAVE OVEN**

BIM334G64DBG8



PRECAUTIONS TO AVOID POSSIBLE EXPOSURE TO EXCESSIVE MICROWAVE ENERGY

- (a) Do not attempt to operate this oven with the door open since this can result in harmful exposure to microwave energy. It is important not to break or tamper with the safety interlocks.
- (b) Do not place any object between the oven front face and the door or allow soil or cleaner residue to accumulate on sealing surfaces.
- (c) **WARNING:** If the door or door seals are damaged, the oven must not be operated until it has been repaired by a competent person.

ADDENDUM

If the apparatus is not maintained in a good state of cleanliness, its surface could be degraded and affect the lifespan of the apparatus and lead to a dangerous situation.

SPECIFICATIONS

Model	BIM334G64DBG8
Rated Voltage	230 V~ 50 Hz
Microwave Input	1450 W
Microwave Output	900 W
Grill	1100 W
Operating Frequency	2450MHz
Outside Dimensions	595mm(W)x382mm(H)x456mm(D)
Oven Capacity	34 litres
Weight	Approx. 23.2kg
Noise level	Lc < 63 dB (A)
Turntable diameter	345 mm

ENERGY CONSUMPTION

Product information for power consumption and maximum time to reach applicable low power mode.

Standby mode	0.8 W
The maximum time needed for the microwave oven to automatically reach the applicable low power mode or condition.	20 minutes

IMPORTANT SAFETY INSTRUCTIONS AND WARNINGS

To reduce the risk of fire, electric shock, injury to persons or exposure to excessive microwave oven energy when using your appliance, follow basic precautions, including the following:

1. Read and follow the specific: »PRECAUTIONS TO AVOID POSSIBLE EXPOSURE TO EXCESSIVE MICROWAVE ENERGY".
2. This appliance can be used by children aged from 8 years and above and persons with reduced physical, sensory, or mental capabilities or lack of experience and knowledge if they have been given supervision or instruction concerning use of the appliance in a safe way and understand the hazards involved. Children shall not play with the appliance. Cleaning and user maintenance shall not be made by children without supervision.
3. Keep the appliance and its cord out of reach of children less than 8 years.
4. If the supply cord is damaged, it must be replaced by the manufacturer, its service agent, or similarly qualified persons to avoid a hazard.
5. **WARNING:** Ensure that the appliance is switched off before replacing the lamp to avoid the possibility of electric shock.
6. **WARNING:** It is hazardous for anyone other than a competent person to carry out any service or repair operation that involves the removal of a cover which gives protection against exposure to microwave energy.
7. **WARNING:** Liquids and foods must not be heated in sealed containers since they are liable to explode.
8. When heating food in plastic or paper containers, keep an eye on the oven due to the possibility of ignition.

9. Only use utensils that are suitable for use in microwave ovens.
10. If smoke is emitted, switch off or unplug the appliance and keep the door closed to stifle any flames.
11. Microwave heating of beverages can result in delayed eruptive boiling; therefore, care must be taken when handling the container.
12. The contents of feeding bottles and baby food jars shall be stirred or shaken and the temperature checked before consumption, to avoid burns.
13. Eggs in their shell and whole hard-boiled eggs should not be heated in microwave ovens since they may explode, even after microwave heating has ended.
14. Details for cleaning door seals, cavities, and adjacent parts.
15. The oven should be cleaned regularly, and any food deposits removed.
16. Failure to maintain the oven in a clean condition could lead to deterioration of the surface that could adversely affect the life of the appliance and possibly result in a hazardous situation.
17. Only use the temperature probe recommended for this oven. (For ovens provided with a facility to use a temperature-sensing probe.)
18. The microwave oven must be operated with the decorative door open. (For ovens with a decorative door.)
19. This appliance is intended to be used in household and similar applications such as:
 - staff kitchen areas in shops, offices and other working environments.
 - by clients in hotels, motels and other residential type environments.

- farm houses.
 - bed and breakfast type environments.
20. The microwave oven is intended for heating food and beverages. Drying of food or clothing and heating of warming pads, slippers, sponges, damp cloth and similar may lead to risk of injury, ignition, or fire.
 20. Metallic containers for food and beverages are not allowed during microwave cooking.
 21. The appliance shall not be cleaned with a steam cleaner.
 22. The appliance must not be installed behind a decorative door to avoid overheating. (This is not applicable for appliances with decorative door.)
 23. The microwave oven is intended to be used built in.
 24. The appliance must be operated with any cabinet door open.
 25. Care should be taken not to displace the turntable when removing containers from the appliance. (For fixed appliances and built-in appliances being used equal or higher than 900mm above the floor and having detachable turntables. But this is not applicable for appliances with horizontal bottom hinged door.)
 26. Surface of a storage drawer can get hot.
 27. Do not use harsh abrasive cleaners or sharp metal scrapers to clean the oven door glass since they can scratch the surface, which may result in shattering of the glass.
 28. **WARNING:** The appliance and its accessible parts become hot during use. Care should be taken to avoid touching heating elements. Children less than 8 years of age shall be kept away unless continuously supervised.
 29. During and after use the appliance becomes hot. Care should be taken to avoid touching heating elements inside the oven.

30. WARNING: Accessible parts may become hot during and after use. Young children should be kept away.
31. WARNING: When the appliance is operated in the combination mode, children should only use the oven under adult supervision due to the temperatures generated.

**READ CAREFULLY AND KEEP FOR FUTURE
REFERENCE
HOUSEHOLD USE ONLY
(NOT FOR COMMERCIAL USE)**

TO REDUCE THE RISK OF INJURY TO PERSONS GROUNDING INSTALLATION

DANGER

Electric Shock Hazard

Touching some of the internal components can cause serious personal injury or death. Do not disassemble this appliance.

WARNING

Electric Shock Hazard

Improper use of the grounding can result in electric shock.

Do not plug into an outlet until appliance is properly installed and grounded.

This appliance must be grounded. In the event of an electrical short circuit, grounding reduces the risk of electric shock by providing an escape wire for the electric current.

This appliance is equipped with a cord having a grounding wire with a grounding plug. The plug must be plugged into an outlet that is properly installed and grounded.

Consult a qualified electrician or serviceman if the grounding instructions are not completely understood or if doubt exists as to whether the appliance is properly grounded.

If it is necessary to use an extension cord, use only a 3-wire extension cord.

1. A short power-supply cord is provided to reduce the risks resulting from becoming entangled in or tripping over a longer cord.
2. If a long cord set or extension cord is used:
 - 1) The marked electrical rating of the cord set, or extension cord should be at least as great as the electrical rating of the appliance.
 - 2) The extension cord must be a grounding-type 3-wire cord.
 - 3) The long cord should be arranged so that it will not drape over the countertop or tabletop where it can be pulled on by children or tripped over unintentionally.

CLEANING

Be sure to unplug the appliance from the power supply.

1. Clean the cavity of the oven after using with a slightly damp cloth.
2. Clean the accessories in the usual way in soapy water.
3. The door frame and seal and neighbouring parts must be cleaned carefully with a damp cloth when they are dirty.
4. Do not use harsh abrasive cleaners or sharp metal scrapers to clean the oven door glass since they can scratch the surface, which may result in shattering of the glass.

Aqua clean program:

For easier cleaning of the cavity walls that the food cooked can touch: Place half a lemon in a bowl, add 300ml (1/2 pint) water and heat on 100% microwave power for 10 minutes. Wipe the oven clean using a soft, dry cloth.

UTENSILS

CAUTION

Personal Injury Hazard

It is hazardous for anyone other than a competent person to carry out any service or repair operation that involves the removal of a cover which gives protection against exposure to microwave energy.

See the instructions on "Materials you can use in microwave oven or to be avoided in microwave oven." There may be certain non-metallic utensils that are not safe to use for microwaving. If in doubt, you can test the utensil in question following the procedure below.

Utensil Test:

1. Fill a microwave-safe container with 1 cup of cold water (250ml) along with the utensil in question.
2. Cook on maximum power for 1 minute.
3. Carefully feel the utensil. If the empty utensil is warm, do not use it for microwave cooking.
4. Do not exceed 1 minute cooking time.

Materials you can use in microwave oven:

Utensils	Remarks
Browning dish	Follow manufacturer's instructions. The bottom of browning dish must be at least 3/16 inch (5mm) above the turntable. Incorrect usage may cause the turntable to break.
Dinnerware	Microwave-safe only. Follow manufacturer's instructions. Do not use cracked or chipped dishes.
Glass jars	Always remove lid. Use only to heat food until just warm. Most glass jars are not heat resistant and may break.
Glassware	Heat-resistant oven glassware only. Make sure there is no metallic trim. Do not use cracked or chipped dishes.
Oven cooking bags	Follow manufacturer's instructions. Do not close with metal tie. Make slits to allow steam to escape.
Paper plates and cups	Use for short-term cooking/warming only. Do not leave oven unattended while cooking.
Paper towels	Use to cover food for reheating and absorbing fat. Use with supervision for a short-term cooking only.
Parchment paper	Use as a cover to prevent splattering or a wrap for steaming.
Plastic	Microwave-safe only. Follow the manufacturer's instructions. Should be labeled "Microwave Safe". Some plastic containers soften, as the food inside gets hot. "Boiling bags" and tightly closed plastic bags should be slit, pierced or vented as directed by package.
Plastic wrap	Microwave-safe only. Use to cover food during cooking to retain moisture. Do not allow plastic wrap to touch food.
Thermometers	Microwave-safe only (meat and candy thermometers).
Wax paper	Use as a cover to prevent splattering and retain moisture.

Materials to be avoided in microwave oven:

Utensils	Remarks
Aluminum tray	May cause arcing. Transfer food into microwave-safe dish.
Food carton with metal handle	May cause arcing. Transfer food into microwave-safe dish.
Metal or metal-trimmed utensils	Metal shields the food from microwave energy. Metal trim may cause arcing.
Metal twist ties	May cause arcing and could cause a fire in the oven.
Paper bags	May cause a fire in the oven.
Plastic foam	Plastic foam may melt or contaminate the liquid inside when exposed to high temperature.
Wood	Wood will dry out when used in the microwave oven and may split or crack.

NAMES OF OVEN PARTS AND ACCESSORIES

Remove the oven and all materials from the carton and oven cavity.
Your oven comes with the following accessories:

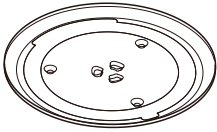

Glass Tray



Turntable Ring Assembly



Instruction Manual

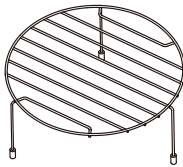

Higher Wire Rack (For grilling, e.g., steaks, sausages and for toasting bread. As a support for shallow dishes.)



Turntable Shaft

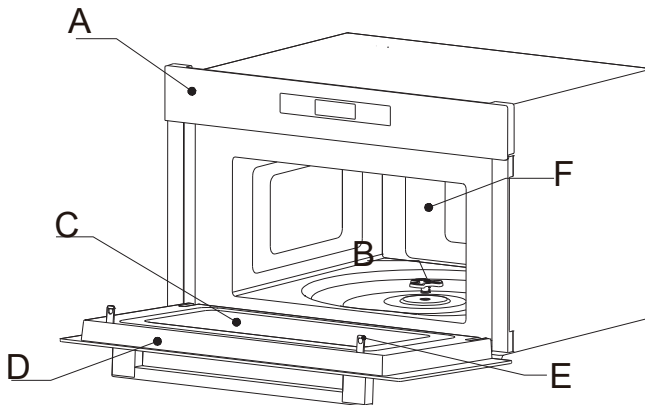

- A) Control panel
- B) Turntable shaft
- C) Observation window

- D) Door assembly
- E) Safety interlock system
- F) Oven cavity

INSTALLATION AND CONNECTION

1. This appliance is only intended for domestic use.
2. This oven is intended for built-in use only. It is not intended for counter-top use or for use inside a cabinet.
3. Please observe the special installation instructions.
4. The appliance can be installed in a 60cm wide wall-mounted cupboard.
5. The appliance is fitted with a plug and must only be connected to a properly installed earthed socket.
6. The mains voltage must correspond to the voltage specified on the rating plate.
7. The socket must be installed and connecting cable must only be replaced by a qualified electrician. If the plug is no longer to accessible following installation, an all-pole disconnecting device must be present on the installation side with a contact gap of at least 3mm.
8. Adapters, multi-way strips and extension leads must not be used. Overloading can result in a risk of fire.
9. Don't use under the work surface and that it must not be subject to spillage from containers onto surfaces under which the appliance is installed.
10. Means for disconnection must be incorporated in the fixed wiring in accordance with the wiring rules.
11. A disconnection incorporated in the fixed wiring is to be provided.

The accessible surface may be hot during and after operation.



TURNTABLE INSTALLATION

Cleaning the cooking compartment and putting the turntable in place. For new installations, make sure all packaging and shipping tape has been removed from the turntable shaft. Before using the appliance to prepare food for the first time, you will need to put the turntable in place correctly. You must clean the cooking compartment and accessories.

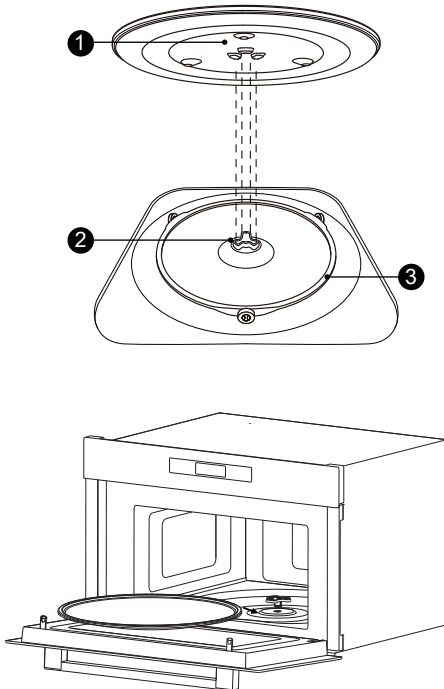

How to put the turntable in place:

1. Place the turntable ring assembly (3) into the recess in the cooking compartment.
2. Place the glass tray (1) on the turntable ring assembly (3). Fit the raised, curved lines in the center of the glass tray bottom between the three spokes of the shaft. Make sure that the glass tray (1) engages in the turntable shaft (2) in the center of the cooking compartment floor. The rollers on the shaft should fit inside the turntable bottom ridge.

Note :

1. Never use the appliance without the turntable. Make sure that it is properly engaged. The turntable can turn clockwise or anti clockwise.
2. Never place the glass tray upside down. The glass tray should never be restricted.
3. Both glass tray and turntable ring assembly must always be used during cooking.
4. Some food and containers of food are always placed on the glass tray for cooking.
5. Never restrict the movement of the turntable.
6. If glass tray or turntable ring assembly cracks or breaks, contact your nearest authorized service center.

BUILT-IN OVEN INSTALLATION

The dimensions are in mm.

The units into which the appliance is fitted must be heat-resistant up to 95°C.

The minimum installation height is 850mm.

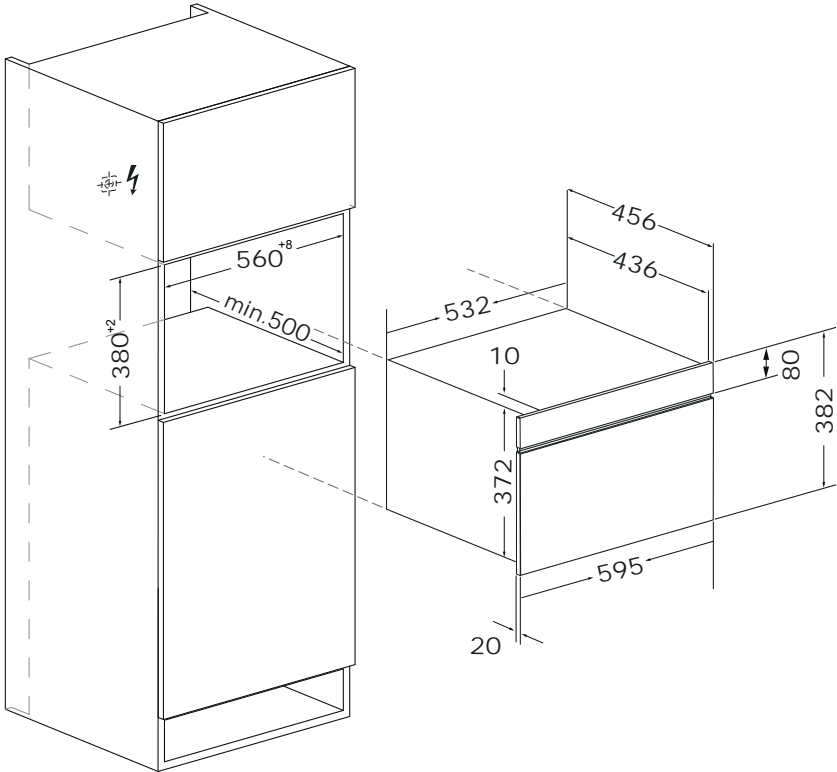

WARNING: Do not hold or carry the appliance by the door handle. The door handle cannot hold the weight of the appliance and may break off.

1. Carefully push the microwave into the box, making sure that it is in the center.
2. Open the door and fasten the microwave with the screws that were supplied.
3. Fully insert the appliance and center it.
4. Do not kink the connecting cable.
5. Screw the appliance into place.

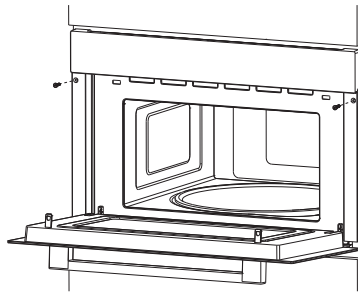

IMPORTANT INFORMATION IF OVEN HAS PLUG

The appliance is fitted with a plug and must only be connected to a properly installed earthed socket. Only a qualified electrician who takes the appropriate regulations into account may install the socket or replace the connecting cable. If the plug is no longer accessible following installation, an all-pole isolating switch must be present on the installation side with a contact gap of at least 3 mm. Contact protection must be ensured by the installation. Fuse protection: see instructions for use-technical data.

IMPORTANT INFORMATION IF OVEN DOESN'T HAVE PLUG

The appliance is designed to be permanently installed with a three-pin power cord and may only be connected by a licensed expert in accordance with the connection diagram.

Only a qualified electrician who takes the relevant regulations into account may replace the power cord. Do not use multiple plugs, power strips or extensions. Overloading causes a risk of fire.

If the connection is no longer accessible following installation, an all-pin isolating switch with a contact gap of at least 3 mm must be provided.

Connect the wires of the mains power cord in accordance with the following color coding:

Green and yellow	Earth wire (E) ⊕
Blue	Neutral wire (N)
Brown	Live (L)

Great Britain and Australia:

Do not connect the appliance using a 13 A plug or protect it with a 13 A fuse. The appliance must be protected using a fuse that is rated 16 A or higher. The appliance must be disconnected from the power supply during all installation work. When the appliance is installed, protection must be provided against accidental contact in the future.

CONTROL PANEL

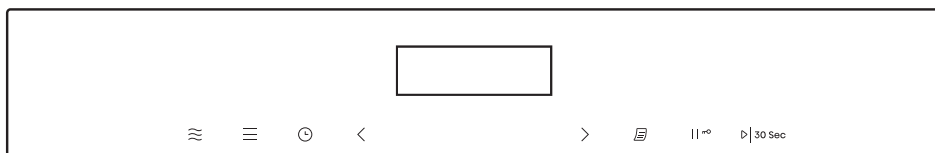

 Microwave

 Function

 Clock/Kitchen Timer

 Preset Programs







 Lock/Cancel

 30 Sec Start/+30Sec./Confirm

  Parameter adjustment

OPERATION





1. Setting the Clock

- (1) Touch “  ” once and then “00:00” will display.
- (2) Touch “  ” or “  ” to set the hour figures.
- (3) Touch “  ” to confirm.
- (4) Touch “  ” or “  ” to set the minute figures.
- (5) Touch “  ” to confirm.

Notes:

- (1) The clock is a 24-hour display. If the clock is not set, it would not work when powered.
- (2) To reset the clock, please repeat step 1 to step 5.





2. Setting the Kitchen Timer

- (1) Touch “  ” twice and then “00:00” will display.
- (2) Touch “  ” or “  ” to set the time. The maximum time value is “95:00”.
- (3) Touch “  ” to confirm. The timer starts counting down.





Note: The kitchen timer is a timer.

3. Microwave Cooking

Power Level	100%	80%	50%	30%	10%
Display	P10	P8	P5	P3	P1





- (1) In standby mode, touch “  ” once and then “P10” will display.
- (2) Touch “  ” repeatedly to adjust the power level, 5 power levels are available.
- (3) Touch “  ” or “  ” to set the cooking time. The maximum time value is “95:00”.
- (4) Touch “  ” to start cooking.

4. Grill Cooking

- (1) Touch “  ” once and then “G-1” will display.
- (2) Touch “  ” or “  ” to set the cooking time. The maximum time value is “95:00”.
- (3) Touch “  | 30 Sec ” to start grilling.

Note: The buzzer will sound to remind you to turn the food over during grilling.
If no operation, the oven will continue working.





5. Combination Cooking

- (1) Touch “  ” once and then “G-1” will display. Touch “  ” repeatedly to choose the combination cooking, and “C-1”, “C-2” will display in order.
- (2) Touch “  ” or “  ” to set the cooking time. The maximum time value is “95:00”.
- (3) Touch “  | 30 Sec ” to start cooking.

Note: Combination instructions





C-1	Micro 55%	Grill 45%
C-2	Micro 36%	Grill 64%

6. Defrost by Weight

- (1) Touch “  ” twice and then the screen will display “0.1kg”.
- (2) Touch “  ” or “  ” to set the weight of the food. The range of weight is 0.1-2.0kg.
- (3) Touch “  | 30 Sec ” to start defrosting.





Note: The buzzer will sound to remind you to turn the food over during defrosting.
If no operation, the oven will continue working.

7. Defrost by Time

- (1) Touch “  ” three times and then the screen will display “1:00”.
- (2) Touch “  ” or “  ” to set the time. The maximum defrosting time is “95:00”.
- (3) Touch “  | 30 Sec ” to start defrosting.

Note: The buzzer will sound to remind you to turn the food over during defrosting.
If no operation, the oven will continue working.

8. Quick start

- (1) In standby mode, touch “  30 Sec ” to cook food at 100% power level for 30 seconds. Each touch on the same key can increase 30 seconds and the maximum time value is “95:00”.
- (2) In standby mode, touch “  ” once, and then touch “  ” or “  ” to set a cooking time with 100% power. Touch “  30 Sec ” to start cooking.

Note: In cooking state, each one more touch on “  30 Sec ” can increase the cooking time by 30 seconds (except defrost by weight, the multi-stage cooking and the auto menu).

9. Lock Function for Children

You can use this function to prevent children from accidentally turning the oven on.

To activate the lock:

In standby mode, touch and hold “  ” for three seconds. A beep sounds and the locked icon will display.







To deactivate the lock:

In the locked state, touch and hold “  ” for three seconds. A beep sounds.

10. Inquire function

If the clock has been set, the current time will display for three seconds by touching “  ” in the cooking state.

11. Preset Programs

- (1) In standby mode, touch “  ” or “  ” once, the screen will display “A-1”.
- (2) Touch “  ” repeatedly to choose the menu you need.
The 8 auto menus are available.
- (3) Touch “  ” or “  ” to set the weight of the food.
- (4) Touch “  30 Sec ” to start cooking.

Note: For menu "A-7", please skip the step (3).

Auto menu Chart

Menu	Weight(g)	Display	Power
A-1 POTATO	1 (about 230g)	1	P10
	2 (about 460g)	2	
	3 (about 690g)	3	
A-2 MEAT	150g	150g	P8
	300g	300g	
	450g	450g	
	600g	600g	
A-3 FISH	150g	150g	P8
	250g	250g	
	350g	350g	
	450g	450g	
	650g	650g	
A-4 VEGETABLE	150g	150g	P10
	350g	350g	
	500g	500g	
A-5 BEVERAGE	1 cup(240g)	1	P10
	2 cups(480g)	2	
	3 cups(720g)	3	
A-6 PASTA	50g(with 450g cold water)	50g	P8
	100g(with 800g cold water)	100g	
	150g(with 1200g cold water)	150g	
A-7 POPCORN	100g	100g	P10
A-8 PIZZA	200g	200g	P10/G-1
	400g	400g	

Trouble shooting

Normal	
Microwave oven interfering TV reception	Radio and TV reception may be interfered when microwave oven operating. It is similar to the interference of small electrical appliances, like mixer, vacuum cleaner, and electric fan. It is normal.
Dim oven light	In low power microwave cooking, oven light may become dim. It is normal.
Steam accumulating on door, hot air out of vents	In cooking, steam may come out of food. Most will get out from vents. But some may accumulate on cool place like oven door. It is normal.
Oven started accidentally with no food in.	It is forbidden to run the unit without any food inside. It is very dangerous.

Trouble	Possible Cause	Remedy
Oven cannot be started.	(1) Power cord is not plugged in tightly.	Unplug. Then plug again after 10 seconds.
	(2) Fuse blowing or circuit breaker works.	Replace fuse or reset circuit breaker (repaired by professional personnel of our company)
	(3) Trouble with outlet.	Test outlet with other electrical appliances.
Oven does not heat.	(4) Door is not closed well.	Close door well.



According to Waste of Electrical and Electronic Equipment (WEEE) directive, WEEE should be separately collected and treated. If at any time in future, you need to dispose of this product please do NOT dispose of this product with household waste. Please send this product to WEEE collecting points where available.

global.hisense.com