

# SENCOR®

SWK 0800GY



## DOUBLE WALL U-SHAPE ELECTRIC KETTLE

Translation of the original manual



**SENCOR®**

**SWK 0800GY**



**A**

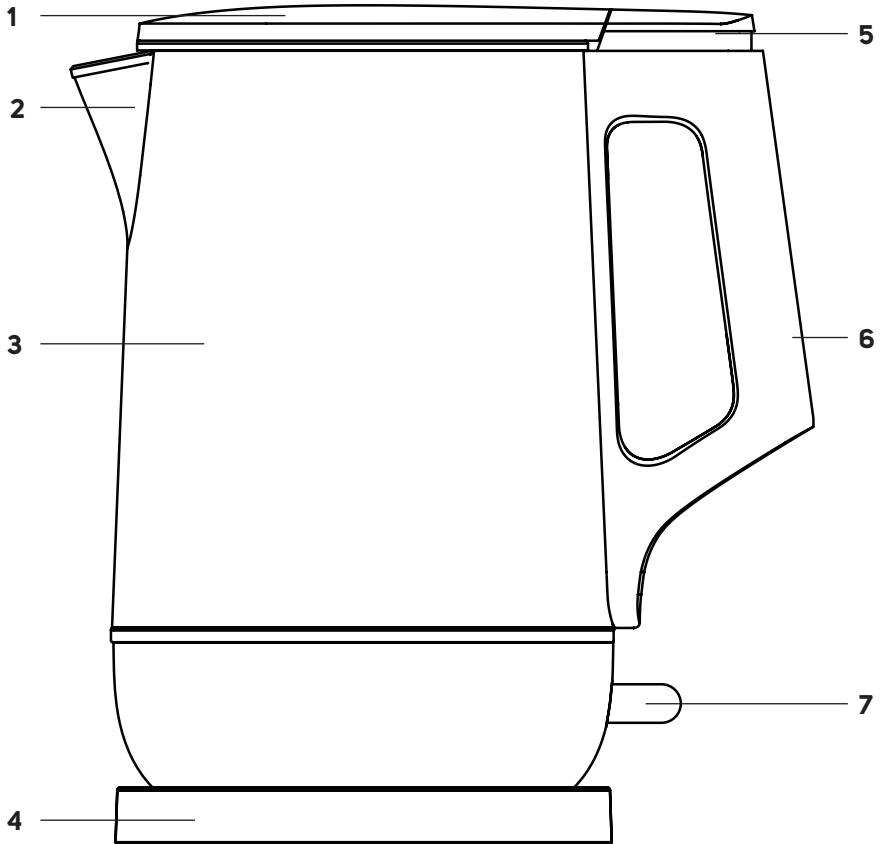

**EN****DESCRIPTION OF THE APPLIANCE**

- A1** Lid
- A2** Spout
- A3** Body of the kettle with a watermark inside
- A4** Base stand with central connector
- A5** Open lid button
- A6** Handle
- A7** On/Off switch

**SK****POPIS SPOTREBIČA**

- A1** Veko
- A2** Vúlevka
- A3** Telo kanvice s vodoznakom vnútri
- A4** Podstavec so stredovým konektorom
- A5** Tlačidlo na otvorenie veka
- A6** Rukoväť
- A7** Spínač zapnutia/vypnutia

**PL****OPIS URZĄDZENIA**

- A1** Lejek
- A2** Lejek
- A3** Korpus dzbanka ze znacznikiem poziomu wody w środku
- A4** Podstawa z centralnym złączem
- A5** Przycisk do otwarcia pokryw
- A6** Uchwyt
- A7** Wyłącznik włączenia/wyłączenia

**HR****OPIS UREĐAJA**

- A1** Poklopac
- A2** Grič
- A3** Kućište kuhala s unutarnjim oznakama razine vode
- A4** Postolje sa središnjim priključkom
- A5** Tipka za otvaranje poklopca
- A6** Ručka
- A7** Prekidač za uključivanje/isključivanje

**CZ****POPIS SPOTŘEBIČE**

- A1** Víko
- A2** Vúlevka
- A3** Tělo konvice s vodoznakem uvnitř
- A4** Podstavec se středovým konektorem
- A5** Tlačítko k otevření víka
- A6** Rukojeť
- A7** Spínač zapnutí/vypnutí

**HU****A KÉSZÜLÉK RÉSZEI**

- A1** Fedél
- A2** Kiöntő csőr
- A3** A vízforraló háza belül a szintjelzővel
- A4** Talp, középsősatlakozóval
- A5** Fedélnyitó gomb
- A6** Fogantyú
- A7** Be/ki kapcsoló

**RU****ОПИСАНИЕ ЭЛЕКТРОПРИБОРА**

- A1** Крышка
- A2** Носик
- A3** Корпус чайника с метками уровня воды внутри
- A4** Подставка с центральным разъемом
- A5** Кнопка открытия крышки
- A6** Ручка
- A7** Переключатель включения/выключения

**GR****ΠΕΡΙΓΡΑΦΗ ΤΗΣ ΣΥΣΚΕΥΗΣ**

- A1** Καπάκι
- A2** Στόμιο
- A3** Σώμα του βραστήρα με σήμανση ποσότητας νερού εσωτερικά
- A4** Βάση με κεντρικό σύνδεσμο
- A5** Κομπί για το άνοιγμα του καπακιού
- A6** Λαβή
- A7** Κομπί ενεργοποίησης/απενεργοποίησης

1

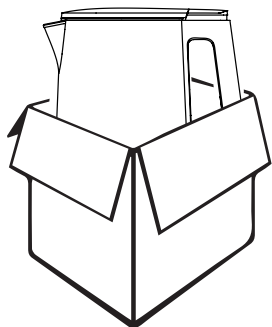

2

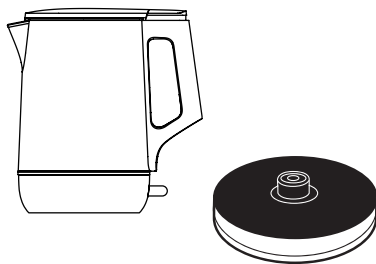

EN - BEFORE FIRST USE / CZ - PŘED PRVNÍM POUŽITÍM / SK - PRED PRVÝM POUŽITÍM / HU - AZ ELSŐ HASZNÁLTÁBA VÉTEL ELŐTT  
/ PL - PRZED PRZYSTĄPIENIEM DO EKSPLOATACJI / RU - ПЕРЕД НАЧАЛОМ ИСПОЛЬЗОВАНИЯ / HR - PRIJE PRVE UPOTREBE  
/ GR - ΠΡΙΝ ΑΠΟ ΤΗΝ ΠΡΩΤΗ ΧΡΗΣΗ

1

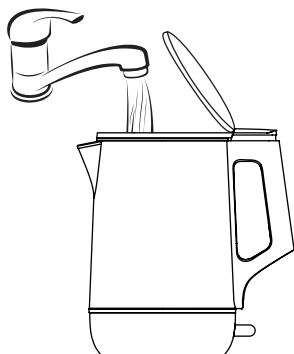

2

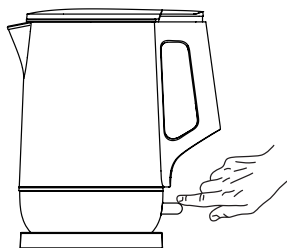

3

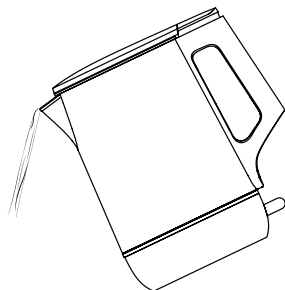

1

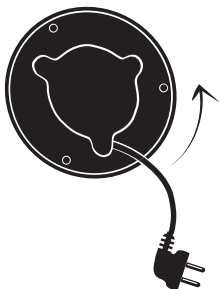

2

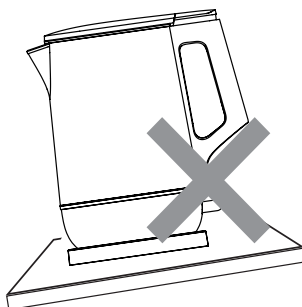
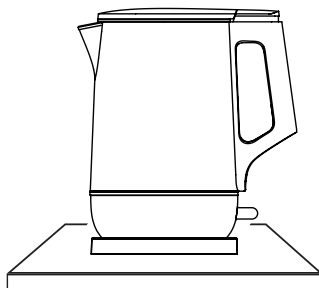

3



4

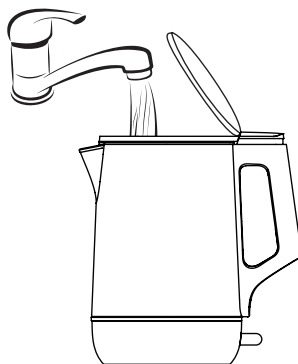

MAX 1.7L

MIN 0.3L

5

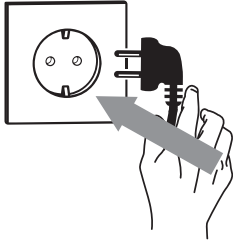

6

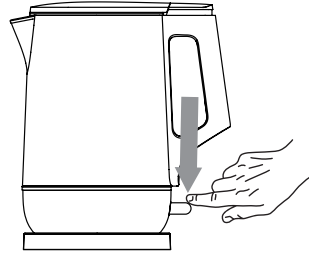

7

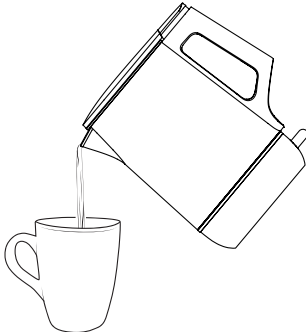

8

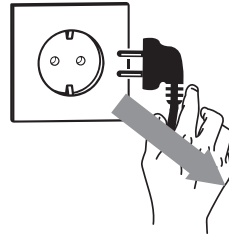

EN - PREMATURE KETTLE SHUT OFF / CZ - PŘEDČASNÉ VYPNUTÍ KONVICE / SK - PREDČASNÉ VYPNUTIE KANVICE / HU - A VÍZFORRALÓ KORÁBBI KIKAPCSOLÁSA / PL - WCZEŚNIEJSZE WYŁĄCZENIE CZAJNIKA / RU - ПРЕЖДЕВРЕМЕННОЕ ВЫКЛЮЧЕНИЕ ЧАЙНИКА / HR - PRIJEVREMENO ISKLJUČIVANJE KUHALA / GR - ΠΡΟΩΡΗ ΑΠΕΝΕΡΓΟΠΟΙΗΣΗ ΒΡΑΣΤΗΡΑ

1

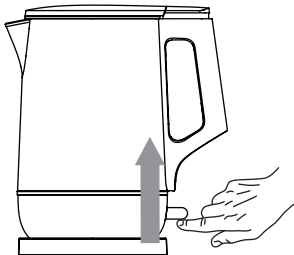

## Important safety instructions

### **READ CAREFULLY AND STORE FOR FUTURE USE.**

- This appliance may be used by children 8 years of age and older and by persons with physical, sensory or mental impairments or by inexperienced persons, if they are properly supervised or have been informed about how to use the product in a safe manner and understand the potential dangers.
- Children must not play with the appliance.
- Cleaning and maintenance performed by the user must not be performed by children unless they are older than 8 years of age and under supervision.
- Keep the appliance and its power cord out of reach of children younger than 8 years of age.
- In the event that the power cord is damaged, have it repaired at a professional service centre to prevent causing a dangerous situation. It is forbidden to use the appliance if it has a damaged power cord.
- This appliance is intended for home use. Likewise, this appliance is intended for personal non-commercial use in locations such as:
  - kitchens in stores, offices and other workplaces;
  - in agriculture;
  - guests of hotels, motels and other accommodation locations;
  - in bed and breakfast establishments.

- Do not wash the kettle or its base stand under running water and do not submerge it or its base stand in water or another liquid.
- If the kettle is overfilled, then hot water may splash out.



**WARNING:**

Do not open the lid while the water is boiling.



**ATTENTION:**

Position the lid so that the steam is directed away from the handle.

- Only use the kettle with the supplied base stand. Do not use the base stand with other types of appliances.



**ATTENTION:**

Make sure that the appliance is turned off before removing it from the base stand.



**ATTENTION:**

Make sure that the appliance is turned off before removing it from the base stand.



**WARNING:**

Do not spill anything on the power plug.

- Rinse out the inner surface of the kettle with clean water. Follow the cleaning instructions in chapter "Cleaning and maintenance".



**WARNING:**

Incorrect use may result in a risk of possible injury.

- The surface of the heating element retains residual heat after use. Do not touch the hot surface.

- Before connecting the kettle to a power socket check that the nominal voltage matches the electrical voltage in the socket.
- Connect the kettle only to a properly grounded socket.
- Do not place the kettle on window sills, kitchen sink drainboards or unstable surfaces. Always place it on a stable, even and dry surface.
- Do not place the kettle on an electric or gas stove or in its vicinity, do not place it in the vicinity of an open fire or an appliance that is a source of heat.
- Never use the kettle in the near vicinity of a bath, shower or swimming pool.
- Use the kettle exclusively for boiling drinking water. Do not use it to heat other liquids or foodstuffs.
- Do not fill the kettle when it is located on the base stand. Take the kettle off the base stand before filling it. When filling it, make sure that the water level covers at least the minimum mark and does not go past the maximum mark.
- Check that the lid is securely closed before starting the kettle.
- Do not turn on the kettle when it is empty. Incorrect use may negatively affect its lifetime. For the event that it is accidentally started without water, the kettle is equipped with a safety mechanism that protects it against damage.
- Use the handle for lifting and carrying.
- Be especially careful when pouring water out of the kettle to avoid scalding by the boiling water or steam.
- Do not pour icy cold water into the hot kettle.
- Always disconnect the kettle from the power socket when not using it, when leaving it without supervision, before moving or cleaning it.
- Disconnect the kettle from the power socket by gently pulling the plug of the power cord, and not the power cord itself. Otherwise, this could damage the power cord or the socket.
- To avoid the danger of injury by electrical shock, do not repair the kettle yourself or make any adjustments to it. Have all repairs or adjustments performed at an authorised service centre. By tampering with the appliance, you risk voiding your legal rights arising from unsatisfactory performance or quality warranty.

### Prevention of Household Injuries

Hot or boiling liquids pose a significant risk to children, and even minor burns can be serious. Observe basic household injury prevention rules and exercise increased caution when children are near hot or boiling liquids. If necessary, explain to children the risks associated with hot or boiling liquids. In the event of burns or scalds, immediately rinse the affected area under a stream of cold water and seek medical assistance if required.

### EXPLANATION OF SYMBOLS PLACED ON THE PRODUCT OR IN THE ACCOMPANYING DOCUMENTATION



This symbol on products or original documents means that used electric or electronic products must not be added to ordinary municipal waste.



This product meets all the basic requirements of EU directives related to it.

# Double Wall u-shape Electric Kettle

## User's manual

- Thank you for purchasing a SENCOR brand product and we hope that you will be happy with it.
- Prior to using this appliance, please read the user's manual thoroughly, even in cases, when one has already familiarised themselves with previous use of similar types of appliances. Only use the appliance in the manner described in this user's manual. Keep this user's manual in a safe place where it can be easily retrieved for future use.
- We recommend saving the original cardboard box, packaging material, purchase receipt and responsibility statement of the vendor or warranty card for at least the duration of the legal liability for unsatisfactory performance or quality. In the event of transportation, we recommend that you pack the appliance in the original box from the manufacturer.

### Before Use

Before first use, remove all packaging and advertising labels / stickers from the appliance.

### Automatic Shut-off

The kettle will automatically switch off once the water reaches the boiling point.

The kettle automatically switches off when it is lifted from the base while boiling water.

## CLEANING AND MAINTENANCE

- Disconnect the power plug from the power socket and allow the appliance to cool down before cleaning it.
- For cleaning, do not use cleaning products with an abrasive effect, solvents, etc. that could damage the appliance. No part of this appliance is intended for washing in a dishwasher.



### Warning:

To prevent the risk of injury by electrical shock, do not submerge the appliance, power cord or power plug in water or any another liquid.

- Wipe the kettle and the base stand with a clean sponge and wipe it dry with a wiping cloth. Regularly clean the filter with a soft sponge.

### Removing limescale deposits

- Limescale deposits inside the kettle may negatively affect its lifetime, so it is important to regularly remove it based on how frequently the kettle is used. During standard use (3 to 5 times per day), we recommend limescale deposits be removed:
  - once per month in areas with hard and very hard water;
  - once every two to three months in areas with soft and medium hard water.
- Scale build-up increases the noise level of the kettle.
- To remove the scale, we recommend the Sencor SESXD 001 liquid agent. Follow the dosage and procedure instructions which you can find on the packaging of the descaling agent. Alternatively, you can also use 8% white vinegar (in proportion 1 : 1 with water) or citric acid (approximately 30 g per 1 l of water) which you boil and let sit. After you pour it out, boil clean water in the kettle before next use (4 to 5 times).

### Storage

- When not using the appliance for an extended period of time, disconnect the power plug from the power socket, allow the appliance to cool down and clean it according to the instructions in chapter "Cleaning and maintenance".
- Before storing it, check that the appliance and all its accessories are thoroughly clean and dry.

- Store the appliance in a dry, clean and well-ventilated location not exposed to extreme temperatures and out of children's reach.

## TECHNICAL SPECIFICATIONS

Rated voltage range.....	220–240 V~
Rated frequency.....	50–60 Hz
Rated power input.....	1800 W
Maximum capacity.....	1.7

We reserve the right to change text and technical specifications.

Due to the continuous development, the images in this user's manual may differ from the actual appliance. We reserve the right to such a change.

Off mode	
Power consumption in off mode	0 W
Time needed for the equipment to automatically reach off mode	0 min
Standby mode	
Power consumption in standby mode	–
Time needed for the equipment to automatically reach standby mode	–
Networked standby mode (Wi-Fi)	
Power consumption in networked standby	–
Time needed for the equipment to automatically reach networked standby mode	–

## INSTRUCTIONS AND INFORMATION REGARDING THE DISPOSAL OF USED PACKAGING MATERIALS

Dispose of used packaging material at a site designated for waste in your municipality.

## DISPOSAL OF USED ELECTRICAL AND ELECTRONIC EQUIPMENT

For proper disposal, renewal and recycling, hand these appliances over to determined collection points. Alternatively, in some European Union states or other European countries you may return your products to the local retailer when buying an equivalent new product. Correct disposal of this product helps save valuable natural resources and prevents potential negative effects on the environment and human health, which could result from improper waste disposal. Ask your local authorities or collection facility for more details. In accordance with national regulations penalties may be imposed for the incorrect disposal of this type of waste.

### For business entities in European Union states

If you want to dispose of electrical or electronic equipment, ask your retailer or supplier for the necessary information.

### Disposal in other countries outside the European Union.

This symbol is valid in the European Union. If you wish to dispose of this product, request the necessary information about the correct disposal method from the local council or from your retailer.

