



KONICA MINOLTA

bizhub 226 USER'S GUIDE

✎ Scan





Table of contents

1 Introduction

1.1	Welcome	1-3
1.1.1	User's guides	1-3
1.1.2	User's Guide	1-3
1.2	Conventions used in this manual	1-4
1.2.1	Symbols used in this manual	1-4
	To use this machine safely.....	1-4
	Procedural instruction.....	1-4
	Key symbols.....	1-5
1.2.2	Original and paper indications	1-5
	Original and paper sizes	1-5
	Original and paper indications	1-5

2 Scan

2.1	How to scan.....	2-3
2.2	Network scan	2-5
2.2.1	Scan to E-mail.....	2-5
2.2.2	Scan to Server (FTP).....	2-6
2.2.3	Scan to Server (SMB).....	2-7
2.3	Environment necessary for scanning.....	2-8
2.3.1	Scan driver	2-8
2.3.2	Network scan	2-8
2.3.3	Scan to USB	2-8

3 Scan from the Computer

3.1	Install scan driver (TWAIN/WIA).....	3-3
3.2	TWAIN driver.....	3-4
3.2.1	How to scan originals	3-4
3.2.2	Setting driver.....	3-4
	[Document Size].....	3-5
	[Scan Mode].....	3-5
	[Resolution]	3-5
	[Scan Type]	3-5
	[Image Size].....	3-5
	[LAN/USB].....	3-6
	[About].....	3-6
	[Scan]	3-6
	[Close]	3-6
	[Clear].....	3-6
	[Prescan]	3-6
	[Unit].....	3-6
	[Help]	3-6
	[Scanning Mode].....	3-7
	[Duplex Scanning]	3-7
3.3	WIA driver	3-8
3.3.1	How to scan originals	3-8
3.3.2	Setting driver.....	3-8
3.4	Uninstall scan driver (TWAIN/WIA).....	3-10

4 Register of Destinations

4.1	Registering destinations	4-3
4.1.1	Registration of One-touch Dial	4-4
4.1.2	Registration of speed dial	4-5
	Registering FTP/SMB Server address	4-7
4.1.3	Registration of group dial.....	4-7
4.2	Correcting and deleting registered data	4-8
4.2.1	Correcting and deleting One-touch Dial	4-8
4.2.2	Correcting and deleting speed dial.....	4-8
4.2.3	Correcting and deleting group dial	4-9

5 How to Use Scan to E-mail

5.1	Basic transmission method	5-3
5.1.1	When using the ADF	5-3
	Loading double-sided originals	5-4
5.1.2	When setting an original on the Original Glass	5-5
5.2	Changing transmission setting	5-7
5.2.1	Setting subject	5-7
5.2.2	CC address setting	5-7
	Checking and Correcting CC addresses	5-8
5.2.3	Setting file format.....	5-8
5.2.4	Setting compression coding method.....	5-9
5.3	Changing the setting for the scanned image quality	5-10
5.3.1	Setting for resolution.....	5-10
5.3.2	Color setting.....	5-10
5.3.3	Setting for original type.....	5-10
5.4	Changing the setting for scanned original density	5-11
5.4.1	Test/Photo, Text mode setting	5-11
5.4.2	Setting of Photo mode.....	5-12
5.5	Sets the initial value for the scan setting items	5-13
5.5.1	Setting of image quality (resolution).....	5-13
5.5.2	Setting file format.....	5-13
5.5.3	Setting compression coding method.....	5-13
5.5.4	Color setting.....	5-14
5.6	Memory shortage occurrence while scanning the original	5-15
5.7	One-touch Dial can be used to select the destination	5-16
5.8	Speed dial can be used to select the destination	5-17
5.9	Selecting the destination from the group dial	5-18
5.10	Select the destination from the phone book	5-19
5.10.1	How to search Phone Book	5-19
5.10.2	How to search LDAP server.....	5-20
5.11	Checking communication results	5-21

6 How to Use Scan to Server

6.1	Basic transmission method	6-3
6.1.1	When using the ADF	6-4
	Loading double-sided originals	6-5
6.1.2	When setting an original on the Original Glass	6-5
6.2	Change transmission setting	6-7
6.2.1	Setting file format.....	6-7
6.2.2	Setting compression coding method.....	6-7
6.3	Memory shortage occurrence while scanning the original	6-8



7 How to Use Scan to USB

7.1	How to scan originals	7-3
7.1.1	When using the ADF	7-3
	Loading double-sided originals	7-4
7.1.2	When setting an original on the Original Glass	7-5
7.2	Changing the scan settings	7-7
7.2.1	Setting file format.....	7-7
7.2.2	Setting compression coding method.....	7-7

8 PageScope Web Connection

8.1	Overview	8-3
8.1.1	Operating environments.....	8-3
8.2	How to use PageScope Web Connection	8-4
8.2.1	How to access	8-4
8.2.2	How to view the screen	8-4
8.2.3	User mode and administrator mode	8-5
8.2.4	How to operate	8-5
8.3	User mode	8-6
8.3.1	[System] - [Summary].....	8-6
8.3.2	[System] - [Details]	8-6
8.3.3	[System] - [Maintenance] - [Counter]	8-7
8.3.4	[System] - [Maintenance] - [Power Save Setting]	8-8
8.3.5	[System] - [Online Assistance]	8-8
8.3.6	[Print Job] - [Print Job Management]	8-9
8.3.7	[Print Job] - [File Download].....	8-9
8.3.8	[Print] - [Settings] - [Paper Handling]	8-10
8.3.9	[Print] - [Settings] - [Paper Layout].....	8-10
8.3.10	[Print] - [Settings] - [Printer Setting]	8-11
8.3.11	[Print] - [Test Print]	8-12
8.3.12	[Print] - [Font Information]	8-12
8.3.13	[Address] - [One-Touch Dial Setting]	8-13
8.3.14	[Address] - [Speed Dial Setting].....	8-13
8.3.15	[Address] - [Group Dial Setting]	8-14
8.3.16	[Network] - [Summary]	8-14

9 Troubleshooting

9.1	Error of TWAIN driver	9-3
9.2	Error of network scan	9-4
9.2.1	If you suspect a failure then do the following	9-5
9.3	Error of Scan to USB	9-6

10 Appendix

10.1	Main product specifications	10-3
10.1.1	Network scan	10-3
10.1.2	Scan to USB	10-3

11 Index

11.1	Index by item	11-3
11.2	Index by button	11-4





Introduction

1 Introduction

1.1 Welcome

Thank you for purchasing this machine.

This User's Guide describes the functions, operating instructions, precautions for correct operation, and simple troubleshooting guidelines of this machine. In order to obtain maximum performance from this product and use it effectively, please read this User's Guide as necessary.

1.1.1 User's guides

User's guide DVD manuals	Overview
[Quick Guide]	This manual describes operating procedures and the most frequently used functions to enable you to begin using this machine immediately. This manual describes details on trademarks and copyrights. <ul style="list-style-type: none"> • Trademarks and copyrights
[User's Guide Copy]	This manual describes details on copy mode operations and the settings of this machine. <ul style="list-style-type: none"> • Specifications of originals and copy paper • Copy function • Maintaining this machine • Troubleshooting
[User's Guide Fax]	This manual describes fax mode operations and settings. <ul style="list-style-type: none"> • G3 fax function • Internet Fax • PC-FAX
[User's Guide Print]	This manual describes details on printer functions. <ul style="list-style-type: none"> • Printer function • Setting the printer driver
[User's Guide Scan]	This manual describes details on scan functions. <ul style="list-style-type: none"> • Scan Function • Setting the TWAIN/WIA scan driver • Network scan (E-mail TX, FTP TX, and SMB TX) • Scan to USB
[User's Guide Network Administrator]	This manual describes details on setting methods for each function using the network connection. <ul style="list-style-type: none"> • Network settings • Settings using PageScope Web Connection

1.1.2 User's Guide

This User's Guide is intended for users ranging from those using this machine for the first time to administrators.

It describes basic operations, functions that enable more convenient operations, maintenance procedures, simple troubleshooting operations, and various setting methods of this machine.

Note that basic technical knowledge about the product is required to enable users to perform maintenance work or troubleshooting operations. Limit your maintenance and troubleshooting operations to the areas explained in this manual.

Should you experience any problems, please contact our service representative.

1.2 Conventions used in this manual

1.2.1 Symbols used in this manual

Symbols are used in this manual to express various types of information.

The following describes each symbol related to correct and safe usage of this machine.

To use this machine safely

WARNING

- This symbol indicates that a failure to heed the instructions may lead to death or serious injury.

CAUTION

- This symbol indicates that negligence of the instructions may lead to mishandling that may cause injury or property damage.

NOTICE

This symbol indicates a risk that may result in damage to this machine or documents. Follow the instructions to avoid property damage.

Tips

- This symbol indicates supplemental information of a topic as well as options required to use a function.



Reference

This symbol indicates reference functions related to a topic.

Procedural instruction

- ✓ This check mark indicates an option that is required in order to use conditions or functions that are prerequisite for a procedure.

1 This format number "1" represents the first step.

2 This format number represents the order of serial steps.

- ➔ This symbol indicates a supplementary explanation of a procedural instruction.

The operation procedures are described using illustrations.

- ➔ This symbol indicates transition of the **Display** to access a desired menu item.

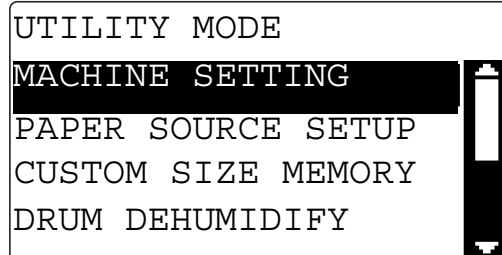

This symbol indicates a desired page.



Reference

This symbol indicates a reference.

View the reference as required.

Key symbols

[]

Display items, key names on the computer screen, or a name of a user guide by these brackets.

Bold text

Key names, part names, product names and option names on the **Control Panel** are indicated in bold text.

1.2.2 Original and paper indications

Original and paper sizes

The following explains the indication for originals and paper described in this manual.

When indicating the original or paper size, the Y side represents the width and the X side the length.

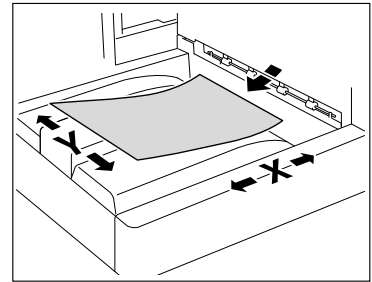

Original and paper indications

▣ indicates the paper size with the length (X) being longer than the width (Y).

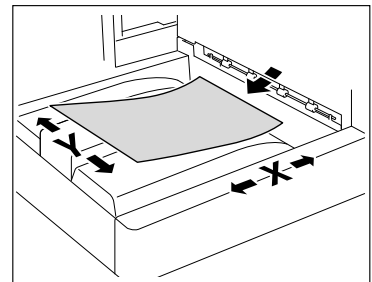

▣ indicates the paper size with the length (X) being shorter than the width (Y).

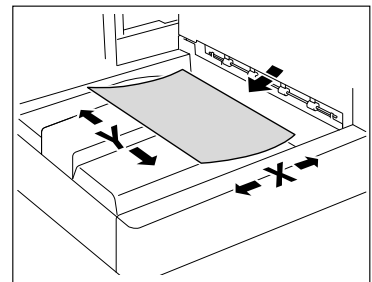

2 Scan

2 Scan

2.1 How to scan

There are several methods that can be used to load originals onto a computer as a file by using the scanning function of this machine. Different methods can be used depending on the case.

The method of scanning differs according to the operation and connection method.

The following types of operation are available:

- Install a driver onto a computer and operate the machine from the computer by using the read application.
- Operate the machine by selecting a menu from the **Control Panel**.

The following connecting methods are available:

- Connect this machine directly to the computer using a USB cable.
- Access via Internet, Intranet or other TCP/IP network (if **Network Card NC-504** or **Image Controller IC-209** and **Extended Operation Panel MK-749** are installed).
- Save scanned data onto a USB memory inserted in this machine.

This machine can work with the following types of scan functions:

	Description	How to operate		Connection method		
		Computer	Control Panel	Direct connection via USB cable	Connection via networks	Data receiving and forwarding using a USB memory
TWAIN driver (p. 3-3)	Install a TWAIN driver onto the computer and fetch scan data from TWAIN-based application. Resolutions, file size and other detailed settings are enabled.	○	-	○	○	-
WIA driver (p. 3-8)	Install a WIA driver on the computer and obtain scan data using an application that supports a Windows standard WIA driver. Data can be easily loaded; it is barely necessary to make settings.	○	-	○	○ ^{*1}	-
Scan to E-mail ^{*2} (p. 2-5, p. 5-3)	Transmit the scanned data via E-mail	-	○	-	○	-
Scan to Server (FTP) ^{*2} (p. 2-6, p. 6-3)	Upload scanned data onto the specified FTP server on the Internet.	-	○	-	○	-
Scan to Server (SMB) ^{*2} (p. 2-7, p. 6-3)	Save the scanned data into a shared folder (SMB server) on the Intranet.	-	○	-	○	-

	Description	How to operate		Connection method		
		Computer	Control Panel	Direct connection via USB cable	Connection via networks	Data receiving and forwarding using a USB memory
Scan to USB (p. 2-8, p. 7-3)	Save the scanned data onto the USB memory inserted in this machine.	-	○	-	-	○

*1: When a Web service is enabled.

*2: If **Network Card NC-504** or **Image Controller IC-209** and **Extended Operation Panel MK-749** are installed

2.2 Network scan

To transmit or save the scanned data via network by operating **Control Panel**, a corresponding network environment is required. Choose a method that is compatible with the user's environment.

Tips

- Network scan requires the machine to have either optional **Network Card NC-504** or **Image Controller IC-209** and **Extended Operation Panel MK-749** installed.
- To use network scan function, TCP/IP network environment is required.

For details on the network-related setting method of this machine, refer to the [User's Guide Network Administrator].

2.2.1 Scan to E-mail

Tips

- A network environment with a mail server is required.

Attach the scanned data to a mail as a PDF, TIFF or JPEG file. Transmit the file to the other computer via computer on the network or Internet.

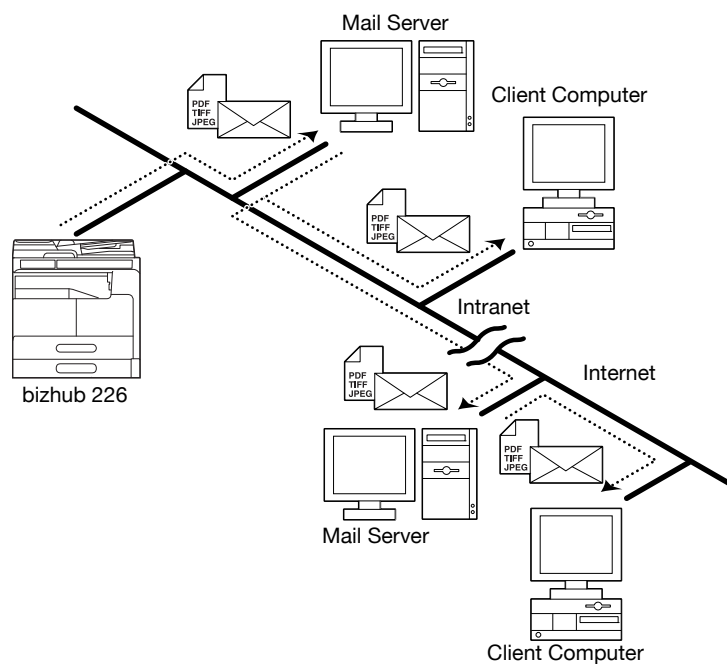

2.2.2 Scan to Server (FTP)

Upload the scanned data as a TIFF, JPEG or PDF file to a directory specified by the FTP server.

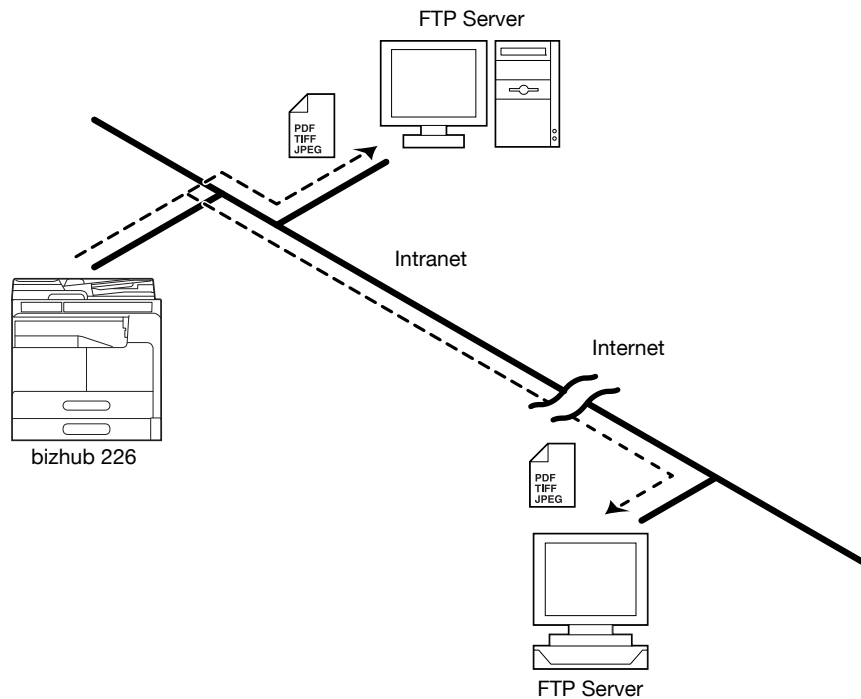

Tips

- A network environment with a FTP server is required.
- Access to FTP server on Internet is enabled via proxy server.

This machine can be set to inform specified parties (maximum 10) of the storage location of uploaded data within the FTP via mail.

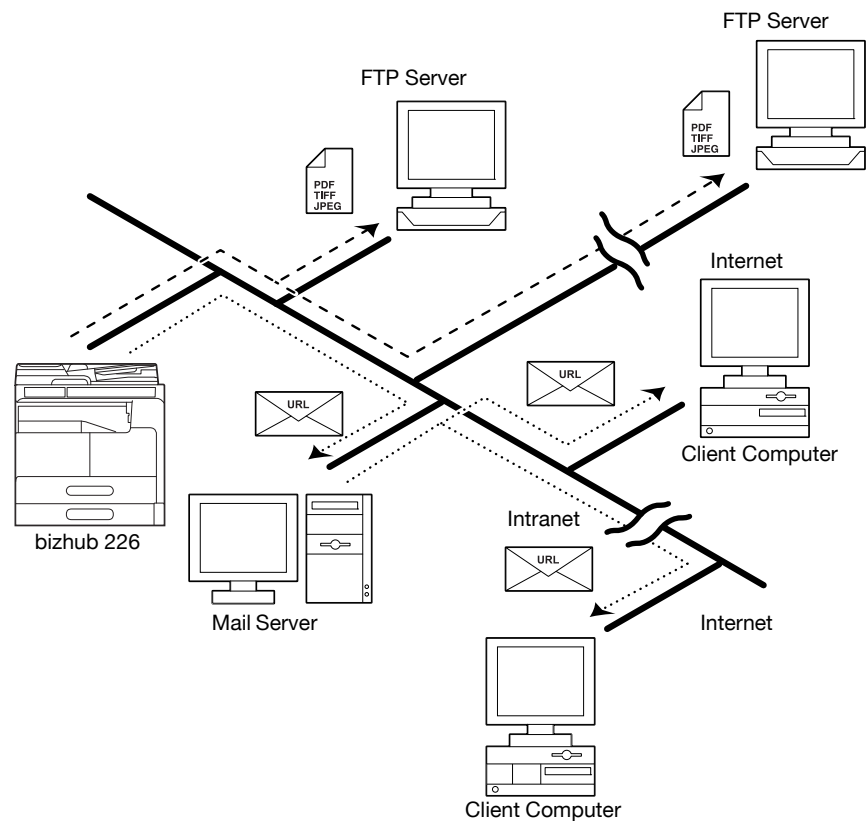

2.2.3 Scan to Server (SMB)

This machine stores the scanned data as PDF, TIFF or JPEG file in the shared folder of SMB server and shared PC.

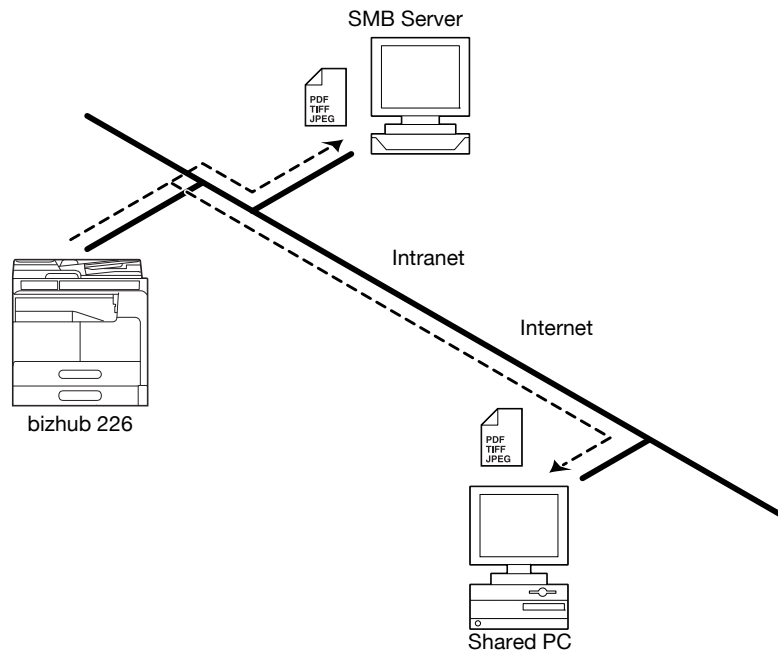

Tips

- A shared folder accessible from this machine will be required.

This machine can be set to inform specified destinations (up to 10) via E-mail of the storage location (the SMB server or the shared folder of the shared computer) of uploaded data.

2.3 Environment necessary for scanning

2.3.1 Scan driver

	TWAIN	WIA
OS	Windows Vista/7/8/8.1/Server 2008/Server 2008 R2/Server 2012/Server 2012 R2	
Application software	TWAIN-compliant image processing software (Adobe Photoshop, Adobe Acrobat Professional, etc.)	WIA-compliant image processing software
Connecting terminal	USB 2.0 (Hi-Speed USB) compatible Ethernet 10Base-T / 100Base-TX (when installed with optional Network Card NC-504 or Image Controller IC-209)	USB 2.0 (Hi-Speed USB) compatible

2.3.2 Network scan

Tips

- Network scan requires the machine to have either optional **Network Card NC-504** or **Image Controller IC-209** and **Extended Operation Panel MK-749** installed.

	Scan to E-mail	Scan to Server (FTP)	Scan to Server (SMB)
Necessary environment for image data transfer	Mail server (SMTP server)	<ul style="list-style-type: none"> • FTP Server • Mail server (SMTP server) for using mail notification 	<ul style="list-style-type: none"> • SMB server or shared folder of shared PC • Mail server (SMTP server) for using mail notification
Environment necessary for fetching image data	<ul style="list-style-type: none"> • Mail client PC • Mail server (POP3 server) 	FTP client PC	Client PC accessible to shared folder

2.3.3 Scan to USB

Item	Description
File system	FAT16 / FAT32
Maximum capacity of USB memory	4 GB



Scan from the Computer

3 Scan from the Computer

By using the **ADF** or **Original Glass**, this machine can carry out scanning.

3.1 Install scan driver (TWAIN/WIA)

TWAIN driver/WIA driver are installed together when the printer driver is installed.

For details on installation procedures, refer to the [User's Guide Print].

3.2 TWAIN driver

This section describes TWAIN driver functions.

3.2.1 How to scan originals

Scanning is enabled using a TWAIN-compliant application. The operation method differs depending on the application to be used. This section describes the operation by using Adobe Photoshop.

Tips

- The **ADF** is an option.

- 1 Set an original to be scanned on the **ADF** or **Original Glass**.
- 2 Start an application software (Adobe Photoshop, etc.) on the computer.
- 3 Click [File].
- 4 Select [Import], then select [KONICA MINOLTA <model_name> TWAIN].
- 5 Make the necessary setting.
 - For details, refer to page 3-4.
- 6 Click [Scan].
 - If [Pull Scan] method is selected, this machine starts scanning.
 - If [Push Scan] method is selected, press **Start** on the **Control Panel** to start scanning.

3.2.2 Setting driver

Item	Settings
[Document Size]	[A3 SEF], [B4 SEF], [A4 SEF], [B5 SEF], [A5 SEF], [FLS 8 1/4 × 13 in], [FLS 8 1/2 × 13 in], [FLS 220 × 330 mm], [FLS 8 1/8 × 13 1/4 in], [FLS 8 × 13 in], [A4 LEF], [B5 LEF], [A5 LEF], [11 × 17 SEF], [Legal SEF], [Letter SEF], [Invoice SEF], [Letter LEF], [Invoice LEF], [8K SEF], [16K SEF], [16K LEF] For details, refer to page 3-5.
[Scan Mode]	[Full Color], [Grey], [B/W(Photo)], [Text] For details, refer to page 3-5.
[Resolution]	[150 dpi × 150 dpi], [300 dpi × 300 dpi], [600 dpi × 600 dpi]. For details, refer to page 3-5.
[Scan Type]	[Push Scan],[Pull Scan] (initial setting) For details, refer to page 3-5.
[Duplex Scanning]	The screen indicates that the optional ADF is installed. [OFF], [ON] For details, refer to page 3-7.
[Scanning mode]	Select scan setting for [Auto] or [Manual].
[Image size]	Image capacity is indicated. For details, refer to page 3-5.
[Brightness/Contrast, Sharp, Curves, Level, Color Balance, Hue/Saturation, Default]	While in [Scanning Mode], this is indicated if [Manual] is selected. For details, refer to page 3-7.
[LAN/USB]	You can verify or change USB and network connection setting. For details, refer to page 3-6.
[About]	Displays printer driver version information. For details, refer to page 3-6.
[Scan]	Scans the image. For details, refer to page 3-6.

Item	Settings
[Close]	Stops scanning. For details, refer to page 3-6.
[Clear]	Deletes pre-scan images. For details, refer to page 3-6.
[Prescan]	Pre-scans and displays the image. For details, refer to page 3-6.
[Help]	Displays Help file. For details, refer to page 3-6.
[Unit]	[in], [cm], [pixel] For details, refer to page 3-6.

[Document Size]

Specify the size of original to be scanned.

Tips

- If the target image for scanning is larger than the size specified by the Manuscript, the portion exceeding the specified size will be deleted.
- If the target image for scanning is smaller than the size specified by the Manuscript, the image is scanned to the specified size.

[Scan Mode]

Select the image quality of the original.

- [Full Color]: Appropriate for color copying.
- [Grey]: Appropriate for monochromatic copying.
- [B/W (Photo)]: Appropriate for photography.
- [Text]: Appropriate for documentation in general.

[Resolution]

Specify the print resolution.

If [Scan Mode] is set to [Full Color] or [Gray], [600 dpi e 600 dpi] is not displayed.

- [150 dpi × 150 dpi]: Resolution good for standard character size. The resolution supports efficient scanning.
- [300 dpi × 300 dpi]: Resolution good for small character size. An initial setting is made for this resolution.
- [600 dpi × 600 dpi]: High resolutions appropriate for landscapes and images of people.

[Scan Type]

A scanning method can be selected.

- [Pull Scan]: Click the driver [Scan] button, then this machine starts scanning.
- [Push Scan]: Press Start on the Control Panel, then this machine starts scanning.

[Image Size]

Displays the size of the scanned image.

[LAN/USB]

Connection method can be selected.

- If network is selected, an IP address can be set or changed by following procedures shown below:

- 1 Select [Network].
- 2 Enter an IP address to be newly registered or changed.
 - Click [Search], then an IP addresses of devices connected to the network will be displayed. Select the pertinent IP address, then click [OK].
- 3 When an IP address is set up, click [OK].

[About]

The version information screen appears.

[Scan]

Scan the original.

[Close]

Stops scanning.

[Clear]

Deletes images scanned using pre-scanning.

[Prescan]

Pre-scans the original and displays it in the pre-scan window.

[Unit]

Select a display unit from the drop-down list.

[Help]

The Help screen appears.

[Scanning Mode]

[Brightness/Contrast]

- Pressing the  button displays a screen that enables brightness and color contrast to be adjusted.
- The initial setting is [0%].
- Brightness can be set between -100% (dark) and +100% (bright). Contrast can be set between -100% to +100%.

[Sharp]

- Pressing the  button displays a screen that enables color sharpness to be adjusted.
- The initial setting is [0].
- Brightness can be set between -2 and +3.

[Curves]

- Pressing the  button displays a screen that enables the curve of colors to be adjusted.
- The initial setting is [0].
- Curves can be set between -100 and +100.

[Levels]

- Pressing the  button displays a screen that enables color levels to be adjusted.
- The initial settings are; minimum entry value: [0], maximum entry value: [255], gamma value: [1.00], minimum output value: [0], and maximum output value: [255].
- The following setting ranges apply; for minimum entry value: between 0 and 247, for maximum entry value: between 8 and 255, for gamma value: between 0.10 and 9.99, for minimum output value: between 0 and 247, for maximum output value: between 8 and 255. (The smallest difference between a maximum and a minimum value cannot be lower than 8).

[Color Balance]

- Pressing the  button displays a screen that enables color balance to be adjusted.
- The initial setting is [0].
- Color balance can be set between -100 and +100.

[Hue/Saturation]

- Pressing the  button displays a screen that enables hue, saturation, and brightness to be adjusted.
- The initial setting is [0].
- Hue can be set between -180 and +180, while saturation and brightness can be set between -100 and +100.

[Default]

- Press [Default] to return the setting to the default value.

[Duplex Scanning]

Duplex Scanning is indicated if optional **ADF** is installed. This function selects ON-OFF for duplex (double face printing).

3.3 WIA driver

This section describes the functions of the WIA driver.

3.3.1 How to scan originals

Scanning is enabled using a WIA-compliant application. The operation method differs depending on the application to be used. This section describes the operation by using Adobe Photoshop 6.0.

- 1 Set an original to be scanned on the **ADF** or **Original Glass**.
- 2 Start an application software (Adobe Photoshop, etc.) on the computer.
- 3 Click [File].
- 4 Select [Import], then click [WIA-KONICA MINOLTA <model_name> Scanner].
 - If a message dialog appears, check the contents and click [OK].
- 5 Make the necessary setting for scanning.
 - For details, refer to page 3-8.
- 6 Click [Scan].
 - Press this key to start scanning.
 - To stop scanning, press the [Cancel] or Esc key.

3.3.2 Setting driver

Item	Settings
[Scanner]	Displays the scanner name of this machine. To switch other scanner, click [Change].
[Profile]	Select a profile to fit the original you want to load onto this machine. <ul style="list-style-type: none"> • [Photo]: Select this option to scan an original that consists primarily of photos. • [Documents]: Select this option to scan an original that consists primarily of text. • [Last used settings]: Select this option to scan an original using the previous settings. • [Add profile]: Select this option to create a new profile other than the options above and add it as an option. Selecting [Add profile] displays the [Add New Profile] window.
[Source]	Select the position to set the original. <ul style="list-style-type: none"> • [Flatbed]: Select this option to load the original on the Original Glass. By selecting [Flatbed], you can use [Preview], which is a scan function. • [Feeder (Scan one side)]: Select this option to load the 1-sided original on the ADF. • [Feeder (Scan both sides)]: Select this option to load the 2-sided original on the ADF.
[Paper size]	When [Feeder (Scan one side)] or [Feeder (Scan both sides)] is selected in Source, specify the size of the original to be scanned.
[Color format]	Select a color mode for scanning originals from [Color], [Grayscale] or [Black and white]. The original is scanned in the selected color mode regardless of the original color.

Item	Settings
[File type]	Select a file type to save a file. <ul style="list-style-type: none"> • [BMP]: Used to save an image file adopted by the "Paint" software supplied with Windows. This type does not support a function that compresses data to be saved, so the file size is larger than JPEG or PNG. • [JPG]: Used to save files frequently used with digital cameras, which is available for saving photos. JPEG does not support the saving of multiple pages into one file. • [PNG]: Used to save an image file with no quality degradation when compressing a file. Note that some files cannot be displayed in old Web browsers. • [TIF]: This is one kind of versatile image formats. This type is available for a multi-page file that provides multiple pages in one file. • [XPS]: A file type that is supported in Windows Vista or later.
[Resolution]	Adjusts the print resolution. Print resolution can be selected to be either [150], [300], or [600]. The initial setting is [300].
[Brightness]	Adjusting brightness. Brightness can be set between -100% (dark) and +100% (bright). The initial setting is [0%].
[Contrast]	Adjusting contrast. Contrast can be set between -100 and +100. The initial setting is [0].
[Preview]	Displays a scanning preview. Adjust the scan range by moving the frame of the Preview screen.
[Scan]	Press this key to start scanning.
[Cancel]	Closes the settings screen.

3.4 Uninstall scan driver (TWAIN/WIA)

- 1 Start the uninstall program.
 - In Windows Vista/7/Server 2008/Server2008 R2, open the start menu, then click [All Program](or [Programs]) - [KONICA MINOLTA XXXX Scanner] - [UnInstScan].
 - In Windows 8/Server 2012, right-click the Start window, select [All apps] - [KONICA MINOLTA XXXX Scanner] - [UnInstScan].
 - In Windows 8.1/Server 2012 R2, click [⌵] in the Start window, [KONICA MINOLTA XXXX Scanner] - [UnInstScan].
 - Depending on the settings on the computer, the UAC (User Account Control) dialog box may appear. Check the details, and continue.
- 2 Click [Next].

A confirmation dialog box appears.
- 3 Click [Yes].

The completion screen appears when the driver has been deleted.
- 4 Click [Finish].

4

Register of Destinations

4 Register of Destinations

This chapter describes the process to register addresses of the destination when using the Scan to E-mail / Scan to Server function.

Tips

- To use Scan to E-mail / Scan to Server function, **Network Card NC-504** or **Image Controller IC-209** and **Extended Operation Panel MK-749** must be installed.

4.1 Registering destinations

The destinations for Scan to E-mail can be registered either from [Control Panel] or [PageScope Web Connection]. The destinations for Scan to FTP/SMB can be registered only from [PageScope Web Connection]. This section describes the registration process from [Control Panel].



Reference

For details on registration by using **PageScope Web Connection**, refer to [User's Guide Network Administrator].

Functions	Destinations with registered E-mail addresses	Description
Scan to E-mail	One-touch Dial	Press One-touch Dial Key to specify the destination with ease. In an environment where LDAP server is in use, addresses may be retrieved from the LDAP server for registration.
	Speed dial number	The destinations can be specified using three digit speed dialing number. In an environment where LDAP server is in use, addresses may be retrieved from the LDAP server for registration.
	Group dial	Simultaneous transmission to multiple destinations can be made simultaneously using a single dial key.
Scan to Server	Speed dial number (FTP/SMB Server address registration)	Data can be uploaded to FTP/SMB server.

4.1.1 Registration of One-touch Dial

- 1 Press the **Utility** key.
- 2 Press **▲▼**, select [DIAL REGISTRATION], then press **OK**.
- 3 Press **▲▼**, select [ONE-TOUCH DIAL], then press **OK**.
- 4 Press the key to register to a One-touch Dial number.
The registered key number is indicated and the registration setting screen appears.
→ Number from 01 to 32 can be registered.
- 5 Select either [MANUAL SETTING] or [LDAP SEARCH], then press **OK**.
→ If [MANUAL SETTING] is selected, go to Step 6.
→ If [LDAP SEARCH] is selected, go to Step 8.
- 6 Enter the destination name, then press **OK**.

ONE-TOUCH DIAL 01

NAME

: X X X [A ...]

- 7 Enter an E-mail address, then press **OK**.

ONE-TOUCH DIAL 01

DESTINATION

: Z [A ...]

OTHER SETTING= ▼

One-touch Dial is registered.

- When transmitting data over Internet fax, [OTHER SETTING=▼] appears when an E-mail address is entered. Transmission size, resolution, etc. can be set.
For details on the Internet fax, refer to [User's Guide Fax].

- 8 Select [NAME] or [E-MAIL], then press **OK**.
- 9 Enter some of the characters included in the registered name or address to carry out the search, then press **OK**.
→ You can enter up to 10 characters for a search.
→ If an error is made during entry, press **Clear/Stop**, erase the mistyped character, then re-enter.
→ If [BEGIN] is set, the machine searches for the registered name or address starting with the entered character.
→ If [CONTAIN] is set, the machine searches for the registered name or address containing the entered character or address.
→ If [END] is set, the machine searches for the registered name or address ending with the character or address entered.

The corresponding name or address of the destination will be displayed.

- 10 Press **▲▼**, select the registered name or address from the search results, then press **OK**.
 - Press **▶**, then the machine indicates the name and E-mail address. Check them, and press **OK**. If a selection error is made, press **Back**. Displays the previous screen.
 - If the searched E-mail address contains more than 64 characters, the screen returns to the address registration screen.
- 11 Check the destination name, then press **OK**.
- 12 Check the E-mail address, then press **OK**.
 - One-touch Dial is registered.
 - When transmitting using the Internet fax, press **▼** and the transmission size and resolution can be set up.
 - For details on the Internet fax, refer to [User's Guide Fax].

4.1.2 Registration of speed dial

- 1 Press the **Utility** key.
- 2 Press **▲▼**, select [DIAL REGISTRATION], then press **OK**.
- 3 Press **▲▼**, select [SPEED DIAL], then press **OK**.
- 4 Enter the speed dial number for registration, then press **OK**.

SPEED DIAL
SPEED DIAL: 001

- PRESS OK KEY -

The registration setting screen appears.

→ Speed dial number can be registered from 001 to 250.

- 5 Select either [MANUAL SETTING] or [LDAP SEARCH], then press **OK**.
 - If [MANUAL SETTING] is selected, go to Step 6.
 - If [LDAP SEARCH] is selected, go to Step 9.
- 6 Enter the destination name, then press **OK**.

SPEED DIAL 001
NAME
: X X X [A ...]

- 7 Enter an E-mail address, then press **OK**.

ONE-TOUCH DIAL 01

DESTINATION

: Z [A...]

OTHER SETTING= ▼

Speed dial number is registered.

- When transmitting data over Internet fax, [OTHER SETTING=▼] appears when an E-mail address is entered. Transmission size, resolution, etc. can be set. For details on the Internet fax, refer to [User's Guide Fax].

- 8 Select [NAME] or [E-MAIL], then press **OK**.

- 9 Enter some of the characters included in the registered name or address to carry out the search, then press **OK**.

- You can enter up to 10 characters for a search.
- If an error is made during entry, press **Clear/Stop**, erase the mistyped character, then re-enter.
- If [BEGIN] is set, the machine searches for the registered name or address starting with the entered character.
- If [CONTAIN] is set, the machine searches for the registered name or address containing the entered character or address.
- If [END] is set, the machine searches for the registered name or address ending with the character or address entered.

The corresponding name or address of the destination will be displayed.

- 10 Press ▲▼, select the registered name or address from the search results, then press **OK**.

- Press ►, then the machine indicates the name and E-mail address. Check them, and press **OK**. If a selection error is made, press **Back**. Displays the previous screen.
- If the searched E-mail address contains more than 64 characters, the screen returns to the address registration screen.

- 11 Check the destination name, then press **OK**.

- 12 Check the E-mail address, then press **OK**.

Speed dial number is registered.

- When transmitting using the Internet fax, press ▼ and the transmission size and resolution can be set up. For details on the Internet fax, refer to [User's Guide Fax].

Registering FTP/SMB Server address

Registers FTP/SMB server address for transmitting the scanned data to FTP/SMB server to a speed dial number between [251] and [300] from [PageScope Web Connection].



Reference

To register an FTP/SMB server address to the speed dial number, the user will have to access **PageScope WebConnection** in Administrator mode.

For details on accessing **PageScope Web Connection** in Administrator mode, refer to **PageScope Web Connection** in [User's Guide Network Administrator].

For registration of the FTP/SMB server address to the speed dial number, refer to **PageScope Web Connection** - [Address] tab - [Speed Dial Setting] in [User's Guide Network Administrator].

4.1.3 Registration of group dial

Tips

- To register a group dial number, the E-mail address of the destination has to be registered in advance in One-touch Dial or with the speed dial number.

- Press the **Utility** key.
- Press **▲▼**, select [DIAL REGISTRATION], then press **OK**.
- Press **▲▼**, select [GROUP DIAL], then press **OK**.
- Press **One-touch Dial Key** to register to group dial.
The registration setting screen appears.
- Enter the group name, then press **OK**.

```
GROUP DIAL 001
NAME
: X X X      [ A ... ]
```

- Specify the destination using **One-touch Dial Key** or the speed dial number, then press **OK**.
- Press **▲▼**, select [ADD], then press **OK**.
- Return to Step 6 and specify the next destination to be registered.
Repeat Steps 6 and 7 until all the destinations are specified.
- Press **▲▼** to select [RETURN], then press **OK**.
The screen returns to the address registration screen.

4.2 Correcting and deleting registered data

4.2.1 Correcting and deleting One-touch Dial

- 1 Press the **Utility** key.
- 2 Press **▲▼**, select [DIAL REGISTRATION], then press **OK**.
- 3 Press **▲▼**, select [ONE-TOUCH DIAL], then press **OK**.
- 4 Press **One-touch Dial Key** to correct or delete.
 - If the group dial or program is registered to the **One-touch Dial Key**, the screen returns to the address registration screen.
- 5 Press **▲▼**, then select [EDIT] or [DELETE].
 - To correct, select [EDIT], then press **OK**. Go to the next step.
 - To delete, select [DELETE], then press **OK**. The screen returns to the address registration screen.
- 6 Change the name or address of the destination as needed.

For the modification method of other settings, refer to page 4-4.

When all settings are complete, the screen returns to the address registration screen.

 - If the corrected One-touch Dial number is registered to the group dial, press **▲▼**, press [YES] or [NO], then press **OK**.

4.2.2 Correcting and deleting speed dial

- 1 Press the **Utility** key.
- 2 Press **▲▼**, select [DIAL REGISTRATION], then press **OK**.
- 3 Press **▲▼**, select [SPEED DIAL], then press **OK**.
- 4 Enter the registered speed dial number to correct or delete, then press **OK**.
- 5 Press **▲▼**, then select [EDIT] or [DELETE].
 - To correct, select [EDIT], then press **OK**. Go to the next step.
 - To delete, select [DELETE], then press **OK**. The screen returns to the address registration screen.
- 6 Change the name or address of the destination as needed.

For the modification method of other settings, refer to page 4-5.

When all settings are complete, the screen returns to the address registration screen.

4.2.3 Correcting and deleting group dial

- 1 Press the **Utility** key.
- 2 Press **▲▼**, select [DIAL REGISTRATION], then press **OK**.
- 3 Press **▲▼**, select [GROUP DIAL], then press **OK**.
- 4 Press **One-touch Dial Key** to correct or delete.
 - If the One-touch Dial or program is registered to the **One-touch Dial Key**, the screen returns to the address registration screen.
- 5 Press **▲▼**, then select [EDIT] or [DELETE].
 - To correct, select [EDIT], then press **OK**. Go to the next step.
 - To delete, select [DELETE], then press **OK**. The screen returns to the address registration screen.
- 6 Correct the group name, then press **OK**.
- 7 To add the destination, select [ADD], then press **OK**.

Specify the destination in the screen displayed by **One-touch Dial Key** or speed dial number.
- 8 To check or delete destination, select [CHECK/EDIT], then press **OK**.
 - Check the registered destination in the displayed screen.
 - Pressing **OK** enables to check the destination in detail.
 - To delete the destination, press **Clear/Stop** in the Check/Edit screen, then press [YES]. Press **OK**.
 - To return to the screen for adding, checking or deleting destinations, press **Back**.
- 9 When all the changes are made, press **▲▼**, select [RETURN], then press **OK**.

The screen returns to the address registration screen.

A large, bold, black number '5' is centered within a gray square. The square is positioned to the left of the main title text.

How to Use Scan to E-mail

5 How to Use Scan to E-mail

This chapter describes how to transmit scanned data.

Tips

- To use the Scan to E-mail function, **Network Card NC-504** or **Image Controller IC-209** and **Extended Operation Panel MK-749** must be installed.

5.1 Basic transmission method

Tips

- With Scan to E-mail, documents are transmitted via mail server. No direct communication with the destination is made. Also, transmission will be handled as completed when communication with the server ends normally. To carry out this operation, an IP address, SMTP server address, E-mail address, etc. has to be set in advance.

5.1.1 When using the ADF

- 1 Press the **Scan** key.

The machine switches to the scan mode.

- 2 Load the original onto the **ADF**.

→ The maximum number of originals that can be placed at one time into the ADF is 70. Do not set originals above the ▼ mark.

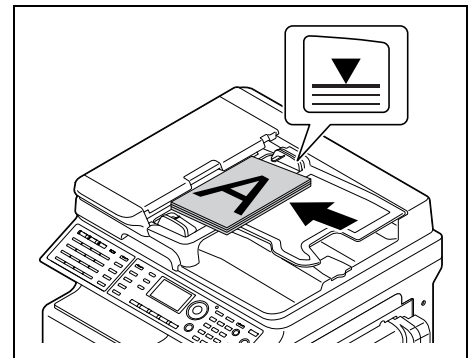

- For details on how to set the original, refer to [User's Guide Copy].
 → For details on how to set a double-sided original, refer to page 5-4.

- 3 Enter the E-mail address of the destination.

```
150dpiBW TIFF 100%
TEXT/PHOTO  [A] AUTO [B]
TO  XXX@XXX.XXX  [A...]
-----
OTHER SETTING= [▼]
```

- A maximum of 64 characters can be entered.
 → Pressing ▼ enables the subject, CC address, file format, and compression coding method to be changed. For details, refer to page 5-7.
 → One-touch Dial can be used to select the destination. For details, refer to page 5-16.
 → Speed dial can be used for selecting the destination. For details, refer to page 5-17.

→ Telephone directory can be used to select the destination. For details, refer to page 5-19.

4 Press the **Start** key.

Scanning/sending starts.

Tips

- To stop scanning, press **Clear/Stop**.
- If you are unable to send data, the TX Result Report is output.



Reference

To cancel transmission of scanned data while standing by for transmission, press **Function** and select [CANCEL RESERV.]. For details, refer to [User's Guide Fax].

Loading double-sided originals

1 Load the original.

→ For details on how to set the original, refer to [User's Guide Fax].

2 Press Simplex/Duplex.

A screen for specifying **Simplex/Duplex** appears.

3 Select [1-SIDE] or [2-SIDE] using ▲▼, then press **OK**.

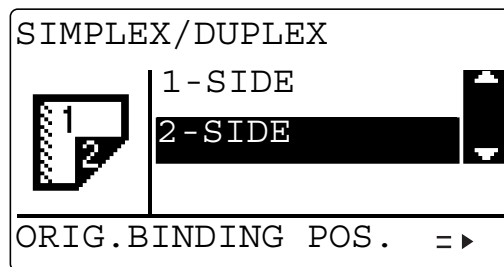

→ When you select [2-SIDE] and press ►, you can specify the binding direction of the original. Select [LEFT] or [TOP], then press **OK**.

Tips

- The binding direction can be set only when you select [PDF] for the file format.

5.1.2 When setting an original on the Original Glass

- 1 Press the **Scan** key.
The machine switches to the scan mode.
- 2 Set the original onto the **Original Glass**.

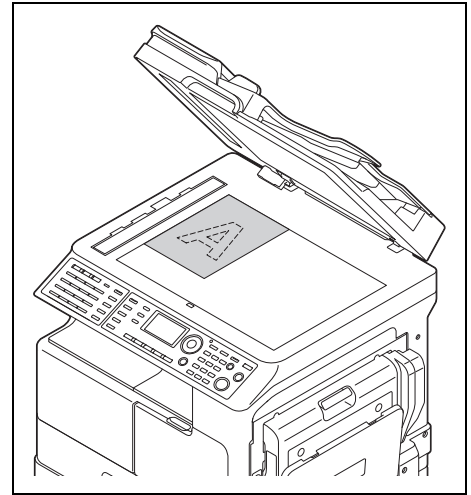

→ For details on how to set the original, refer to [User's Guide Copy].

- 3 Enter the E-mail address of the destination.

```
150dpiBW TIFF 100%
TEXT/PHOTO  [A] AUTO [B]
TO  XXX@XXX.XXX  [A...]
-----
OTHER SETTING= [C]
```

- A maximum of 64 characters can be entered.
 - Pressing ▼ enables the subject, CC address, file format, and compression coding method to be changed. For details, refer to page 5-7.
 - The destination may be specified by the following method.
 - One-touch Dial can be used to select the destination. For details, refer to page 5-16.
 - Speed dial can be used for selecting the destination. For details, refer to page 5-17.
 - Telephone directory can be used to select the destination. For details, refer to page 5-19.
- 4 Press the **Start** key.
 - 5 Press ▲▼, then select [AUTO DETECTION] or [MANUAL].
 - If [AUTO DETECTION] is selected, press **OK** and go to Step 8.
 - If [MANUAL] is selected, scanning size can be selected. Press ► and go to Step 6.
 - 6 Press ▲▼ to select desired scanning size, then press **OK**.
 - By pressing [INCH] or [METRIC], the measuring scanning size can be changed.
 - 7 Press **OK**.

- 8 Check the content of setting, then press **OK**.
Scanning starts and [NEXT PAGE?] is displayed.

```
150dpiBW TIFF 90%  
TEXT/PHOTO  [AUTO]  
NEXT PAGE? (AUTO)  1  
-----  
SCAN=OK (SEND=START)
```

→ When scanning multiple sheets of the original, set the next original on the **Original Glass**, then press **OK**. Repeat the above procedure for all sheets of the original.

- 9 When all the originals have been scanned, press the **Start** key.
Sending starts.

Tips

- To stop scanning, press **Clear/Stop**.
- If you are unable to send data, the TX Result Report is output.



Reference

To cancel transmission of scanned data while standing by for transmission, press **Function** and select [CANCEL RESERV.]. For details, refer to [User's Guide Fax].

5.2 Changing transmission setting

The subject, CC address, file format, and compression coding method can be changed.

5.2.1 Setting subject

- 1 Press the **Scan** key.
→ The machine switches to the scan mode.
- 2 Set the original and enter the destination address.
[OTHER SETTING=▼] is displayed.
- 3 Press ▼.
The other setting screen appears.
- 4 Press ▲▼ to select [SUBJECT], then press **OK**.
- 5 Enter the subject (title) of a mail to be transmitted, then press **OK**.

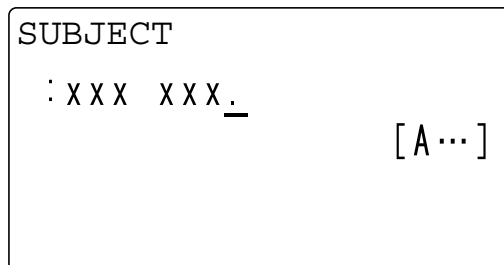

The screen returns to the other setting screen.

Tips

- A maximum of 20 characters can be entered.

5.2.2 CC address setting

- 1 Press the **Scan** key.
→ The machine switches to the scan mode.
- 2 Set the original and enter the destination address.
→ [OTHER SETTING=▼] is displayed.
- 3 Press ▼.
The other setting screen appears.
- 4 From the other setting screen, press ▲▼ to select [CC ADDRESS], then press **OK**.
- 5 Enter the E-mail address of the destination for CC'ing the message to, then press **OK**.
→ To add other E-mail addresses, select [ADD], then press **OK**. Repeat the above procedure until all concerned destinations are added.
→ To check or correct the CC address entered, select [CHECK/EDIT], then press **OK**.

Tips

- A maximum of 254 addresses can be entered in the CC box.

Checking and Correcting CC addresses

- 1 In the [ADD] and [CHECK/EDIT] screen of CC Address, press ▲▼, select [CHECK/EDIT], then press **OK**.
A list of the entered CC addresses is displayed.
- 2 Press ▲▼, then select the address to be checked or corrected.
 - Press **Clear/Stop** to display the Delete screen. Press ▲▼ to select [YES], then press **OK**. The selected address is deleted and the CC address list screen is displayed. To continue deleting addresses, repeat this procedure.
 - Press **OK** to display only the selected addresses. Press **Clear/Stop** and delete the address character by character. After deleting all characters, press **OK**, then the Delete screen appears. Press ▲▼ to select [YES], then press **OK**. The selected address is deleted and the CC address list screen is displayed. To continue deleting addresses, repeat this procedure.
- 3 In the CC address list screen, press **RETURN**.
The [ADD] and [CHECK/EDIT] screen of CC address appears.
- 4 Press ▲▼ to select [RETURN], then press **OK**.
The screen returns to the other setting screen.

5.2.3 Setting file format

- 1 Press the **Scan** key.
The machine switches to the scan mode.
- 2 Set the original and enter the destination address.
[OTHER SETTING=▼] is displayed.
- 3 Press ▼.
The other setting screen appears.
- 4 Press ▲▼ to select [IMAGE FORMAT], then press **OK**.
- 5 Press ▲▼, then select file format.
 - The file format can be selected from [TIFF], [PDF], or [JPEG].
 - If [Color Setting] for [Quality] is set to [BW], [JPEG] is not displayed.
- 6 Press **OK**.
The screen returns to the other setting screen.

5.2.4 Setting compression coding method

- 1 Press the **Scan** key.
The machine switches to the scan mode.
- 2 Set the original and enter the destination address.
[OTHER SETTING=▼] is displayed.
- 3 Press ▼.
The other setting screen appears.
- 4 Press ▲▼ to select [BW CODING METHOD], then press **OK**.
- 5 Press ▲▼, then select compression coding method.
→ Compression coding method can be selected from [MH], [MR], or [MMR].
- 6 Press **OK**.
The screen returns to the other setting screen.

5.3 Changing the setting for the scanned image quality

The setting for scanned image quality can be changed.

5.3.1 Setting for resolution

- 1 Press the **Scan** key.
The machine switches to the scan mode.
- 2 Press the **Quality** key.
- 3 Press **▲▼** to select [RESOLUTION], then press **OK**.
- 4 Press **▲▼**, then select resolution for scanning.
 - Resolution can be selected for [150 × 150 dpi], [300 × 300 dpi], [600 × 600 dpi].
 - If [Color Setting] for [Quality] is either set to [Color] or [Gray], [600 × 600 dpi] is not displayed.
 - The factory default is [300 × 300 dpi].
- 5 Press **OK**.
The screen returns to the Scan screen.

5.3.2 Color setting

- 1 Press the **Scan** key.
The machine switches to the scan mode.
- 2 Press the **Quality** key.
- 3 Press **▲▼** to select [COLOR SETTING], then press **OK**.
- 4 Press **▲▼** to select desired color setting.
 - The color setting can be selected from [BW], [GRAY], or [COLOR].
 - If [BW] is selected when [Image Format] is set to [JPEG], [PDF] is automatically selected.
 - The factory default is [BW].
- 5 Press **OK**.
The screen returns to the Scan screen.

5.3.3 Setting for original type

- 1 Press the **Scan** key.
The machine switches to the scan mode.
- 2 Press the **Quality** key.
- 3 Press **▲▼** to select [ORIGINAL], then press **OK**.
- 4 Press **▲▼**, then select the image quality of the original.
 - The image quality of the original can be selected from [TEXT/PHOTO], [TEXT], or [PHOTO].
 - The factory default is [TEXT/PHOTO].
- 5 Press **OK**.
The screen returns to the Scan screen.

5.4 Changing the setting for scanned original density

The setting for the scan quality of the original can be changed in the screen used to set density.

5.4.1 Test/Photo, Text mode setting

This indicates the setting procedure in the image quality setting when [TEXT/PHOTO] or [TEXT] is set.

- 1 Press the **Scan** key.
The machine switches to the scan mode.
- 2 Press the **Density** key.
A screen used to set density appears.
- 3 Specify desired density.
 - If [Color Setting] for [Quality] is set to [BW], press ▲▼, and select either [AUTO] or [MANUAL].
 - If the image quality of original type is either [TEXT/PHOTO] or [TEXT], select [AUTO] or [MANUAL]. For Auto setting, select [AUTO], then press **OK**. For the manual setting, select [MANUAL], press ◀ or ▶, then press **OK**.



- If [Color Setting] for [Quality] is set to [Gray] or [Color], [AUTO] is not displayed. The gray setting can only be made using [MANUAL].
- When setting manually, pressing ◀ reduces density. Pressing ▶ increases density.
- When **OK** is pressed after density is adjusted, the scan screen will display a density corresponding to the adjusted density.

Tips

- The factory default is [AUTO].

5.4.2 Setting of Photo mode

This describes the image quality setting when [PHOTO] is set.

- 1 Press the **Scan** key.
The machine switches to the scan mode.
- 2 Press the **Density** key.
- 3 Press ◀ or ▶ to adjust density.



→ Pressing ◀ reduces density. Pressing ▶ increases density.

- 4 Press **OK** to display the scan screen that shows the density corresponding to the adjusted density.
→ If density is adjusted to the left of the midpoint, the scan screen is displayed darker on the left-hand side. If density is adjusted to the right of the midpoint, the scan screen is displayed darker on the right-hand side.

Tips

- The factory default is set at the midpoint.

5.5 Sets the initial value for the scan setting items

Initial value for image quality (resolution), file format, compression coding method, and color setting can be changed for making transmission using Scan to E-mail, and Scan to Server.

5.5.1 Setting of image quality (resolution)

- 1 Press the **Utility** key.
- 2 Press **▲▼** to select [SCAN SETTING], then press **OK**.
- 3 Press **▲▼** to select [RESOLUTION], then press **OK**.
- 4 Press **▲▼** to select resolution.
→ Resolution can be selected for [150 × 150 dpi], [300 × 300 dpi], [600 × 600 dpi].
- 5 Press **OK**.
The screen returns to the Scan Settings screen.

5.5.2 Setting file format

- 1 Press the **Utility** key.
- 2 Press **▲▼** to select [SCAN SETTING], then press **OK**.
- 3 Press **▲▼** to select [IMAGE FORMAT], then press **OK**.
- 4 Press **▲▼**, then select file format.
→ The file format can be selected from [TIFF], [PDF], or [JPEG].
- 5 Press **OK**.
The screen returns to the Scan Settings screen.

5.5.3 Setting compression coding method

This item is displayed only when [BW] is selected for the color setting.

- 1 Press the **Utility** key.
- 2 Press **▲▼** to select [SCAN SETTING], then press **OK**.
- 3 Press **▲▼** to select [BW CODING METHOD], then press **OK**.
- 4 Press **▲▼**, then select compression coding method.
→ Compression coding method can be selected from [MH], [MR], or [MMR].
- 5 Press **OK**.
The screen returns to the Scan Settings screen.

5.5.4 Color setting

- 1 Press the **Utility** key.
- 2 Press **▲▼** to select [SCAN SETTING], then press **OK**.
- 3 Press **▲▼** to select [COLOR SETTING], then press **OK**.
- 4 Press **▲▼** to select desired color setting.
→ The color setting can be selected from [BW], [GRAY], or [COLOR].
- 5 Press **OK**.
The screen returns to the Scan Settings screen.

5.6 Memory shortage occurrence while scanning the original

In the **ADF**, a warning message is output while the original is being scanned when memory shortage becomes imminent. Select whether to continue transmission or cancel it.

When memory shortage is imminent, a warning message is output followed by Memory Shortage/Transmission Cancel screen.

- Press **▲▼** to select [YES] or [NO], then press **OK**.
 - Select [YES] then press **OK**. The screen returns to the Scan Setting screen and transmission will be canceled.
 - Select [NO] and press **OK**. Then a message reading [*WAIT MEMORY SPACE*] appears and the transmission for scanned pages starts. When transmission is completed, scanning of the remaining pages automatically starts.
 - If a memory shortage occurs while the original pages are being scanned on the **Original Glass**, select [NO] when the warning message shows, then press **OK**. Then, transmission of the scanned pages starts. The screen returns to the Scan screen when transmission is completed.
 - When the automatic reset time has elapsed in the Memory Shortage/Transmission Cancel screen, [MEMORY FULL] is displayed and the transmission result reports will be printed. Press any key to return to the Scan screen.

5.7 One-touch Dial can be used to select the destination

- 1 Press the **Scan** key.
The machine switches to the scan mode.
- 2 Press **One-touch Dial Key** (from **01** to **32**) that has been registered to the E-mail address of the destination.

Tips

- Destinations have to be registered for One-touch dialing in advance.
- For details on One-touch Dial registration, refer to page 4-3.

5.8 Speed dial can be used to select the destination

- 1 Press the **Scan** key.
The machine switches to the scan mode.
- 2 Press **Speed Dial** and enter a 3-digit speed dial number (the number signifying which E-mail address is registered).

```
150dpiBW TIFF 100%  
TEXT/PHOTO  [AUTO]  
SPEED DIAL:250  
  
-PRESS OK KEY-
```

- 3 Press **OK**.
The destination is set.

Tips

- Destinations have to be registered for speed dialing.
- For details on how to register speed dial numbers, refer to page 4-3.

5.9 Selecting the destination from the group dial

- 1 Press the **Scan** key.
The machine switches to the scan mode.
- 2 Press **One-touch Dial Key** (from **01** to **32**) that has been registered to the group.

Tips

- Destinations have to be registered for group dialing in advance.
- For details on group dialing registration, refer to page 4-3.
- If a single fax number is registered with the destinations for the group dialing, that group dial cannot be used for mail transmission (Scan to E-mail). In this case, a message reading [NOT E-MAIL ADDRESS] appears in the **Display**.

5.10 Select the destination from the phone book

Phone book displays the contents registered to the One-touch Dial and the Speed dial. In addition, in the environment where LDAP server can be used, the registered contents can be displayed by searching LDAP server. Using this function, destinations can be searched from the phone book and specified for transmission.

- 1 Press the **Scan** key.
The machine switches to the scan mode.
- 2 Press **AddressBook**.
- 3 Press **▲▼** to select either [LIST], [SEARCH] or [LDAP SEARCH], then press **OK**.
 - Specifying [LIST] displays the registered contents of One-touch Dial and Speed dial. Press **▲▼**, then select the destination.
 - Selecting [SEARCH] displays a screen used to enter the retrieval character string. Enter part (or all) of the registered name of the destination for search. For steps on searching Phone book, refer to page 5-19.
 - Selecting [LDAP SEARCH] enables the user to search for the address of the destination registered on the LDAP server. For steps on how to carry out LDAP SEARCH, refer to page 5-20.
- 4 Press the **Start** key.
Sending starts.

5.10.1 How to search Phone Book

- 1 Press the **Scan** key.
 - The machine switches to the scan mode.
- 2 Press **AddressBook**.
- 3 Press **▲▼** to select [SEARCH], then press **OK**.
- 4 Enter a certain number of leading characters of the registered name of the destination.
 - Enter part of the registered name to One-touch Dial or Speed dial.
 - You can enter up to 10 characters.
- 5 Press **OK**.
Displays the search results.
 - If the machine fails to find the corresponding registered name after a search is carried out, the screen returns to the screen shown in Step 4.
- 6 Select the destination, then press **OK**.
The destination name appears on the Scan screen.
 - When the destination name is entered, [OTHER SETTING=▼] is displayed. Pressing ▼, the subject (title), CC address, file format, etc. can be changed. For details, refer to page 5-7.
- 7 Press the **Start** key.
Sending starts.

5.10.2 How to search LDAP server

- 1 Press the **Scan** key.
The machine switches to the scan mode.
- 2 Press **AddressBook**.
- 3 Press **▲▼** to select [LDAP SEARCH], then press **OK**.
- 4 Select [NAME] or [E-MAIL], then press **OK**.
- 5 Enter some of the characters contained in the registered name or address.
→ You can enter up to 10 characters for a search.
- 6 Press **OK**.
The corresponding name or address of the destination will be displayed.
→ Press **▲▼** to select a name, then press **▶**. Then the name and E-mail address are displayed.
→ Press **▲▼** to select E-mail address , then press **OK**. The name and E-mail address appear.
- 7 Press **OK**.
The E-mail address of the destination will be set on the Scan screen.
→ Pressing **▼** enables to change the subject, cc address, file format, etc. For details, refer to page 5-7.
→ If the searched E-mail address contains more than 64 characters, the screen returns to the address registration screen.
- 8 Press the **Start** key.
Sending starts.

5.11 Checking communication results

Communication results of scan can be checked.

- 1 Press the **Scan** key.
The machine switches to the scan mode.
- 2 Press the **Confirm** key.
- 3 Press **▲▼**, then select [TX/RX RESULT].
- 4 Press **OK**.

All the transmission results are displayed.

→ The transmission results are displayed from the latest result. Press **▼**, then past communication results are displayed sequentially.

TX/RX RESULT

60 (JUL.25 14:25) TX 

XXX-XXX - OK

REPORT=START 

If **Network Card NC-504** or **Image Controller IC-209** is installed on this machine, NTP server can be set. Contents of displayed communication results differ depending on whether or not the NTP server has been specified.

When the NTP server is set:

Data transmitted by Scan to E-mail or Scan to Server will have a transmission number and date displayed.

When the NTP server is not set:

Data transmitted by Scan to E-mail or Scan to Server will only have a transmission number displayed, not a date.

- 5 Press **OK**.
The screen returns to the Scan screen.



How to Use Scan to Server

6 How to Use Scan to Server

This chapter describes how to transmit scanned data to the server.

Tips

- To use Scan to Server function, **Network Card NC-504** or **Image Controller IC-209** and **Extended Operation Panel MK-749** must be installed.

6.1 Basic transmission method

This section describes the basic transmission method.

Tips

- To run Scan to Server (FTP/SMB), the FTP/SMB server address has to be registered as a speed dial number in advance.
- When uploading scanned data onto the server, the user can set whether an E-mail is sent to notify of successful data unloading. This machine can register ten E-mail addresses.
To inform the other party via E-mail, SMTP server has to be registered in advance.
- To register a server or to set up E-mail notification, access to **PageScope WebConnection** has to be set up in the administrator mode. These settings cannot be made through the Control Panel.



Reference

For details on accessing **PageScope Web Connection** in Administrator mode, refer to **PageScope Web Connection** in [User's Guide Network Administrator].

For details on registration of the FTP/SMB server address to the speed dial number and setting of information by E-mail, refer to **PageScope Web Connection** - [Address] tab - [Speed Dial Setting] in [User's Guide Network Administrator].

For details on setting SMTP server, refer to **PageScope Web Connection** - [Network] tab - [SMTP & POP3 Configuration] in [User's Guide Network Administrator].

6.1.1 When using the ADF

- 1 Press the **Scan** key.
The machine switches to the scan mode.
- 2 Load the original onto the **ADF**.
→ The maximum number of originals that can be placed at one time into the ADF is 70. Do not set originals above the ▼ mark.

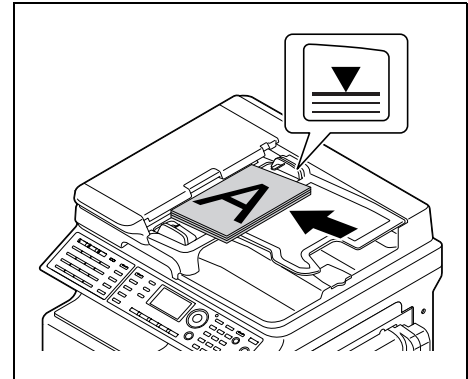

- For details on the setting direction of the original, refer to [User's Guide Copy].
- For details on how to set a double-sided original, refer to page 6-5.

- 3 Press **Speed Dial** and enter a 3-digit speed dial number (the number registered to the target FTP or SMB server address desired for uploading) using the **Keypad**.

```
150dpiBW TIFF 100%
TEXT/PHOTO  AUTO
SPEED DIAL:251

-PRESS OK KEY-
```

- 4 Press **OK**.
The destination is displayed.
→ By pressing ▼, the file format and transmission settings for the compression coding method can be changed. For details, refer to page 6-7.
→ Specify the speed dial number to be within the range of [251] to [300].
→ An error message will appear if nothing is registered for a specified speed dial number. Enter the speed dial number again.

- 5 Press the **Start** key.
Scanning/sending starts.

Tips

- To stop scanning, press **Clear/Stop**.
- If you are unable to send data, the TX Result Report is output.



Reference

To cancel transmission of scanned data while standing by for transmission, press **Function** and select [CANCEL RESERV.]. For details, refer to [User's Guide Fax].

Loading double-sided originals

- 1 Load the original.
→ For details on how to set the original, refer to [User's Guide Fax].
- 2 Press Simplex/Duplex.
A screen for specifying **Simplex/Duplex** appears.
- 3 Select [1-SIDE] or [2-SIDE] using ▲▼, then press **OK**.

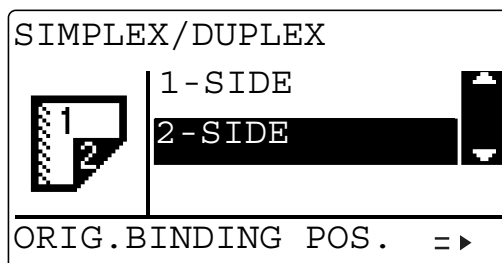

- When you select [2-SIDE] and press ►, you can specify the binding direction of the original. Select [LEFT] or [TOP], then press **OK**.

Tips

- The binding direction can be set only when you select [PDF] for the file format.

6.1.2 When setting an original on the Original Glass

- 1 Press the **Scan** key.
The machine switches to the scan mode.
- 2 Set the original onto the **Original Glass**.

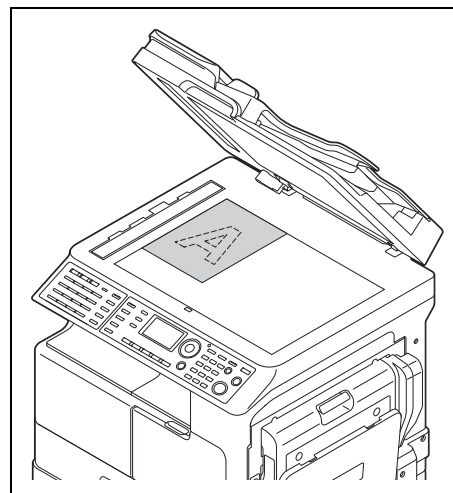

- For details on how to set the original, refer to [User's Guide Copy].

- 3 Press **Speed Dial** and enter a 3-digit speed dial number (the number registered to the target FTP or SMB server address desired for uploading) using the **Keypad**.

```
150dpiBW TIFF 100%
TEXT/PHOTO  [AUTO]
SPEED DIAL:251

-PRESS OK KEY-
```

- 4 Press **OK**.
The destination is displayed.
- By pressing **▼**, the file format and transmission settings for the compression coding method can be changed. For details, refer to page 6-7.
 - Specify the speed dial number to be within the range of [251] to [300].
 - An error message will appear if nothing is registered for a specified speed dial number. Enter the correct speed dial number.
- 5 Press the **Start** key.
- 6 Press **▲▼**, then select [AUTO DETECTION] or [MANUAL].
- If [AUTO DETECTION] is selected, press **OK** and go to Step 9.
 - If [MANUAL] is selected, scanning size can be selected. Press **▶** and go to Step 7.
- 7 Press **▲▼** to select desired scanning size, then press **OK**.
- By pressing [INCH] or [METRIC], the measuring scanning size can be changed.
- 8 Press **OK**.
- 9 Check the content of setting, then press **OK**.
Scanning starts and [NEXT PAGE?] is displayed.

```
150dpiBW TIFF 90%
TEXT/PHOTO  [AUTO]
NEXT PAGE? (AUTO) [1]

-----
SCAN=OK (SEND=START)
```

- When scanning multiple sheets of the original, set the next original on the **Original Glass**, then press **OK**. Repeat the above procedure for all sheets of the original.

- 10 When all the originals have been scanned, press the **Start** key.
Sending starts.

Tips

- To stop scanning, press **Clear/Stop**.
- If you are unable to send data, the TX Result Report is output.
- To change the scanning quality setting, refer to page 5-10.



Reference

To cancel transmission of scanned data while standing by for transmission, press **Function** and select [CANCEL RESERV.]. For details, refer to [User's Guide Fax].

6.2 Change transmission setting

You can change the file format and compression coding method.

6.2.1 Setting file format

- 1 Press the **Scan** key.
The machine switches to the scan mode.
- 2 Set the original and enter the destination address.
[OTHER SETTING= ▼] is displayed.
- 3 Press ▼.
The other setting screen appears.
- 4 Press ▲▼ to select [COLOR SETTING], then press **OK**.
- 5 Press ▲▼, then select file format.
 - The file format can be selected from [TIFF], [PDF], or [JPEG].
 - If [Color Setting] for [Quality] is set to [BW], [JPEG] is not displayed.
- 6 Press **OK**.
The screen returns to the other setting screen.

6.2.2 Setting compression coding method

- 1 Press the **Scan** key.
The machine switches to the scan mode.
- 2 Set the original and enter the destination address.
[OTHER SETTING= ▼] is displayed.
- 3 Press ▼.
The other setting screen appears.
- 4 Press ▲▼ to select [BW CODING METHOD], then press **OK**.
- 5 Press ▲▼, then select compression coding method.
 - Compression coding method can be selected from [MH], [MR], or [MMR].
- 6 Press **OK**.
The screen returns to the other setting screen.

6.3 Memory shortage occurrence while scanning the original

In the **ADF**, a warning message is output while the original is being scanned when memory shortage becomes imminent. Select whether to continue transmission or cancel it.

When memory shortage is imminent, a warning message is output followed by Memory Shortage/Transmission Cancel screen.

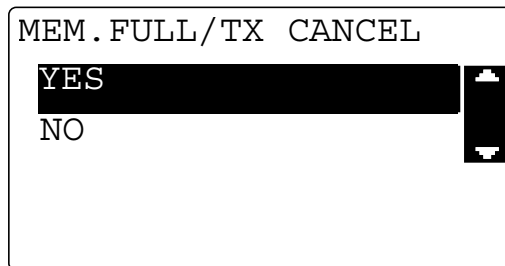

- Press ▲▼ to select [YES] or [NO], then press **OK**.
 - Select [YES] then press **OK**. Then the screen returns to the Scan screen.
 - Select [NO] and press **OK**. Then a message reading [*WAIT MEMORY SPACE*] appears and the transmission for scanned pages starts. When transmission is completed, scanning of the remaining pages automatically starts.
 - If a memory shortage occurs while the original pages are being scanned on the **Original Glass**, select [NO] when the warning message shows, then press **OK**. Then, transmission of the scanned pages starts. The screen returns to the Scan screen when transmission is completed.
 - When the automatic reset time has elapsed in the Memory Shortage/Transmission Cancel screen, [MEMORY FULL] is displayed and the transmission result reports will be printed. Press any key to return to the Scan screen.

7

How to Use Scan to USB

7 How to Use Scan to USB

This chapter describes how to store scanned data on the USB memory.

7.1 How to scan originals

7.1.1 When using the ADF

- 1 Place the originals to be stored in the USB memory on the **ADF**.
 - The maximum number of originals that can be placed at one time into the ADF is 70. Do not set originals above the ▼ mark.

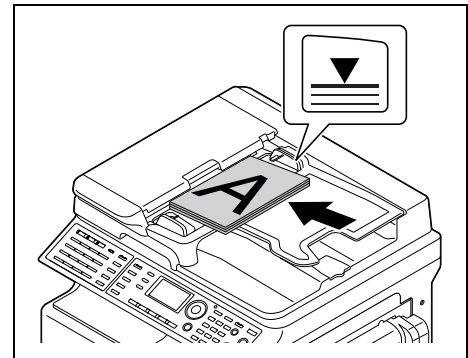

- For details on how to set the original, refer to [User's Guide Copy].
- For details on how to set a double-sided original, refer to page 7-4.

- 2 Connect a USB memory to this machine.
The machine mode changes to scan mode and [TO: Scan to USB Memory] is displayed.

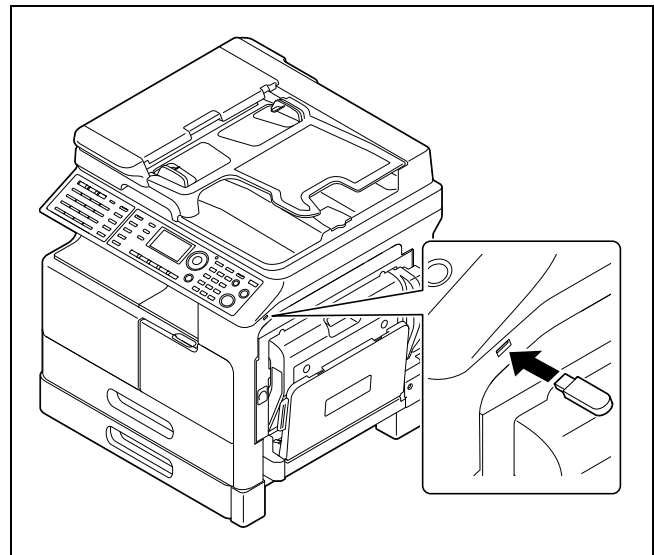

- By pressing ▼, file format, and compression coding method can be set. For details, refer to page 7-7.

- 3 Press the **Start** key.
Scanned original is stored in the USB memory.

Loading double-sided originals

- 1 Load the original.
→ For details on how to set the original, refer to [User's Guide Fax].
- 2 Press Simplex/Duplex.
A screen for specifying **Simplex/Duplex** appears.
- 3 Select [1-SIDE] or [2-SIDE] using ▲▼, then press **OK**.

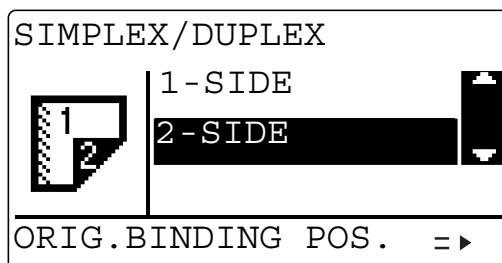

- When you select [2-SIDE] and press ►, you can specify the binding direction of the original. Select [LEFT] or [TOP], then press **OK**.

Tips

- The binding direction can be set only when you select [PDF] for the file format.

7.1.2 When setting an original on the Original Glass

- 1 Set the original onto the **Original Glass**.

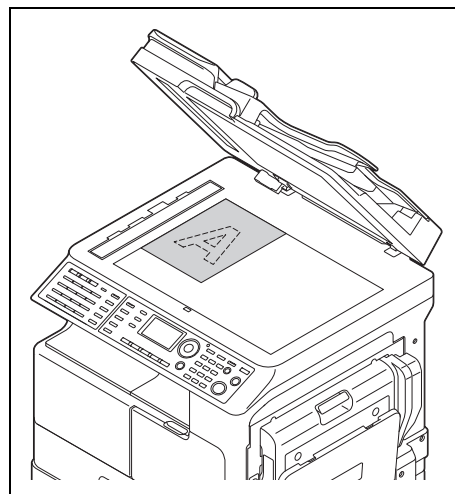

→ For details on how to set the original, refer to [User's Guide Copy].

- 2 Connect a USB memory to this machine.
The machine mode changes to scan mode and [TO: Scan to USB Memory] is displayed.

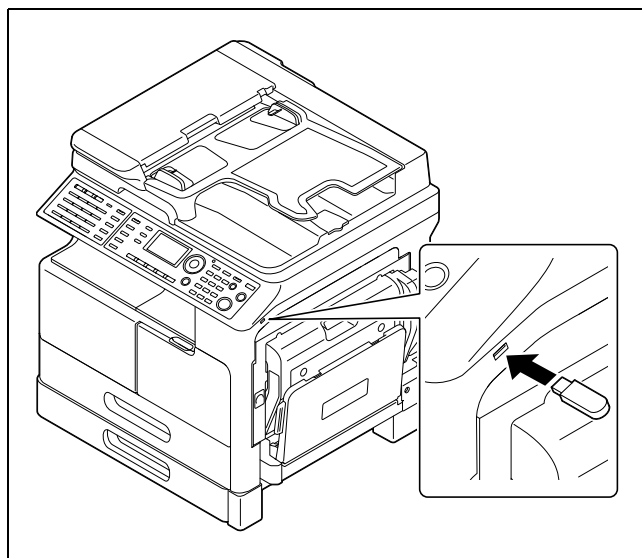

→ By pressing ▼, file format, and compression coding method can be set. For details, refer to page 7-7.

- 3 Press the **Start** key.
- 4 Press ▲▼, then select [AUTO DETECTION] or [MANUAL].
 - If [AUTO DETECTION] is selected, press **OK** and go to Step 8.
 - If [MANUAL] is selected, scanning size can be selected. Press ► and go to Step 6.
- 5 Press ▲▼ to select desired scanning size, then press **OK**.
 - By pressing [INCH] or [METRIC], the scanning size unit can be changed.
- 6 Press **OK**.

- 7 Check the content of setting, then press **OK**.
Scanning starts and [NEXT PAGE?] is displayed.

```
150dpiBW TIF 90%
TEXT/PHOTO  [AUTO]
NEXT PAGE? (AUTO)  1
-----
SCAN=OK (SEND=START)
```

- When scanning multiple sheets of the original, set the next original on the **Original Glass**, then press **OK**. Repeat the above procedure for all sheets of the original.

- 8 When all the originals have been scanned, press the **Start** key.
Storage starts.

Tips

- To stop scanning, press **Clear/Stop**.
- If you are unable to send data, the TX Result Report is output.



Reference

To cancel transmission of scanned data while standing by for transmission, press **Function** and select [CANCEL RESERV.]. For details, refer to [User's Guide Fax].

7.2 Changing the scan settings

You can change the setting for the file format and compression coding method.

7.2.1 Setting file format

- 1 Set the original and connect a USB memory to this machine.
The machine changes to the scan mode and [OTHER SETTING=▼] is displayed.
- 2 Press ▼.
The other setting screen appears.
- 3 Press ▲▼ to select [IMAGE FORMAT], then press **OK**.
- 4 Press ▲▼, then select file format.
 - The file format can be selected from [TIFF], [PDF], or [JPEG].
 - If [Color Setting] for [Quality] is set to [BW], [JPEG] is not displayed.
- 5 Press **OK**.
The screen returns to the other setting screen.

7.2.2 Setting compression coding method

- 1 Set the original and connect a USB memory to this machine.
The machine changes to the scan mode and [OTHER SETTING=▼] is displayed.
- 2 Press ▼.
The other setting screen appears.
- 3 Press ▲▼ to select [BW CODING METHOD], then press **OK**.
- 4 Press ▲▼, then select compression coding method.
 - Compression coding method can be selected from [MH], [MR], or [MMR].
- 5 Press **OK**.
The screen returns to the other setting screen.



PageScope Web Connection

8 PageScope Web Connection

8.1 Overview

PageScope Web Connection is a device control utility that is built into the printer controller of this machine. This utility can be used as an interface to control the machine remotely via the Web browser.

Tips

- To use **PageScope Web Connection**, **Network Card NC-504** or **Image Controller IC-209** must be installed on the machine.

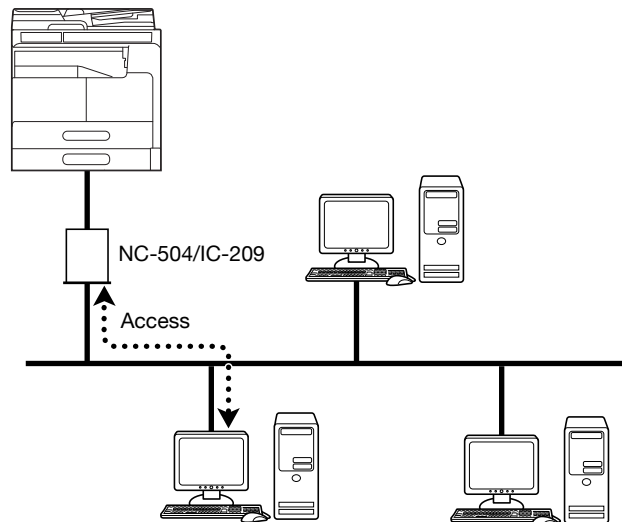

You can use **PageScope Web Connection** to perform the following tasks:

- Changing the settings
 - Registering the destination telephone numbers
 - Changing the printer settings
 - Changing the network settings
- Controlling the status remotely
 - Checking the tray, consumables, and total counter information
 - Checking print jobs (that can be deleted in administrator mode)
- Maintenance
 - Resetting both the **Network Card** and **Image Controller**
 - Initializing the **Network Card** and **Image Controller** to the factory default

8.1.1 Operating environments

Network	Ethernet (TCP/IP)
Operating systems	Windows Vista/7/8/8.1/Server 2008/Server 2008 R2/Server 2012/Server 2012 R2
Compatible Web browsers	Microsoft Internet Explorer 7 or later Mozilla Firefox 3.5/3.6 or later

8.2 How to use PageScope Web Connection

8.2.1 How to access

PageScope Web Connection can be accessed directly from the Web browser.

- 1 Start the Web browser.
- 2 Enter the IP address of this machine in the URL field as shown below, then press the Enter key.
 - http://<IP address for the machine>/
 - Example: When the IP address for the machine is 192.168.1.20
http://192.168.1.20/

Tips

- To access **PageScope Web Connection**, an IP address must be assigned to the machine.

8.2.2 How to view the screen

When you access **PageScope Web Connection**, the following screen appears.

Tips

- Screen images included in this document may differ from actual view. Note that the product specification is subject to change without notice.

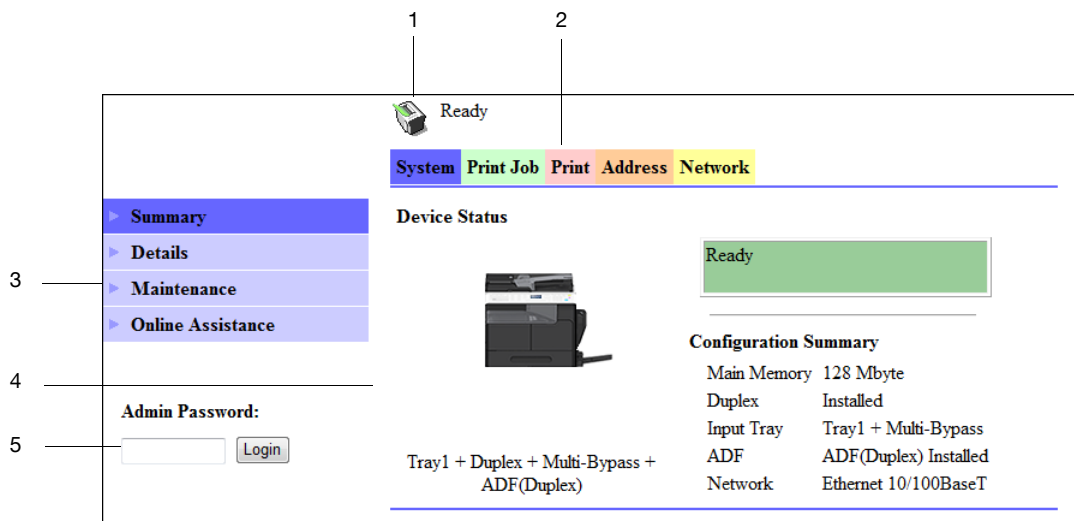

No.	Item	Description
1	Status display	The status of the machine is indicated by an icon and a message.
2	Tabs	Select the category of the item to be displayed. The following tabs are displayed in user mode. <ul style="list-style-type: none"> • System • Print Job • Print • Address • Network
3	Menu	Displays information and settings for the selected tab. The menu that appears in this area varies depending on which tab was selected.
4	Information and settings	Displays the details of the item selected in the menu.
5	Administrator Password	Enter the password to log into administrator mode.

Tips

- The [Print] tab is displayed only when **Image Controller IC-209** is installed.
- The contents of the **PageScope Web Connection** pages vary depending on the options installed on this machine or the settings of this machine.

8.2.3 User mode and administrator mode

PageScope Web Connection provides the user mode and administrator mode.

User mode

- This mode is available for all users. Only items that can be checked or operated on the user level are displayed in this mode.

Administrator Mode

- This mode is only available for administrators. Almost all items that can be configured or checked in **PageScope Web Connection** are displayed in this mode. Settings of each item can also be changed.

The screen first appears when you access **PageScope Web Connection** is for user mode.

To change the mode into administrator mode, enter the administrator password in the [Admin Password], then click [Login].

**Reference**

For details on administrator mode, refer to the [User's Guide Network Administrator].

8.2.4 How to operate

To operate **PageScope Web Connection**, click a tab to select a category of the desired function, then click the menu item to display the settings.

If the selected item is for view only, check the content in the area displaying the information and settings.

If the selected item is available for editing, edit the settings in the information and setting view.

To change the settings, click each tab and configure the necessary settings, then click [Apply]. The method to change settings may differ depending on the selected item. For details, refer to the page explaining the item.

PageScope Web Connection can be operated just like Internet Web pages. You can click a link in an Web page to jump to the destination, or click [Back] or [Forward] in the Web browser to view the previous or next page.

8.3 User mode

This section describes the usage for each menu item that is displayed at the left-hand side when you click a tab in user mode.

For details on administrator mode, refer to the [User's Guide Network Administrator].

8.3.1 [System] - [Summary]

This item displays the system configuration and status of the machine. This view first appears when you access **PageScope Web Connection** from the Web browser.

Ready

System Print Job Print Address Network

Summary
Details
Maintenance
Online Assistance

Admin Password:

Device Status

Ready

Tray1 + Duplex + Multi-Bypass + ADF(Duplex)

Configuration Summary

Main Memory	128 Mbyte
Duplex	Installed
Input Tray	Tray1 + Multi-Bypass
ADF	ADF(Duplex) Installed
Network	Ethernet 10/100BaseT

8.3.2 [System] - [Details]

You can check paper tray, output tray, ROM version, and interface information, as well as the status of consumables.

Ready

System Print Job Print Address Network

Summary
Details
Input Tray
Output Tray
ROM Version
Interface Information
Consumable
Maintenance
Online Assistance

Admin Password:

Input Tray

Tray	Paper Size	Media Type	Orientation	Capacity	Status
Tray1	A4	Plain	Shortedge	250	Ready
Multi-Bypass	A4	Plain	Longedge	100	Empty

Item	Description
[Input Tray]	Displays the installed tray names, paper size, paper type, orientation, the maximum capacity and status of each tray.

Item	Description
[Output Tray]	Displays the installed output tray names, the maximum capacity and status of each tray.
[ROM Version]	Displays the installed controller and its ROM version.
[Interface Information]	Displays the installed interfaces and its information.
[Consumable]	Displays information about consumables relevant to the machine.

Tips

- The items displayed may vary depending on options installed or settings.

8.3.3 [System] - [Maintenance] - [Counter]

Enables you to check the count information that is managed on this machine.

 Ready

System
Print Job
Print
Address
Network

▶ Summary

▶ Details

▼ Maintenance

▶ Counter

▶ Power Save Setting

▶ Online Assistance

Counter

Total Count	003647
Duplex Total Count	000420
Paper Size Count	000328

Admin Password:

8.3.4 [System] - [Maintenance] - [Power Save Setting]

Configure the settings related to transition to the Power Save mode.

Ready

System Print Job Print Address Network

Summary
Details
Maintenance
Counter
Power Save Setting
Online Assistance

Power Save Setting

Sleep Time 240 minute (1-240)

Enter Power Save Mode Normal

Apply Clear

Admin Password:
 Login

Configure the settings and click [Apply] to apply the change.

Item	Description
[Sleep Time]	Enter a time interval before the machine transitions to the Power Save mode after the last operation.
[Enter Power Save Mode]	Specify how the machine should enter the Power Save mode after printing out a received document. Setting this item to [Immediately] returns the machine to the Power Save mode immediately after receiving and outputting a print job while it is not being used (in the night for example), and thereby saves the electric power more efficiently. If [Normal] is selected, the machine returns to the Power Save mode according to the [Sleep Time] setting.

8.3.5 [System] - [Online Assistance]

This item displays the online assistance about this product.

Ready

System Print Job Print Address Network

Summary
Details
Maintenance
Online Assistance

Contact KONICA MINOLTA Customer Support

Contact Tel Number

Product Help URL <http://pagescope.com>

Corporate URL <http://konicaminolta.com>

Tel Number for Supplies / Accessories

Admin Password:
 Login

8.3.6 [Print Job] - [Print Job Management]

This item enables you to check details on print jobs.

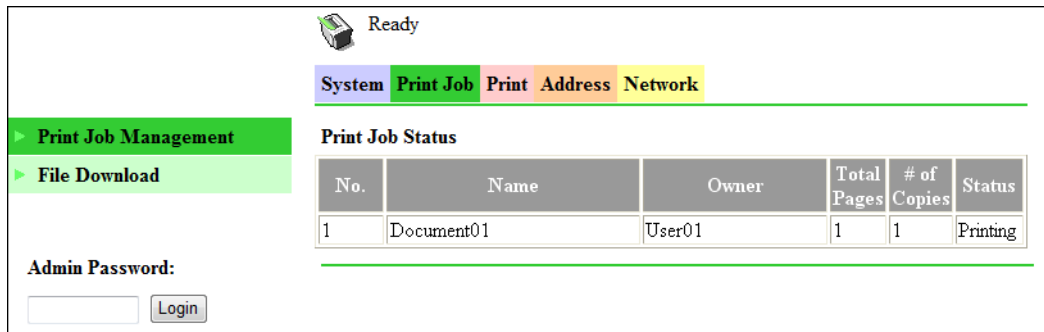

Ready

System **Print Job** Print Address Network

Print Job Management

File Download

Admin Password:

Print Job Status

No.	Name	Owner	Total Pages	# of Copies	Status
1	Document01	User01	1	1	Printing

Tips

- Up to 20 print jobs can be displayed. Completed print jobs are deleted automatically.
- Jobs specified as secure print are not displayed.
- The job number displayed here was assigned when the job was registered with the machine.
- To delete a print job, you must log into administrator mode.

8.3.7 [Print Job] - [File Download]

A PRN file created with the printer driver of this machine can be downloaded on to the machine and printed.

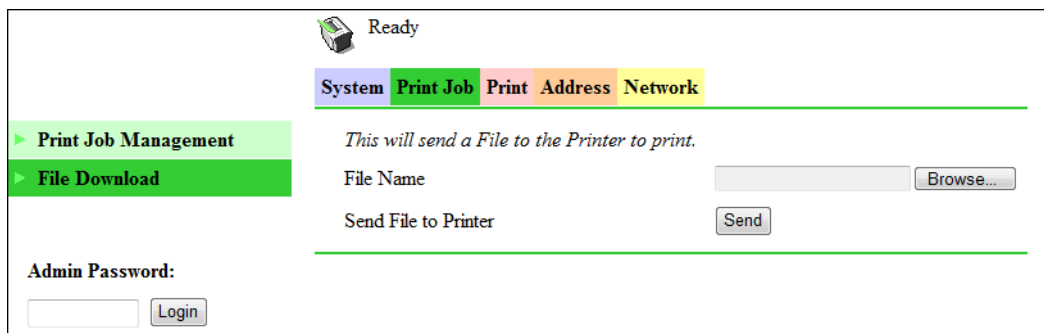

Ready

System **Print Job** Print Address Network

Print Job Management

File Download

Admin Password:

This will send a File to the Printer to print.

File Name

Send File to Printer

1 Click [Browse] and select a file.

2 Click [Send].

The file is downloaded on to the machine and printed.

Tips

- The following formats can be downloaded and printed depending on the option installation status.
 - No option: GDI and XPS PRN files
 - When **Image Controller IC-209** is installed: PCL and XPS PRN files, and ASCII text files
- If a file other than the above is downloaded, the characters will become garbled and will not print correctly.

8.3.8 [Print] - [Settings] - [Paper Handling]

This item enables you to check the settings relevant to the printer output.

If a print job is received with no settings configured, the job is printed in this setting.

Item	Description
[Copies]	Displays the specified number of copies.
[Paper Source]	Displays the selected paper tray.
[Media Path]	Displays the selected printing method.

Tips

- The [Print] tab is displayed only when **Image Controller IC-209** is installed.

8.3.9 [Print] - [Settings] - [Paper Layout]

This item enables you to check the paper size specified for the output paper size of the printer.

If a print job is received with no settings configured, the job is printed in this setting.

Tips

- The [Print] tab is displayed only when **Image Controller IC-209** is installed.

8.3.10 [Print] - [Settings] - [Printer Setting]

This item enables you to check the settings relevant to the PCL function of the printer.

If a print job is received with no settings configured, the job is printed in this setting.

The screenshot shows the printer's web interface. At the top, there is a 'Ready' status indicator with a printer icon. Below it, a navigation bar contains five tabs: 'System' (blue), 'Print Job' (green), 'Print' (red, active), 'Address' (orange), and 'Network' (yellow). A left-hand menu is expanded to show 'Settings' (red), with sub-items: 'Paper Handling' (pink), 'Page Layout' (pink), 'Printer Setting' (red, active), 'Test Print' (pink), and 'Font Information' (pink). The main content area is titled 'PCL Settings' and contains the following configuration options:

- Orientation: Portrait Landscape
- Size: (4.00-999.75)
- Pitch: (0.44-99.99)
- Font No.: (1-53)
- Symbol Set: (dropdown menu)
- Form Length: (5-128)

At the bottom left, there is an 'Admin Password:' label, a text input field, and a 'Login' button.

Item	Description
[Orientation]	Select the paper orientation.
[Size]	Displays the specified font size.
[Pitch]	Displays the specified font pitch.
[Font No.]	Displays the specified font number.
[Symbol Set]	Displays the selected symbol set.
[Form Length]	Displays the specified page length.

Tips

- The [Print] tab is displayed only when **Image Controller IC-209** is installed.

8.3.11 [Print] - [Test Print]

This item enables you to print the following test pages.

- Configuration Page
- PCL Font List

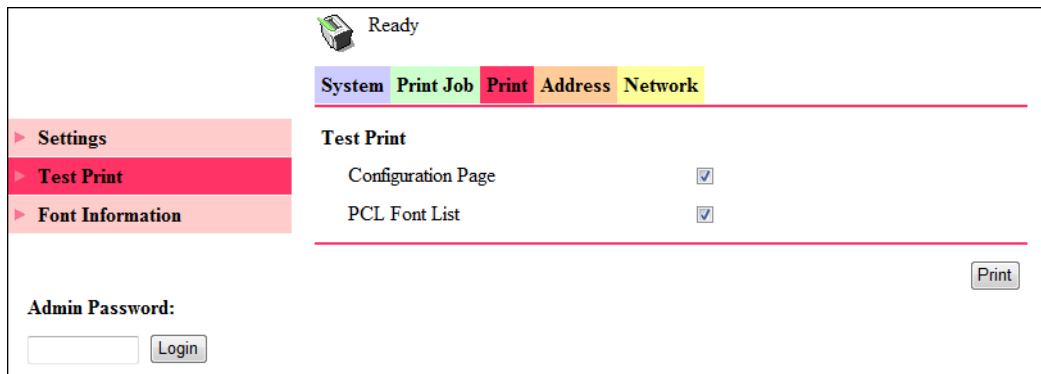

- 1 On the [Print] tab, click [Test Print].
 - 2 Select the test page you want to print.
 - 3 Click [Print].
- The selected test page is printed out.

Tips

- The [Print] tab is displayed only when **Image Controller IC-209** is installed.

8.3.12 [Print] - [Font Information]

This item enables you to check the PCL font list.

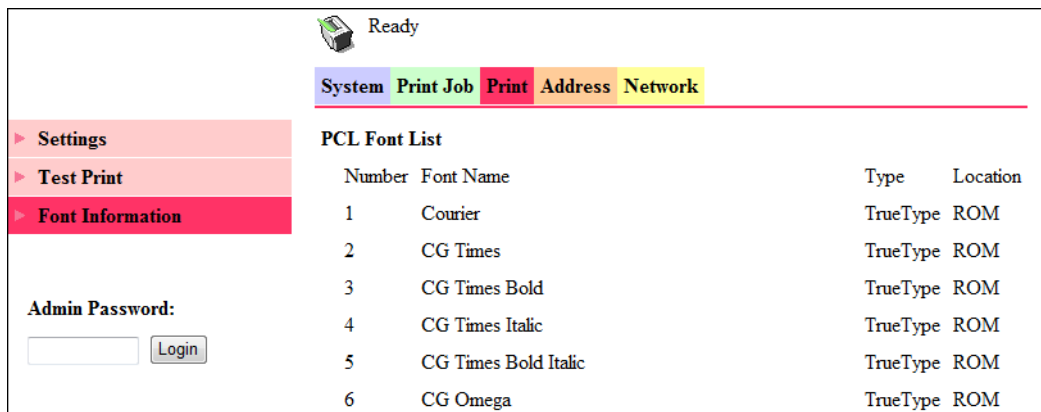

Tips

- The [Print] tab is displayed only when **Image Controller IC-209** is installed.

8.3.13 [Address] - [One-Touch Dial Setting]

This item enables you to check the registered One-touch Dial settings.

 Ready

System
Print Job
Print
Address
Network

- ▶ One-Touch Dial Setting
- ▶ Speed Dial Setting
- ▶ Group Dial Setting

Admin Password:

One-Touch Dial List

No.	Name	Address	Batch
01	Sales A	0123456789	-
02	Sales B	sales_b@abc.com	-
03	ALL Sales	(Group Dial)	-
04	-	-	-
05	-	-	-
06	-	-	-

8.3.14 [Address] - [Speed Dial Setting]

This item enables you to check the registered speed dial settings.

 Ready

System
Print Job
Print
Address
Network

- ▶ One-Touch Dial Setting
- ▶ Speed Dial Setting
- ▶ Group Dial Setting

Admin Password:

Speed Dial Index

001-020	021-040	041-060	061-080	081-100
101-120	121-140	141-160	161-180	181-200
201-220	221-240	241-250		

Speed Dial Index (Scan to Server)

251-270	271-290	291-300
---------	---------	---------

Speed 001-020 Top

No.	Name	Address
001	Email 192.168.0.20	user01@test.local
002	Sales B	1234567890
003	-	-
004	-	-
005	-	-
006	-	-

8.3.15 [Address] - [Group Dial Setting]

This item enables you to check the registered group dial settings.

 Ready

System
Print Job
Print
Address
Network

- ▶ One-Touch Dial Setting
- ▶ Speed Dial Setting
- ▶ **Group Dial Setting**

Admin Password:

Group Dial List

No.	Name	Address
01	Sales A	(Fax)
02	Sales B	(E-Mail)
03	ALL Sales	(Group Dial)
04	-	-
05	-	-
06	-	-

8.3.16 [Network] - [Summary]

This item enables you to check the basic network settings.

 Ready

System
Print Job
Print
Address
Network

- ▶ **Summary**

Admin Password:

Summary

Device Name	Ethernet 10/100BaseT
ROM Version	A3PE0778-3000-E00-26
IP Address	192.168.1.200
Hardware Address	08:20:8c:33:88:6c



Troubleshooting

9 Troubleshooting

9.1 Error of TWAIN driver

Message	Cause	Correction action
Control Panel: [PC CONNECTION FAILED] Computer: [Read Data Error] [Scanner not ready]	<ul style="list-style-type: none"> This machine has not started. A system crash occurred on the computer or the machine during transmission. Either USB cable or network cable failed to be correctly connected during transmission. 	(1) Turn the machine OFF and check that the USB cable and network cable are connected correctly. (2) If the USB cable and network cable connections are found in order, turn the machine ON again. (3) If the problem persists, contact your service representative.
Control Panel: [Original. doc.jam] Computer: [Document JAM on machine]	<ul style="list-style-type: none"> Paper jam inside the ADF. Jammed paper has not been completely removed from the ADF. 	<ul style="list-style-type: none"> Open the Left Cover and the ADF and remove all jammed paper. For details on remedial actions, refer to [User's Guide Copy]. When all jammed paper is removed, the memory size (in %) returns to the initial value.
Computer: [Scanner Busy]	<ul style="list-style-type: none"> If TWAIN scan and a copying job are run simultaneously, this machine may stop during scan processing. 	<ul style="list-style-type: none"> Wait until the copying or scanning process ends.
Control Panel: (Different messages appear depending on the type of error.) Computer: [Machine error]	<ul style="list-style-type: none"> While scanning with the ADF, either the ADF or Left Cover is open. A problem exists with the command transmission between TWAIN driver and this machine. 	<ul style="list-style-type: none"> For details, refer to [User's Guide Copy]. When all jammed paper is removed, the memory size (in %) returns to the initial value. Check this machine and the USB cable or Network cable.
Computer: [Read Data Error]	<ul style="list-style-type: none"> An error has occurred while scanning data from this machine. 	(1) Turn the machine OFF and check that the USB cable and network cable are connected correctly. (2) If the USB cable and network cable connections are found in order, turn the machine ON again. (3) If the problem persists, contact your service representative.
Control Panel: [SET ORIGINAL TO ADF] Computer: [ADF (Duplex) No Paper]	<ul style="list-style-type: none"> The original is not set on the ADF. 	<ul style="list-style-type: none"> Set the original on the ADF.

Tips

- Checking of the network cable is available only when optional **Network Card NC-504** or **Image Controller IC-209** is installed.
- The **ADF** is an option.

9.2 Error of network scan

Tips

- Network scan requires the machine to have either optional **Network Card NC-504** or **Image Controller IC-209** and **Extended Operation Panel MK-749** installed.

Message	Cause	Correction action
[COMMUNICATION ERROR] [XXXX Server]	Communication with the server failed due to a problem in the machine or the unavailability of the network or server.	Check the communication result report. Contact your network administrator.
[CANNOT CONNECT] [XXXX Server]	A connection with the server could not be established.	Make sure that the Ethernet cable is correctly connected. Check the settings of each server and network. Contact your network administrator.
[CANNOT GET IP] [XXXX Server]	An IP address could not be obtained from the DNS server.	Contact your network administrator.
[DISCONNECT] [XXXX Server]	The connection with the server has been severed.	Contact your network administrator.
[WRONG PASSWORD] [XXXX Server]	Login to the server failed due to use of an incorrect password.	Check the POP3 server settings. Contact your network administrator.
[MEMORY FULL]	Image data has caused a memory overflow during E-mail transmission.	Remove the transmitted data stored in the memory.
[MEMORY FILE FULL]	The maximum number of files has been used during E-mail transmission.	Remove the transmitted data stored in the memory.
[SERVER MEMORY FULL] [SMTP Server]	A memory overflow occurred in the SMTP server during E-mail transmission.	Contact your network administrator.
[XXX SERVER ERROR]	Scanned data could not be correctly uploaded to the FTP server or the SMB server.	Contact your network administrator.

9.2.1 If you suspect a failure then do the following

Case examples	Cause	Correction action	Reference
Unable to transmit	A connection has not been made.	Check the hub lamp indication to ensure the connection status	[User's Guide Network Administrator]
	Necessary setting for the machine is not registered.	Configure necessary network setting.	[User's Guide Network Administrator]
	The LAN cable is broken.	Replace the LAN cable.	-
Transmission is enabled but no images have been output to the terminal or computer at the destination.	The destination terminal has no processing capacity for transmitted images.	Configure the size, image quality and compression coding method settings supported by the destination terminal and send data again.	p. 5-7 p. 5-10
	Transmitting document without inserting the text.	Depending on the software, the attached file may be invisible if a mail containing only an attached file (no text) is received. In this case, have the destination party re-transmit data that is configured to allow insertion of text.	[User's Guide Network Administrator]

9.3 Error of Scan to USB

Message	Cause	Correction action
[USB MEMORY FULL]	The memory capacity of the USB is less than the data size to be scanned.	Either increase the amount of available space by deleting files on the USB memory, or use another USB memory that has more available memory space.
[USB Dev. Not support]	A non-USB memory stick or a type of USB memory that cannot be written to (a write-protected one) is used.	Use a writable USB memory stick.
[USB Hub Not support]	USB hubs are not supported.	Remove the USB hub and insert a USB memory stick.
[COMMUNICATION ERROR] [USB Memory]	Communication with the USB memory could not be established.	Check that the USB memory is connected correctly.
[DISCONNECT] [USB Memory]	The connection to the USB memory has been interrupted.	Check that the USB memory is connected correctly.

10

Appendix

10 Appendix

10.1 Main product specifications

10.1.1 Network scan

Tips

- Network scan requires the machine to have either optional **Network Card NC-504** or **Image Controller IC-209** and **Extended Operation Panel MK-749** installed.

Item	Specifications
Communication protocol	Scan to E-mail: SMTP, TCP/IP Scan to Server (FTP): FTP, TCP/IP Scan to Server (SMB): SMB, TCP/IP
Resolution	BW: 150×150 dpi, 300×300 dpi, 600×600 dpi Gray and Color: 150×150 dpi, 300×300 dpi
Data format	Mail format: MIME Attached file format: TIFF, PDF and JPEG
Compression coding method	BW: MH, MR, MMR Gray and Color: JPEG
Network	Ethernet LAN (10BASE-T, 100BASE-TX connection)

10.1.2 Scan to USB

Item	Specifications
File system	FAT16 / FAT32
Maximum capacity of USB memory	4GB
Resolution	BW: 150×150 dpi, 300×300 dpi, 600×600 dpi Gray and Color: 150×150 dpi, 300×300 dpi
Data format	TIFF, PDF and JPEG
Compression coding method	BW: MH, MR, MMR Gray and Color: JPEG

11 **Index**

11 Index

11.1 Index by item

C

- CC address *5-7*
- Color *5-10, 5-14*
- Communication Results *5-21*
- Compression Coding Method *5-13, 6-7, 7-7*
- Compression coding method *5-7*

F

- File format *5-7, 5-13, 6-7, 7-7*

G

- Group dial *4-7, 4-9*

I

- Initial value *5-13*

N

- Network scan *2-5*

O

- One-touch Dial *4-4, 4-8*
- Original Type *5-10*

P

- PageScope Web Connection *8-3*
- Phone Book *5-19*
- Photo Mode *5-12*
- Pull Scan *3-4*
- Push Scan *3-4*

R

- Resolution *5-10, 5-13*

S

- Scan *2-3, 3-4*
- Scan to E-mail *2-5, 5-3*
- Scan to Server *6-3*
- Scan to Server (FTP) *2-6*
- Scan to Server (SMB) *2-7*
- Scan to USB *7-3*
- Setting driver *3-4, 3-8*
- Speed dial *4-5, 4-8*
- Subject *5-7*

T

- Test/Photo, Text Mode *5-11*
- TWAIN driver *3-3*

U

- USB Memory *7-3*

W

- WIA driver *3-8*

11.2 Index by button

A

AddressBook *5-19*

B

Brightness/Contrast *3-7*

Brightness/Contrast, Sharp, Curves, Level, Color Balance, Hue/Saturation, Default *3-4*

BW CODING METHOD *5-9, 5-13, 7-7*

C

CC ADDRESS *5-7*

Clear *3-5, 3-6*

Color Balance *3-7*

COLOR SETTING *5-10*

Copies *8-10*

Counter *8-7*

Curves *3-7*

D

Default *3-7*

Details *8-6*

Document Size *3-4, 3-5*

Duplex Scanning *3-4*

E

Enter Power Save Mode *8-8*

F

File Download *8-9*

Font Information *8-12*

Font No. *8-11*

Form Length *8-11*

Full Color *3-5*

G

Grey *3-5*

GROUP DIAL *4-7, 4-9*

Group Dial Setting *8-14*

H

Hue/Saturation *3-7*

I

IMAGE FORMAT *5-8, 5-13, 7-7*

Image Size *3-5*

Image size *3-4*

L

LAN/USB *3-4, 3-6*

LDAP SEARCH *4-4, 4-5, 5-20*

Levels *3-7*

M

Maintenance *8-7, 8-8*

Manual *3-4*

MANUAL SETTING *4-4, 4-5*

Media Path *8-10*

O

ONE-TOUCH DIAL *4-4, 4-8*

One-Touch Dial Setting *8-13*

Online Assistance *8-8*

Orientation *8-11*

ORIGINAL *5-10*

P

PageScope Web Connection *8-3*

Paper Handling *8-10*

Paper Layout *8-10*

Paper Source *8-10*

PHOTO *5-12*

Photo *3-5*

Pitch *8-11*

Power Save Setting *8-8*

Prescan *3-5, 3-6*

Preview *3-9*

Print Job Management *8-9*

Printer Setting *8-11*

Pull Scan *3-5*

R

RESOLUTION *5-10, 5-13*

Resolution *3-4, 3-5*

S

Scan *3-4, 3-6*

Scan Mode *3-4, 3-5*

Scan Type *3-4, 3-5*

Scanning Mode *3-4, 3-7*

Scanning mode *3-4*

Search *3-6*

Settings *8-10, 8-11*

Sharp *3-7*

Size *8-11*

Sleep Time *8-8*

SPEED DIAL *4-5, 4-8*

Speed Dial *5-17*

Speed Dial Setting *8-13*

SUBJECT *5-7*

Summary *8-6, 8-14*

Symbol Set *8-11*

T

Test Print *8-12*

TEXT *5-11*

Text *3-5*

TEXT/PHOTO *5-11*

TX/RX RESULT *5-21*

U

Unit *3-5, 3-6*