



Make It Yours.

MASTERCASE MC600P

User manual / English

التثبيت دليل / Arabic

Инструкция за експлоатация / Български

安装说明 / 简体中文

安裝說明 / 繁體中文

Užívateľská príručka / Čeština

Handuch / Deutsch

Εγχειρίδιο χρήσης / Ελληνικά

Manual de Usuario / Español

Manuel de l'utilisateur / Français

Felhasználói kézikönyv / Magyar

Manuale d'uso / Italiano

ユーザーズマニュアル / 日本語

Handleiding / Nederlands

설치 안내 / Korean

Instrukcja Użytkownika / Polski

Manual do Usuário / Português



Руководство пользователя / русский

Uputstvo za korišćenje / Srpski

Kullanım Kılavuzu / Türkçe

Panduan Pengguna / Indonesia

1. PACKAGE CONTENT

Item	Pics	Name	Q'ty	Used for
01		#6 - 32*32 Screw	12	360mm Radiator
02		#6 - 32*29 Screw	4	Front Fan
03		Stand-off Socket	1	M / B Tray
04		Stand-off	7	M / B Tray
05		#6 - 32*10 Screw	4	HDD Cage
06		#6 - 32*5 Screw	15	PSU / Fan Cage / M / B Tray
07		Cleaning Cloth	1	Cleaning Glass
08		#6 - 32*6 Screw	2	HDD Cage
09		Cable Tie	10	Cable Management
10		M3*5 Screw	4	ODD
11		TOP Fan Cage	1	Lock Bracket/360mm Radiator
12		Ø5*10 Screw	8	Top Fan
13		M3*4 Screw	20	2.5" SSD
14		3 to 4 Cable	3	Connect to Fan
15		Velcro Cable Management Strap	2	Cable Management
16		M3*4 Screw	4	Fan Controller Bracket Screw
17		Ø3*6 Screw	4	Fan Controller Bracket Screw
18		Ø3*8 Screw	4	Fan Controller Bracket Screw
19		5.25" Bridging Connector	2	Fan Controller Bracket
20		RGB Extension Cable	1	Control Board

2. COMPATIBILITY

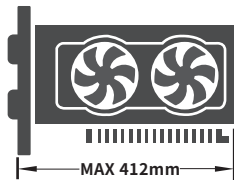
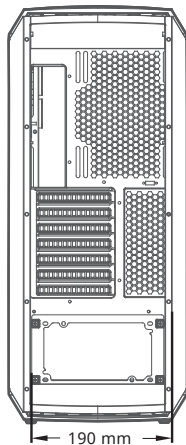
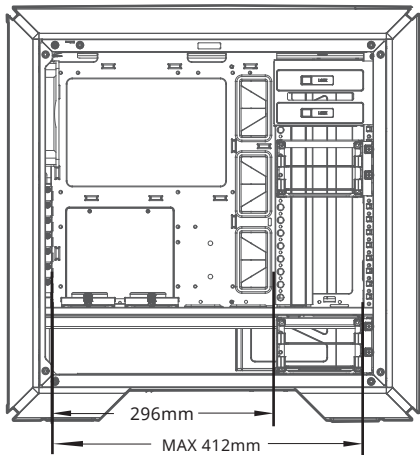

3. MOTHERBOARD INSTALLATION

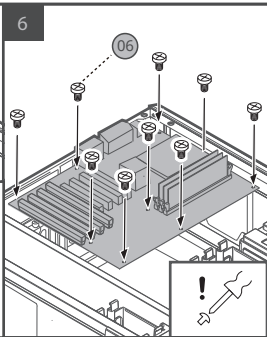
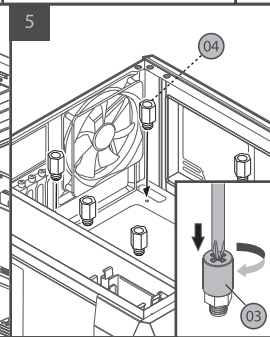
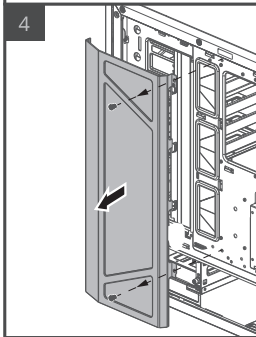
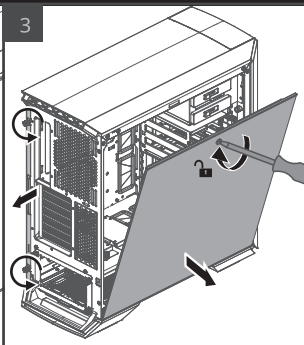
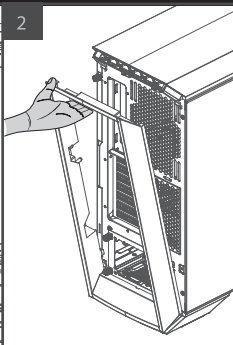
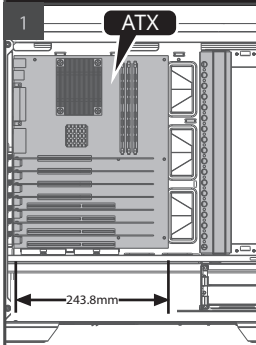

4. MOTHERBOARD INSTALLATION

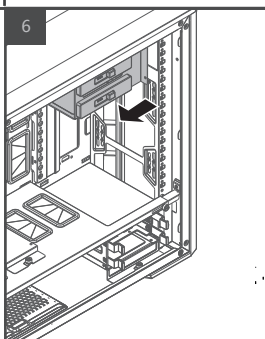
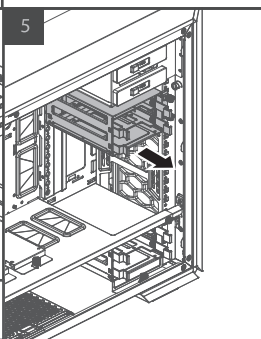
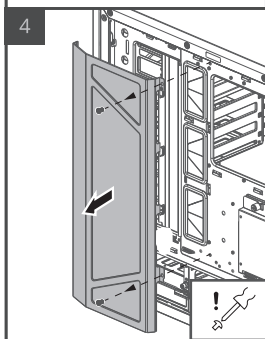
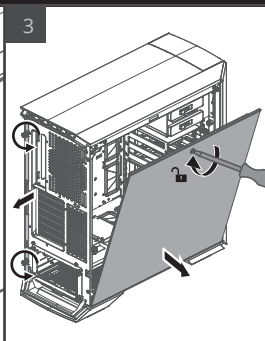
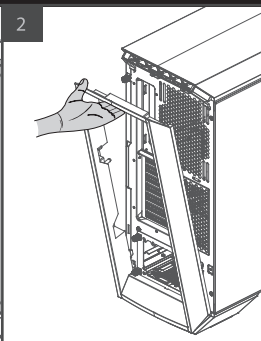
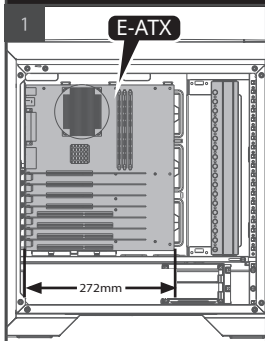

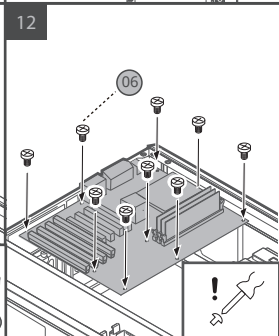
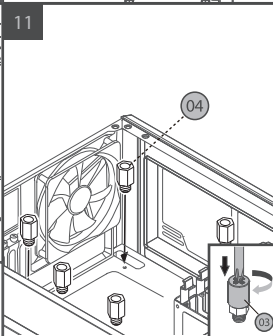
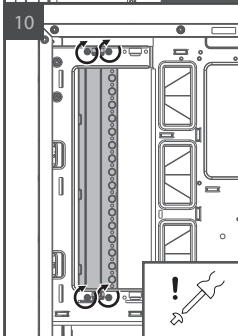
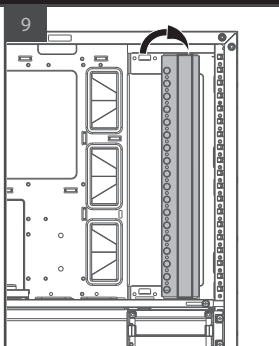
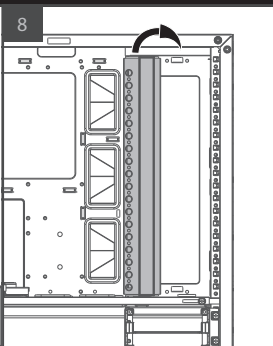
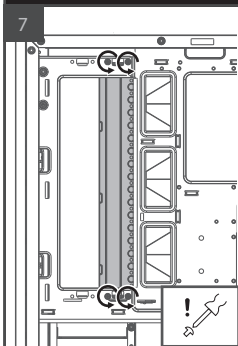

5. POWER SUPPLY INSTALLATION

1

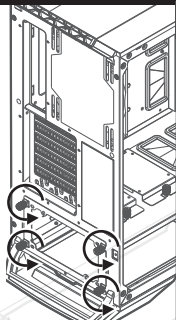

2

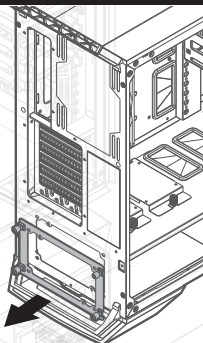

3

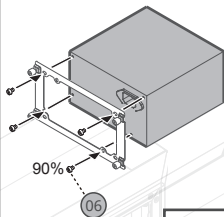

4

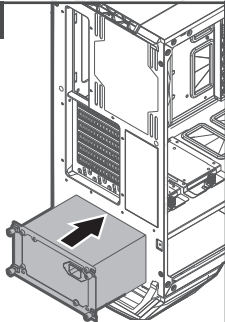

5

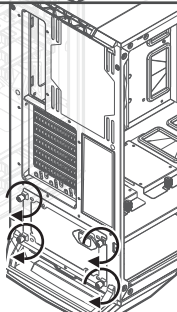

6

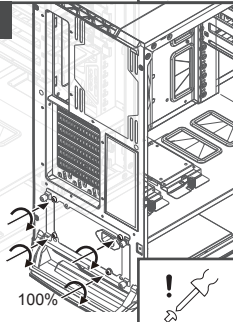

6. HARD DRIVE INSTALLATION

1 A. 2.5" HDD/SSD

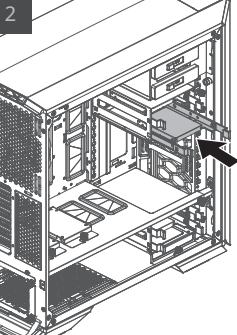
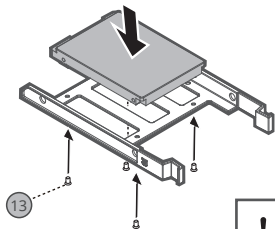

1 B. 3.5" HDD

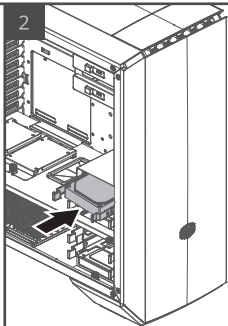
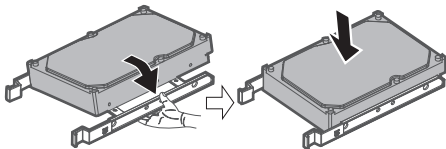

7. HARD DRIVE INSTALLATION

1 C. 2.5" HDD/SSD

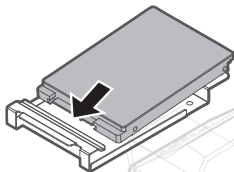

2

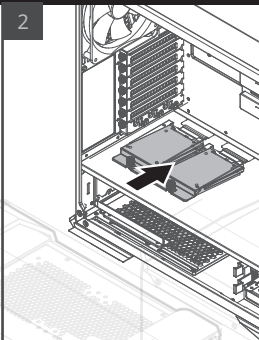

3

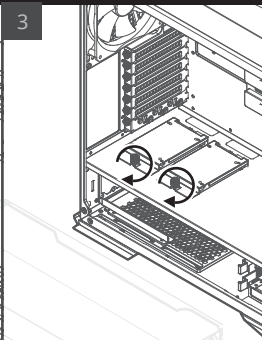

1 C. 2.5" HDD/SSD

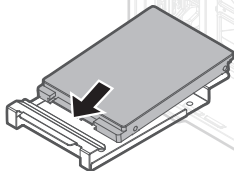

2

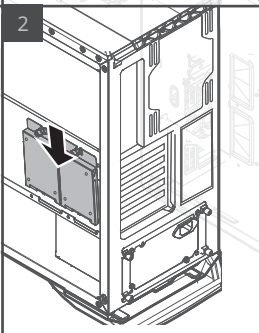

3

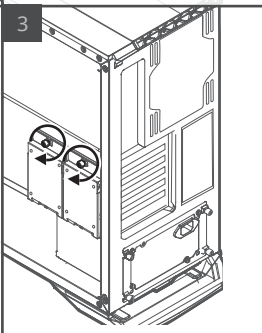

8. OPTICAL DRIVE INSTALLATION

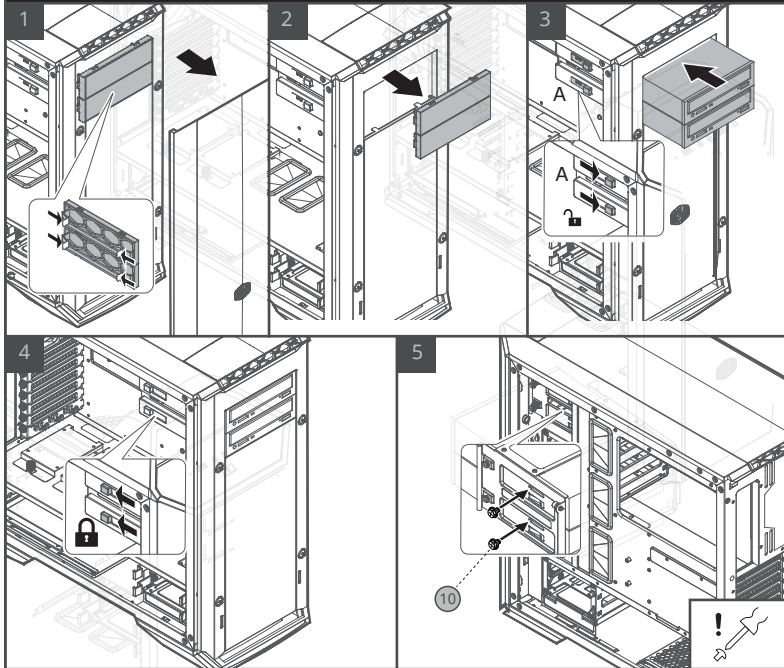

9. 5.25" BAY REMOVAL

1

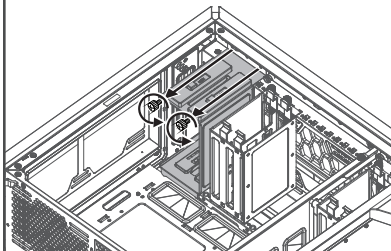

2

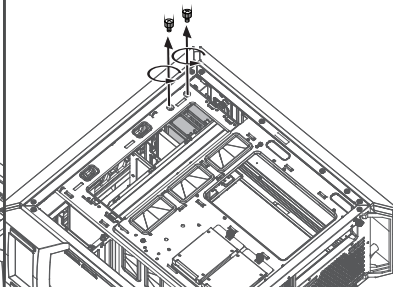

3

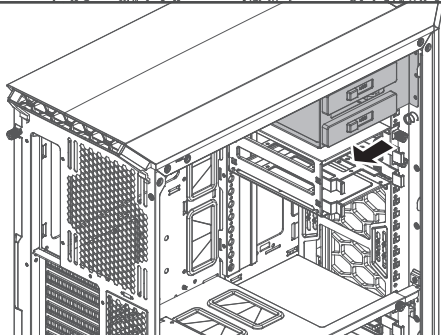

10. HARD DRIVE CAGE ADJUSTMENT

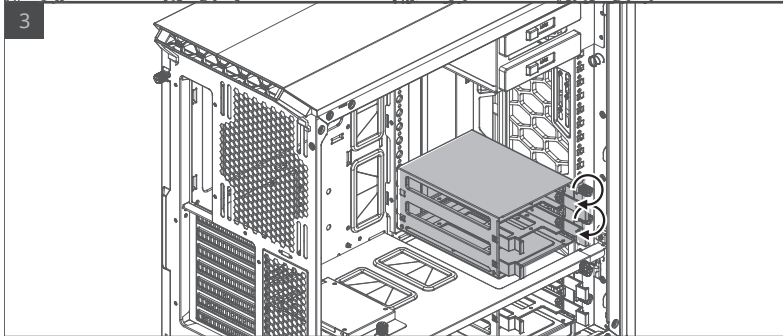
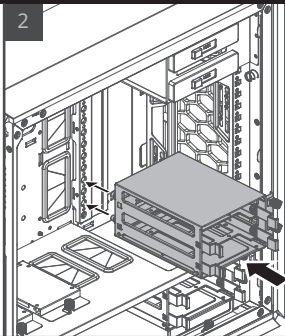
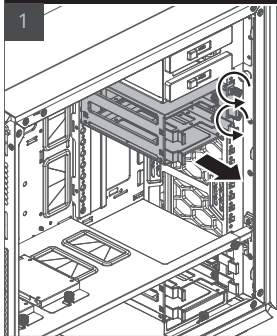

11. HARD DRIVE CAGE ADJUSTMENT

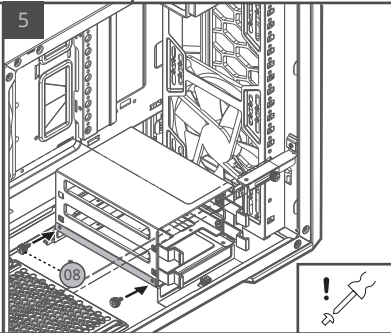
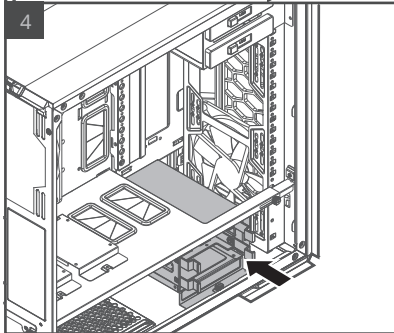
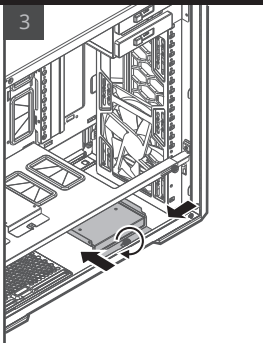
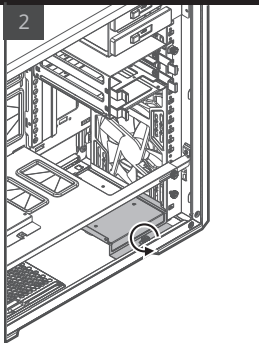
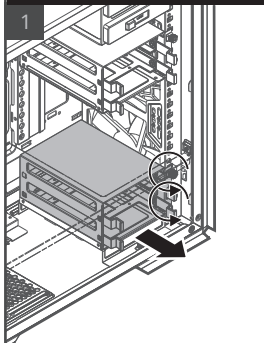

12. FRONT FAN INSTALLATION

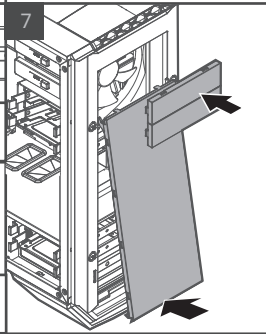
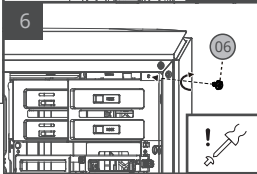
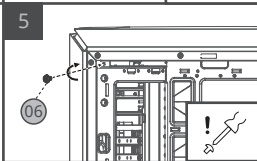
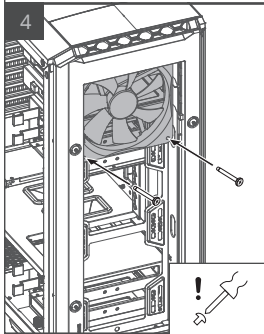
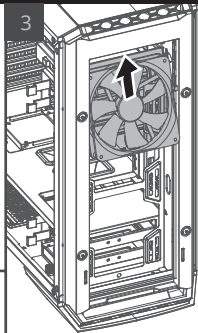
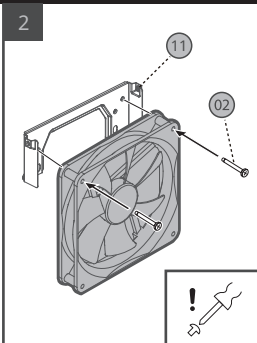
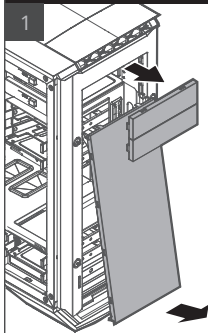

13. TOP AND REAR FAN INSTALLATION

1

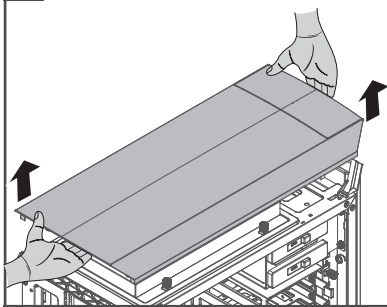

2

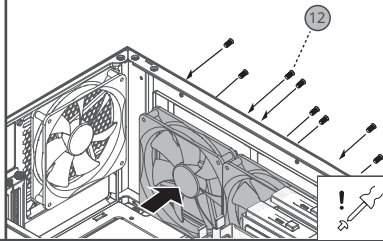

3

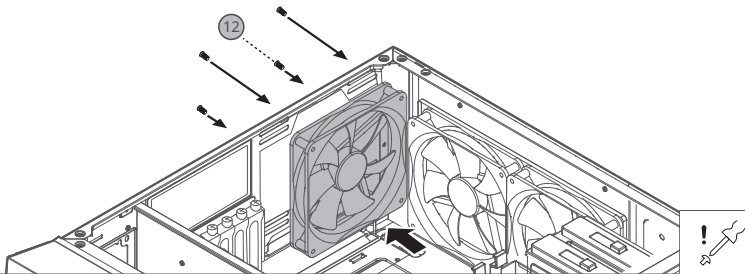

14. FRONT RADIATOR INSTALLATION (240/280mm)

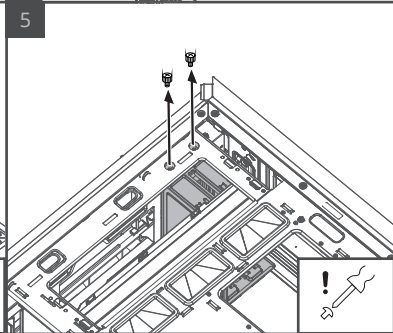
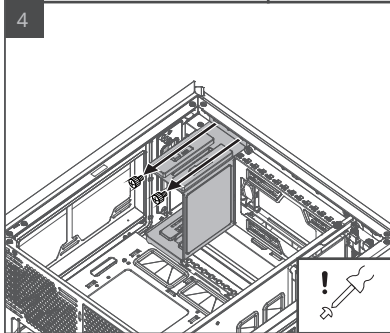
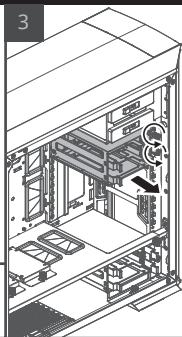
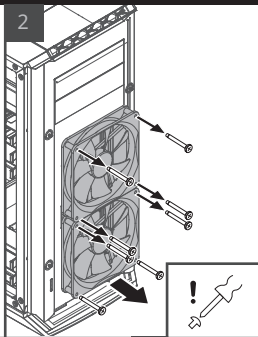
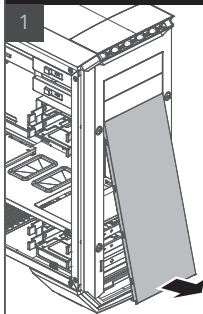

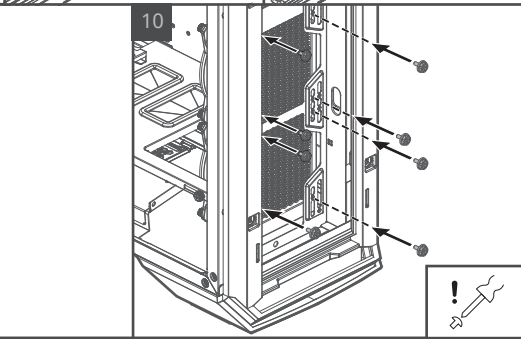
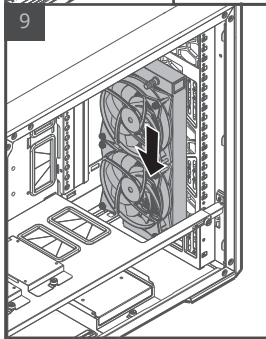
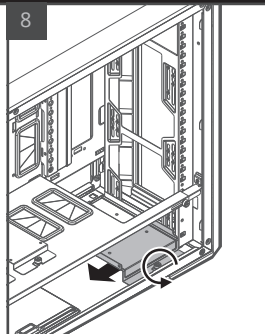
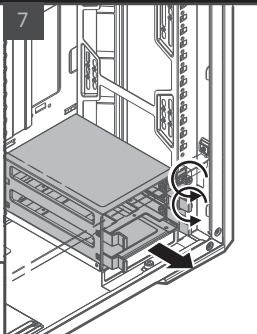
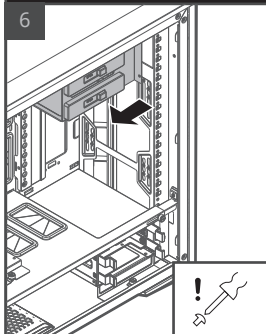

15. FRONT RADIATOR INSTALLATION (360mm)

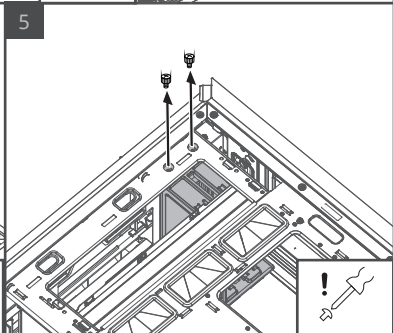
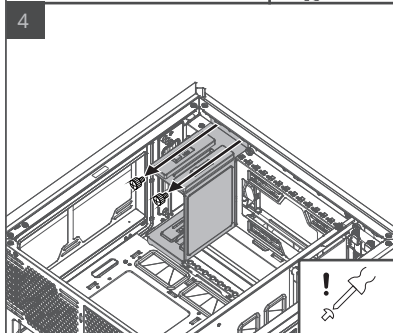
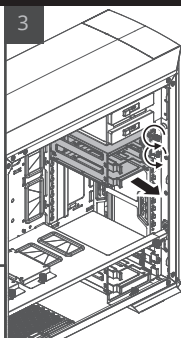
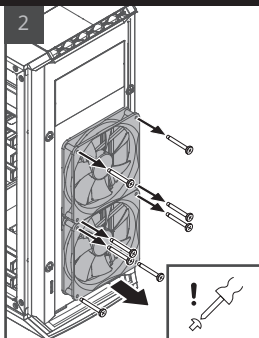
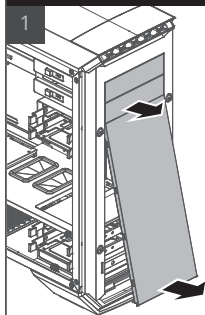

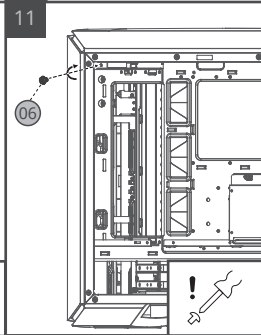
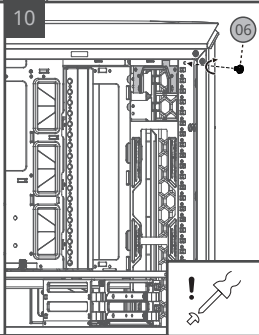
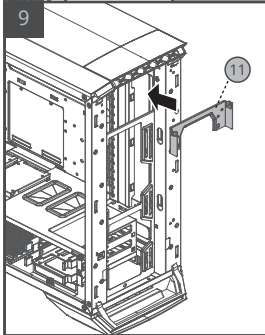
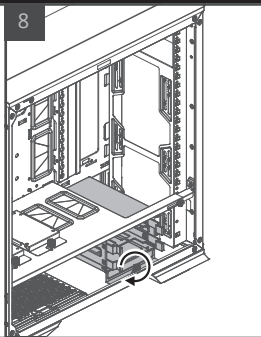
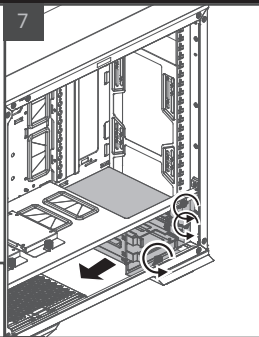
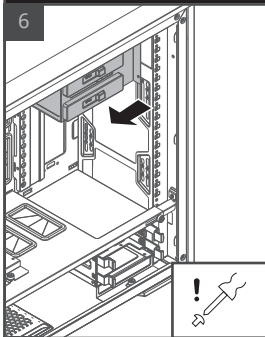

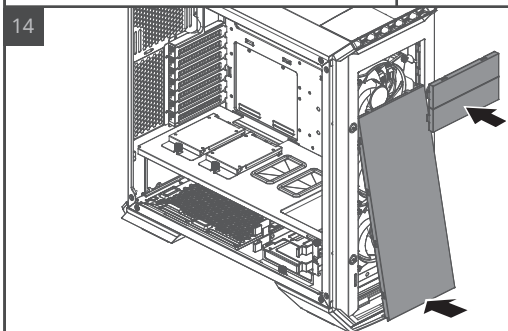
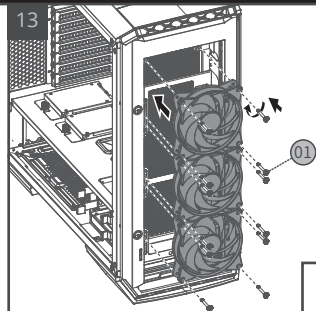
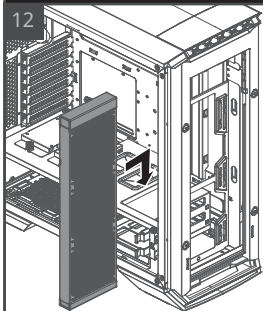

16. TOP RADIATOR INSTALLATION

1

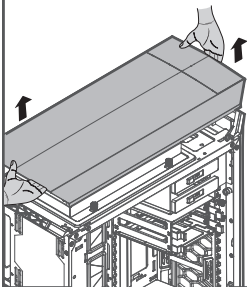

2

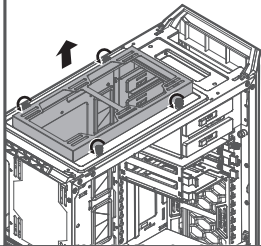

3

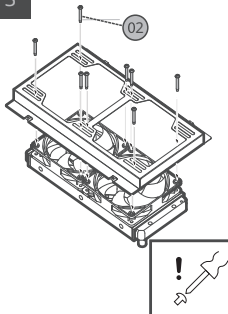

4

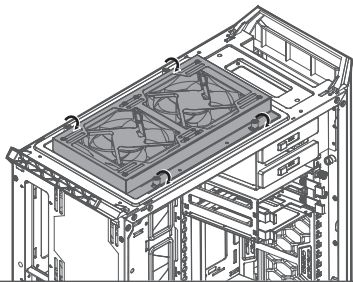

5

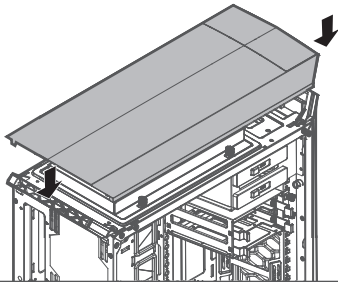

17. REAR RADIATOR INSTALLATION

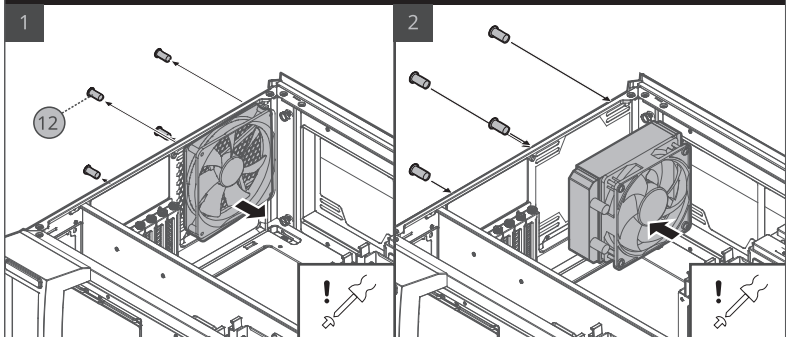

18. FRONT LED INSTALLATION

1

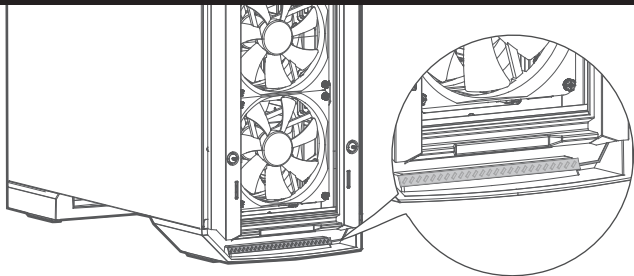

2

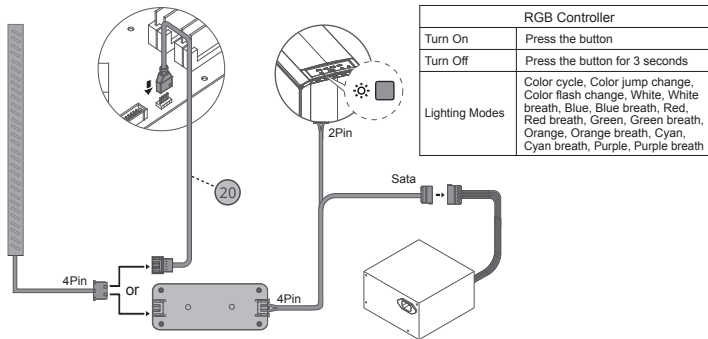

19. REMOVE PARTITION PLATE

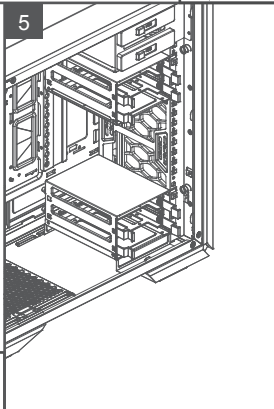
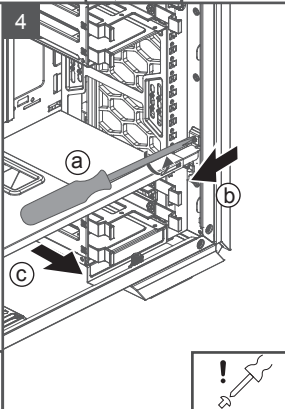
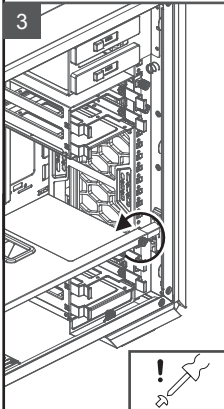
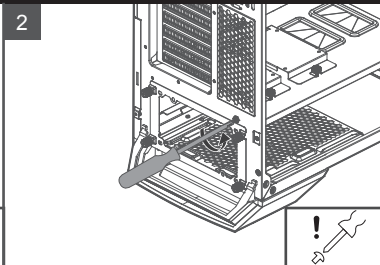
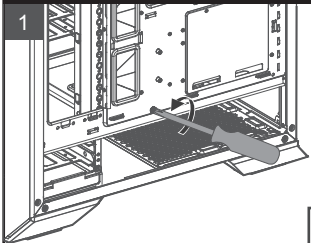

20. FAN CONTROLLER INSTALLATION

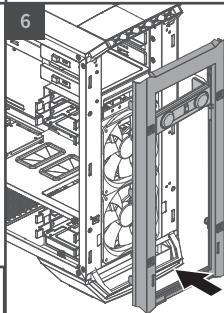
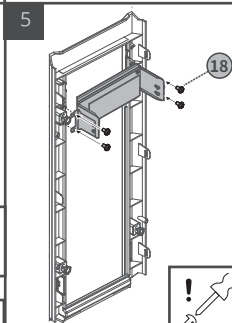
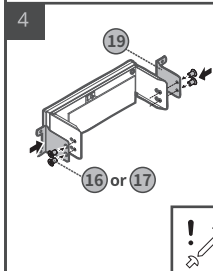
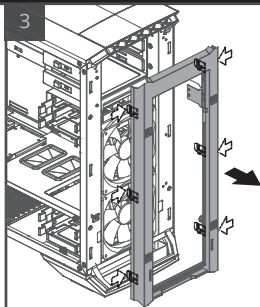
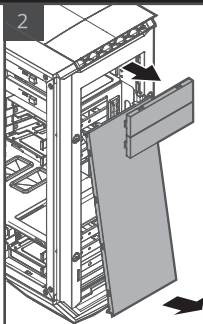
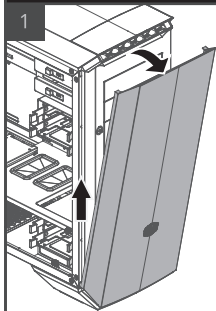

Note (16) SECC (17) ABS

English (EN)

1. Package content
2. compatibility
3. motherboard installation
4. motherboard installation
5. power supply installation
6. hard drive installation
7. hard drive installation
8. optical drive installation
9. 5.25" bay removal
10. hard drive cage adjustment
11. hard drive cage adjustment
12. front fan installation
13. top and rear fan installation
14. front radiator installation (240/280mm)
15. front radiator installation (360mm)
16. top radiator installation
17. rear radiator installation
18. Front LED Installation
19. remove partition plate
20. Fan Controller Installation

German (DE)

1. Lieferumfang
2. Kompatibilität
3. Installation der Hauptplatine
4. Installation der Hauptplatine
5. Installation des Netzteils
6. Installation der Festplatte
7. Installation der Festplatte
8. Installation des optischen Laufwerks
9. 5.25" Schacht entfernen
10. Festplattenkäfig anpassen
11. Festplattenkäfig anpassen
12. Installation von Front-Lüfter
13. Installation von Heck- und Top-Lüfter
14. Installation eines Front-Radiators (240/280mm)
15. Installation eines Front-Radiators (360mm)
16. Installation eines Top-Radiators
17. Installation eines Heck-Radiators
18. Installation eines Front-LED
19. Entfernen der Trennplatte
20. INSTALLATION DER LÜFTERSTEUERUNG

Spanish (ES)

1. Contenido de la confección
2. Compatibilidad
3. Instalación tarjeta madre
4. Instalación tarjeta madre
5. Instalación alimentador
6. Instalación Hard Drive
7. Instalación Hard Drive
8. Instalación Drive Óptico
9. Extracción Bay 5.25"
10. Regulación cesto para Hard Drive
11. Regulación cesto para Hard Drive
12. Instalación ventilador frontal
13. Instalación ventilador Superior y Posterior
14. Instalación Radiador Frontal (240/280mm)
15. Instalación Radiador Frontal (360mm)
16. Instalación Radiador Superior
17. Instalación Radiador Posterior
18. Instalación LED Frontal
19. Quitar la placa de separación
20. **INSTALACIÓN CONTROL VENTILADOR**

French (FR)

1. Contenu de l'emballage
2. Compatibilité
3. Installation de la carte mère
4. Installation de la carte mère
5. Installation de l'alimentation
6. Installation du disque dur
7. Installation du disque dur
8. Installation du lecteur optique
9. Retrait de la baie 5.25"
10. Réglage de la cage pour disque dur
11. Réglage de la cage pour disque dur
12. Installation du ventilateur frontal
13. Installation des ventilateurs supérieur et arrière
14. Installation du radiateur frontal (240/280mm)
15. Installation du radiateur frontal (360mm)
16. Installation du radiateur supérieur
17. Installation du radiateur arrière
18. Installation du LED frontal
19. Enlever le plateau de séparation
20. **Installation du contrôleur de ventilateurs**

Italian (IT)

1. Contenuto della confezione
2. Compatibilità
3. Installazione scheda madre
4. Installazione scheda madre
5. Installazione alimentatore
6. Installazione Hard Drive
7. Installazione Hard Drive
8. Installazione Drive Ottico
9. Rimozione Bay 5.25"
10. Regolazione cestello per Hard Drive
11. Regolazione cestello per Hard Drive
12. Installazione ventola frontale
13. Installazione ventola Superiore ed Posteriore
14. Installazione Radiatore Frontale (240/280mm)
15. Installazione Radiatore Frontale (360mm)
16. Installazione Radiatore Superiore
17. Installazione Radiatore Posteriore
18. Installazione LED Frontale
19. Rimozione pannello di separazione
20. INSTALLAZIONE DEL CONTROLLER DELLA VENTOLA

Polish (PL)

1. Zawartość opakowania
2. Zgodność
3. Montaż płyty głównej
4. Montaż płyty głównej
5. Montaż zasilacza
6. Montaż dysku twardego
7. Montaż dysku twardego
8. Montaż napędu optycznego
9. Wyjmowalna zatoka 5,25"
10. Regulacja zatoki dysku HDD
11. Regulacja zatoki dysku HDD
12. Montaż wentylatora z przodu
13. Montaż górnego i tylnego wentylatora
14. Montaż chłodnicy z przodu (240/280mm)
15. Montaż chłodnicy z przodu (360mm)
16. Montaż chłodnicy z góry
17. Montaż chłodnicy z tyłu
18. Montaż LED z przodu
19. Usunąć płytkę działową
20. montaż sterownika wentylatora

Russian (RU)

1. Содержание комплекта
2. Совместимость
3. Установка материнской платы
4. Установка материнской платы
5. Установка блока питания
6. Установка жесткого диска
7. Установка жесткого диска
8. Установка оптического привода
9. Демонтаж 5.25" отсека
10. Регулировка положения корзины HDD
11. Регулировка положения корзины HDD
12. Установка переднего вентилятора
13. Установка верхнего и заднего вентиляторов
14. Монтаж радиатора на передней панели (240/280mm)
15. Монтаж радиатора на передней панели (360mm)
16. Монтаж радиатора на верхней панели
17. Монтаж радиатора на задней панели
18. Монтаж LED на передней панели
19. Демонтаж перегородки
20. УСТАНОВКА КОНТРОЛЛЕРА ВЕНТИЛЯТОРА

Japanese (JA)

1. パッケージ内容
2. パーツ互換性
3. マザーボードの取り付け
4. マザーボードの取り付け
5. 電源ユニットの取り付け
6. ストレージデバイスの取り付け
7. ストレージデバイスの取り付け
8. 光学ドライブの取り付け
9. 5インチベイの取り外し
10. HDDケージの位置調整
11. HDDケージの位置調整
12. フロントファンの取り付け
13. トップとリアのファンの取り付け
14. 水冷ラジエータの取り付け(フロント)(240/280mm)
15. 水冷ラジエータの取り付け(フロント)(360mm)
16. 水冷ラジエータの取り付け(トップ)
17. 水冷ラジエータの取り付け(リア)
18. LEDの取り付け(フロント)
19. ドライブケージの取り外し
20. ファンコントローラの取り付け

Chinese (CHT)

1. 包裝內含物品明細
2. 相容性
3. 主機板安裝指南
4. 主機板安裝指南
5. 電源供應器安裝指南
6. 硬碟安裝指南
7. 2.5吋硬碟、SSD安裝指南
8. 光碟機安裝指南
9. 5.25吋支架移除方式
10. 硬碟架調整方式
11. 硬碟架調整方式
12. 前方風扇安裝指南
13. 上方、後方風扇安裝指南
14. 前方 (240/280mm) 水冷排安裝指南
15. 前方 (360mm) 水冷排安裝指南
16. 上方水冷排安裝指南
17. 後方水冷排安裝指南
18. 前方LED燈安裝指南
19. 拆卸中隔板指南
20. 風扇轉速控制器安裝指南

Chinese (CHS)

1. 包裝內含物品清單
2. 兼容性
3. 主板安裝指南
4. 主板安裝指南
5. 電源安裝指南
6. 硬盘安裝指南
7. 2.5吋硬盘、SSD安裝指南
8. 光驱安裝指南
9. 5.25吋光驱支架移除方式
10. 硬盘架調整方式
11. 硬盘架調整方式
12. 前方風扇安裝指南
13. 上方、後方風扇安裝指南
14. 前方 (240/280mm) 水冷排安裝指南
15. 前方 (360mm) 水冷排安裝指南
16. 上方水冷排安裝指南
17. 後方水冷排安裝指南
18. 前方LED燈安裝指南
19. 拆卸中隔板指南
20. 風扇轉速控制器安裝指南

Bulgaria (BG)

1. Съдържание
2. съвместимост
3. монтаж на дънна платка
4. монтаж на дънна платка
5. монтаж на захранващ блок
6. монтаж на твърд диск
7. монтаж на твърд диск
8. монтаж на оптично устройство
9. 5.25" отделение за оптично устройство
10. регулиране на отделението за твърд диск
11. регулиране на отделението за твърд диск
12. монтаж на преден вентилатор
13. монтаж на горен и заден вентилатор
14. монтаж на преден радиатор (240/280mm)
15. монтаж на преден радиатор (360mm)
16. монтаж на горен радиатор
17. монтаж на заден радиатор
18. монтаж на преден LED
19. Премахване на разделителната пластина
20. Монтиране на панела за управление на вентилатора

Czech (CS)

1. balení obsahuje
2. kompatibilita
3. instalace základní desky
4. instalace základní desky
5. instalace napájecího zdroje
6. instalace pevného disku
7. instalace pevného disku
8. instalace optické mechaniky
9. Vyjmutelná 5.25" pozice
10. Přizpůsobitelný držák na HDD
11. Přizpůsobitelný držák na HDD
12. instalace předního větráku
13. instalace vrchního a zadního větráku
14. instalace vodního chlazení zepředu (240/280mm)
15. instalace vodního chlazení zepředu (360mm)
16. instalace vodního chlazení zvrchu
17. instalace vodního chlazení zezadu
18. instalace LED zepředu
19. Odstranitelná rozdělovací deska
20. instalace ovladače ventilátoru

Greek (EL)

1. Περιεχόμενα συσκευασίας
2. Συμβατότητα
3. Εγκατάσταση μητρικής πλακέτας
4. Εγκατάσταση μητρικής πλακέτας
5. Εγκατάσταση τροφοδοτικού
6. Εγκατάσταση σκληρού δίσκου
7. Εγκατάσταση σκληρού δίσκου
8. Εγκατάσταση οπτικού δίσκου
9. Αφαίρεση 5.25" φατινίου
10. Προσαρμογή cage σκληρών δίσκων
11. Προσαρμογή cage σκληρών δίσκων
12. Εγκατάσταση μπροστινού ανεμιστήρα
13. Εγκατάσταση άνω και πίσω ανεμιστήρα
14. Εγκατάσταση μπροστινού ψυγείου (240/280mm)
15. Εγκατάσταση μπροστινού ψυγείου (360mm)
16. Εγκατάσταση επάνω ψυγείου
17. Εγκατάσταση πίσω ψυγείου
18. Εγκατάσταση μπροστινού LED
19. Αφαιρέστε το partition plate
20. ΕΓΚΑΤΑΣΤΑΣΗ FAN CONTROLLER

Hungarian (HU)

1. A csomag tartalma
2. kompatibilitás
3. alaplapp beszerelés
4. alaplapp beszerelés
5. tápegység beszerelés
6. merevlemez beszerelés
7. merevlemez beszerelés
8. optikai meghajtó beszerelés
9. 5.25" rekesz eltávolítása
10. merevlemez keret állítása
11. merevlemez keret állítása
12. elülső ventilátor állítása
13. elülső és hátsó ventilátor beszerelése
14. elülső radiátor beszerelés (240/280mm)
15. elülső radiátor beszerelés (360mm)
16. felső radiátor beszerelés
17. hátsó radiátor beszerelés
18. elülső LED beszerelés
19. Távolítsa el az elválasztó lapot
20. Ventilátor vezérlő beszerelése

Dutch (NL)

1. Verpakkingsinhoud
2. Compatibiliteit
3. Moederbord installatie
4. Moederbord installatie
5. Voeding installatie
6. Harde schijf installatie
7. Harde schijf installatie
8. Optische drive installatie
9. 5.25" verwijderen
10. Aanpassen harde schijf kooi
11. Aanpassen harde schijf kooi
12. Fan installatie voorkant
13. Faninstallatie bovenkant & achterkant
14. Radiator installatie voorkant (240/280mm)
15. Radiator installatie voorkant (360mm)
16. Radiator installatie bovenkant
17. Radiator installatie achterkant
18. Verwijder scheidingsplaat
19. Verander voorpaneel
20. Fan Controller installatie

Portugal (PT)

1. Conteúdo da embalagem
2. Compatibilidade
3. Instalação da motherboard
4. Instalação da motherboard
5. Instalação da fonte de alimentação
6. Instalação do disco rígido
7. Instalação do disco rígido
8. Instalação da drive óptica
9. Remoção da baía de 5.25"
10. Ajuste da cage dos discos rígidos
11. Ajuste da cage dos discos rígidos
12. Instalação da ventoinha frontal
13. Instalação da ventoinha no topo e traseira
14. Instalação do radiador na frontal (240/280mm)
15. Instalação do radiador na frontal (360mm)
16. Instalação do radiador no topo
17. Instalação do radiador na traseira
18. Remoção do painel de partição
19. Mudança do painel frontal
20. Instalação do controlador de ventoinhas

Serbian (SR)

1. Sadržaj pakovanja
2. kompatibilnost
3. instalacija matične ploče
4. instalacija matične ploče
5. instalacija napajanja
6. instalacija hard diska
7. instalacija hard diska
8. instalacija optičkog uređaja
9. uklanjanje 5.25" ležišta
10. podešavanje kaveza za hard disk
11. podešavanje kaveza za hard disk
12. instalacija prednjeg ventilatora
13. instalacija gornjeg i zadnjeg ventilatora
14. instalacija prednjeg radijatora (240/280mm)
15. instalacija prednjeg radijatora (360mm)
16. instalacija gornjeg radijatora
17. instalacija zadnjeg radijatora
18. instalacija prednjeg LED
19. Ukloniti pregradni panel
20. Ugradnja kontrolera za ventilatore

Turkish (TR)

1. Paket İçeriği
2. Uyumluluk
3. Anakart Kurulumu
4. Anakart Kurulumu
5. Güç Kaynağı Kurulumu
6. Sabit Disk Kurulumu
7. Sabit Disk Kurulumu
8. Optik Sürücü Kurulumu
9. 5.25" Sürücü Kapağının Çıkarılması
10. Sabit Disk Kızak Ayarlaması
11. Sabit Disk Kızak Ayarlaması
12. Ön Fanın Takılması
13. Üst ve Arka Fanın Takılması
14. Ön Radyatör Kurulumu (240/280mm)
15. Ön Radyatör Kurulumu (360mm)
16. Üst Radyatör Kurulumu
17. Arka Radyatör Kurulumu
18. Ön LED Kurulumu
19. Bölme plakasını çıkarın
20. FAN KONTROLÇÜ KURULUMU

Korean (kR)

1. 구성품 내용
2. 호환성
3. 메인보드 설치
4. 메인보드 설치
5. 파워 서플라이 설치
6. HDD / SDD 설치
7. HDD / SDD 설치
8. ODD 설치
9. 5.25" Bay 제거
10. HDD Cage 위치 변경
11. HDD Cage 위치 변경
12. 전면 팬 설치
13. 상단 / 후면 팬 설치
14. 전면 라디에이터 설치
(240/280mm)
15. 전면 라디에이터 설치
(360mm)
16. 상단 라디에이터 설치
17. 후면 라디에이터 설치
18. 전면 LED 설치
19. 칸막이 제거
20. 팬 컨트롤러 설치

Indonesia (ID)

1. Isi paket
2. Kompatibilitas
3. Instalasi motherboard
4. Instalasi motherboard
5. Instalasi power supply
6. instalasi hard disk
7. instalasi hard disk
8. instalasi perangkat optikal
9. Melepaskan perangkat 5,25"
10. Pengaturan kandang hard disk
11. Pengaturan kandang hard disk
12. Instalasi kipas depan
13. Instalasi kipas atas dan belakang
14. instalasi radiator depan
(240/280mm)
15. instalasi radiator depan
(360mm)
16. instalasi radiator atas
17. instalasi radiator belakang
18. Instalasi LED Depan
19. Melepaskan pelat partisi
20. instalasi pengontrol kipas

Arabic (AR)

- 1 محتوى الطرد
- 2 التوافق
- 3 تركيب اللوحة الأم
- 4 تركيب اللوحة الأم
- 5 تركيب التيار الكهربائي
- 6 تركيب القرص الصلب
- 7 تركيب القرص الصلب
- 8 تركيب محرك الأقراص الضوئية
- 9 إزالة خليج " 5.25
- 10 القرص الصلب قفص تعديل
- 11 القرص الصلب قفص تعديل
- 12 تركيب مروحة أمامية
- 13 تركيب مروحة علوية وخلفية
- 14 تركيب الجبهة المشعاع
(240/280mm)
- 15 تركيب الجبهة المشعاع
(360mm)
- 16 تركيب الأعلى المشعاع
- 17 تركيب الخلفي المشعاع
- 18 LED تركيب الحبة
- 19 قم بنزع لوح الحاجز السفلي
- 20 تركيب متحكم المروحة



Make It Yours.

Asia Pacific - Cooler Master Technology Inc.
8F., No. 788-1, Zhongzheng Rd., Zhonghe Dist.,
New Taipei City 23586, Taiwan (R.O.C.).
Tel: +886-2-2225-3517

China - Cooler Master China
Room 2062, Floor 6, No. 421, Weiqing Rd.,
Jinshan District, Shanghai City, China
Tel: +86-21-51872177

Europe - Cooler Master Europe B.V.
Lodewijkstraat 1b, 5652AC Eindhoven, The Netherlands
Tel: +31-(0)40-702-0900

North America - Cooler Master NA
4820 Schaefer Ave. Chino CA, 91710, USA
Tel: +1-888-624-5099



Product Page

www.coolermaster.com/qr/mastercase-mc600p



Technical Support

account.coolermaster.com

512000321-GP Ver 1.0: 2017/12 

The color and specification are subject to be changed without further notification.
Please visit our website for updated information: www.coolermaster.com

©2017 Cooler Master Technology Inc. All Rights Reserved. All trademarks are registered to their respective owners.