

# HIDDEN SIDE™

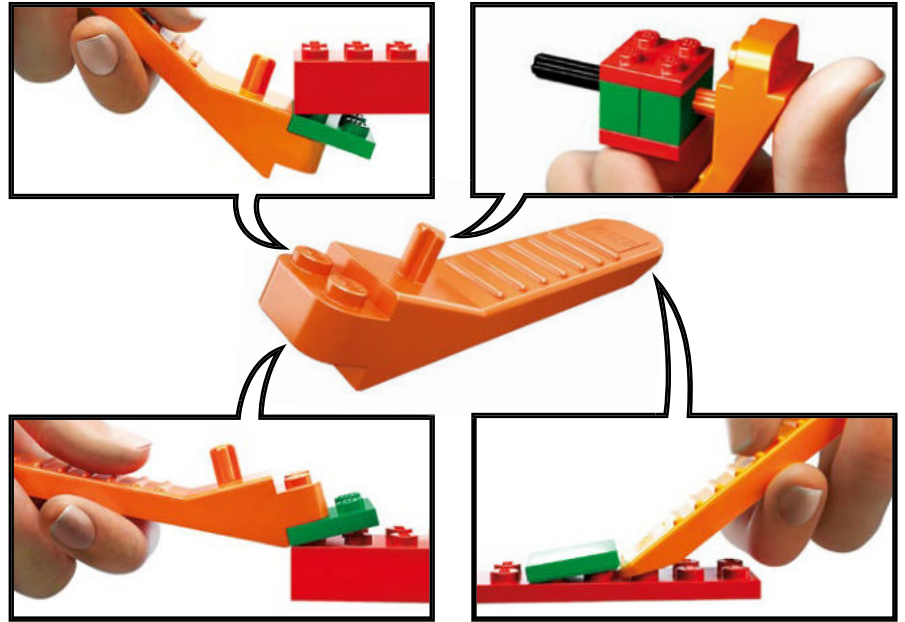

70432





[LEGO.com/brickseparator](https://LEGO.com/brickseparator)

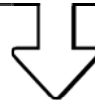
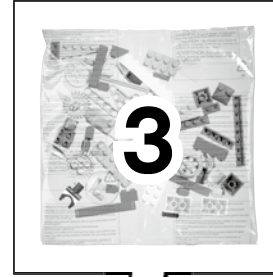
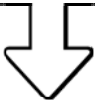
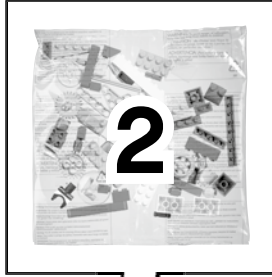
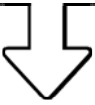

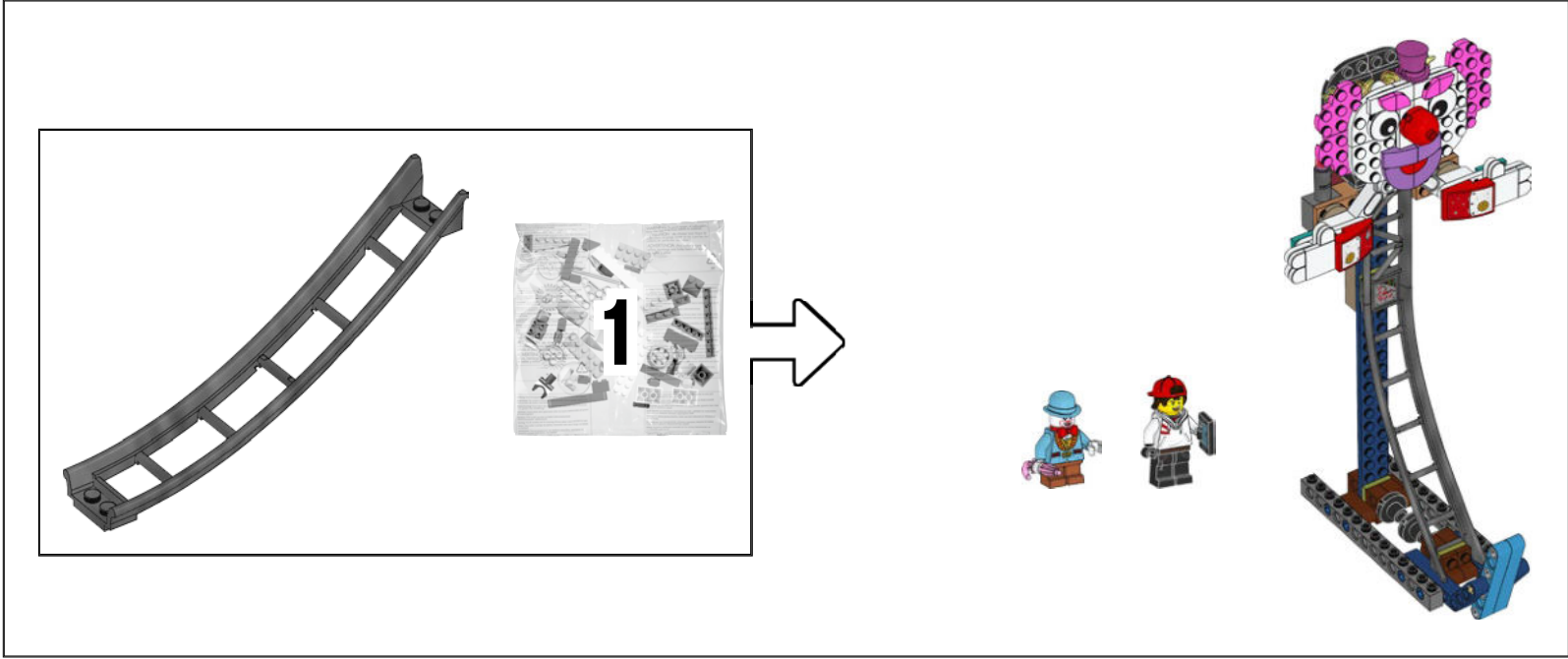



# HIDDEN SIDE™

## FREE INTERACTIVE APP

Kostenlose interaktive App  
 Appli interactive gratuite  
 App interattiva gratuita  
 App interactiva gratis  
 App interativa grátis  
 Ingyenes interaktív alkalmazás  
 Bezmaksas interaktiva lietojne  
 免费交互式应用程序



LEGO® Hidden Side™  
[LEGO.com/devicecheck](http://LEGO.com/devicecheck)

Check for compatibility  
 Kompatibilität prüfen  
 Vérifier la compatibilité  
 Controlla la compatibilità  
 Comprueba tu compatibilidad  
 Verificar a compatibilidade  
 Ellenőrizd a kompatibilitást  
 Pārbaudīt saderību  
 检查兼容性

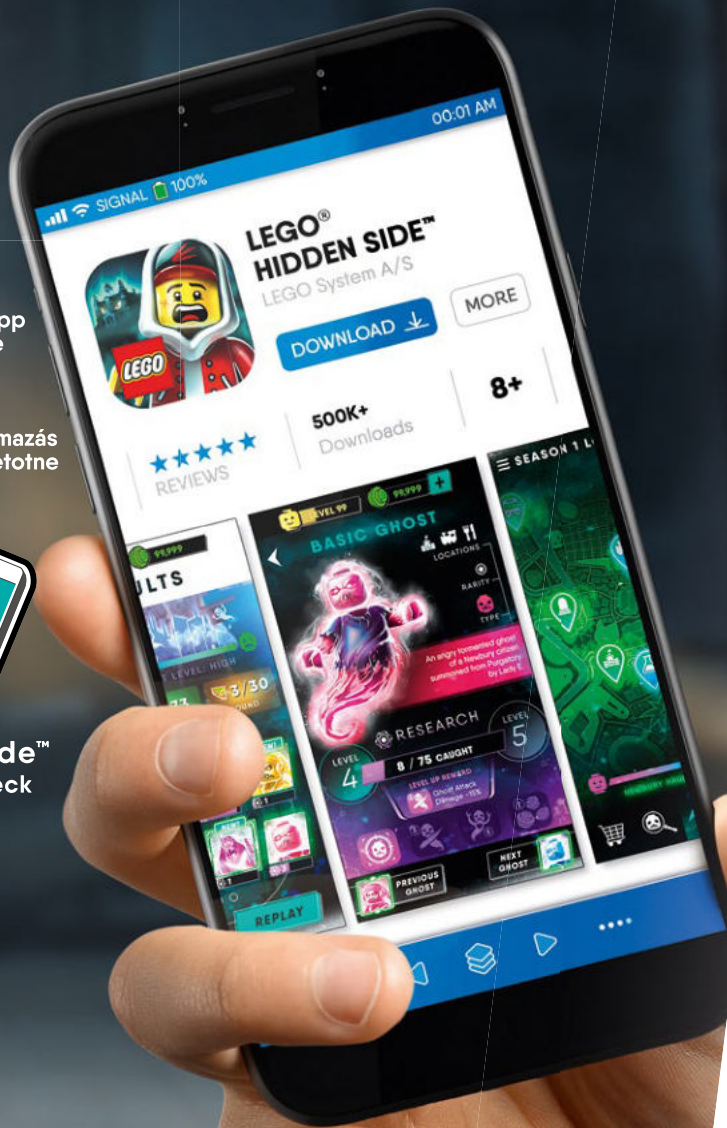

## Play in a well-lit area.

Spieler in einem gut beleuchteten Bereich.  
 Joue dans un endroit bien éclairé.  
 Posiziona il set in un'area ben illuminata.  
 Juega en un área bien iluminada.  
 Joga numa área bem iluminada.  
 Játssz jól megvilágított területen!  
 Rotājājies labi apgaismotā zonā.  
 请在光线充足的地方玩乐。



## Play on a clean, flat surface.

Spieler auf einer sauberen und ebenen Oberfläche.  
 Joue sur une surface propre et plane.  
 Posiziona il set su una superficie pulita e piana.  
 Juega sobre una superficie lisa y despejada.  
 Joga sobre uma superfície plana e limpa.  
 Játssz tiszta, sík felületen!  
 Rotājājies uz tīras, līdzenas virsmas.  
 请在干净平整的表面上玩乐。



## Avoid patterned and reflective surfaces.

Vermeide gemusterte und spiegelnde Oberflächen.  
 Évite les surfaces à motifs et réfléchissantes.  
 Evita superfici riflettenti, con disegni o motivi.  
 Evita las superficies decoradas con patrones y reflectantes.  
 Evita superficies refletoras e com motivos decorativos.  
 Kerüld a mintás és visszatükröződő felületeket!  
 Neizmanto virsmas ar rakstu vai atstarojošas virsmas.  
 避免使用带图案和可反光的表面。



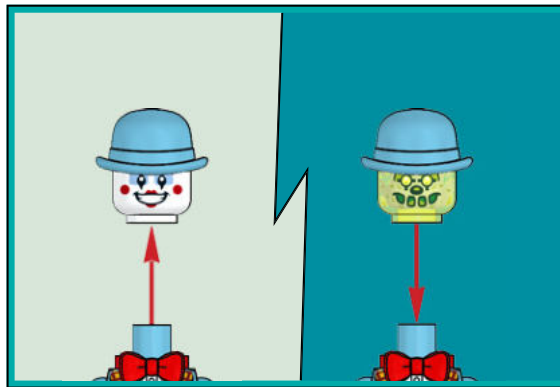
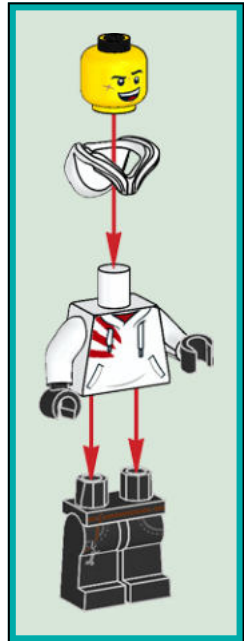

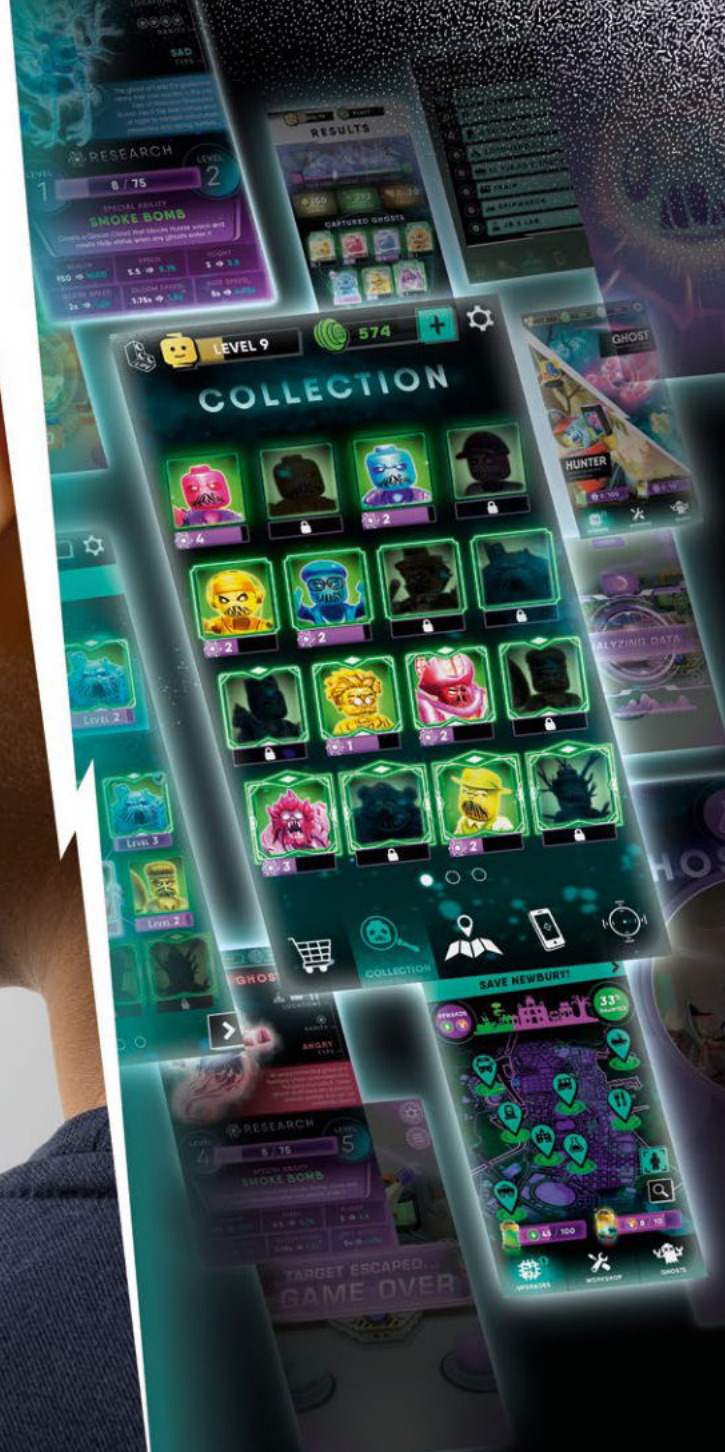

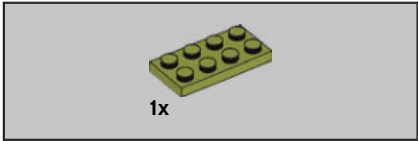
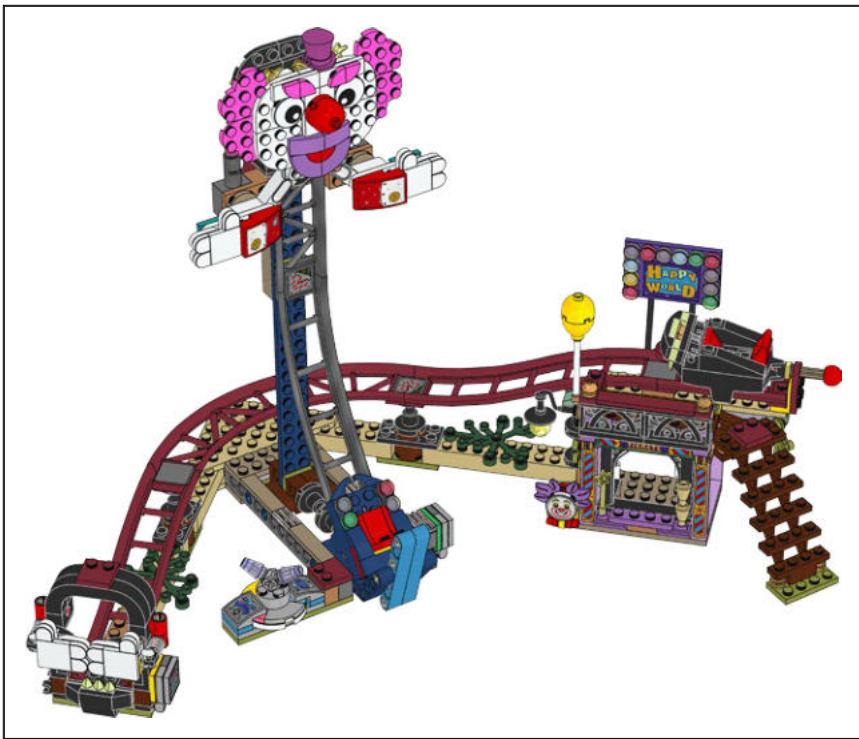

1

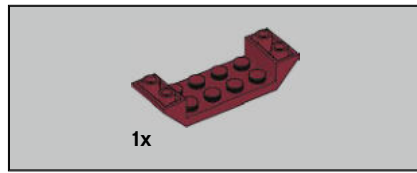
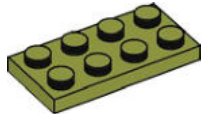

2

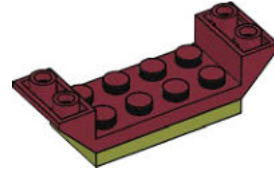

3

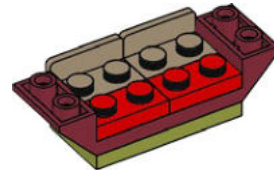



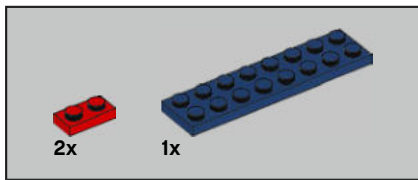

4

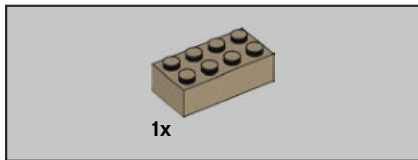
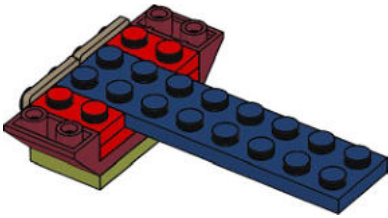

5

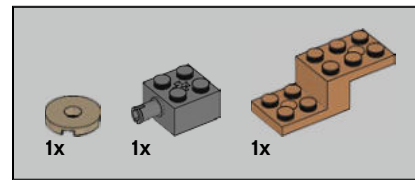
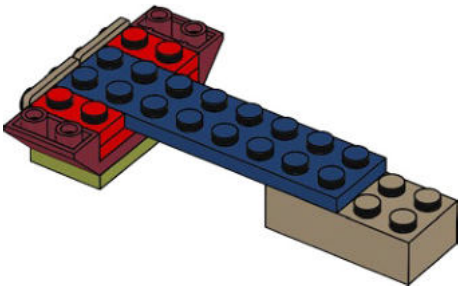

6

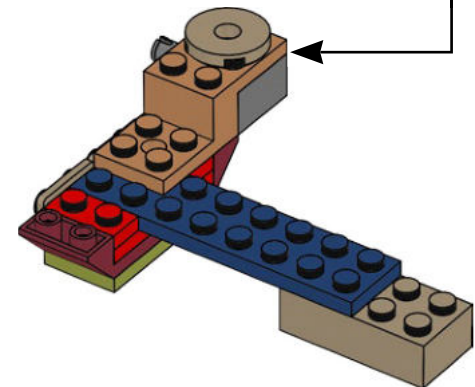
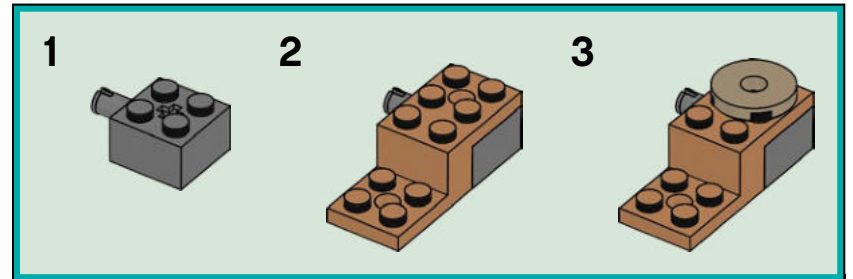

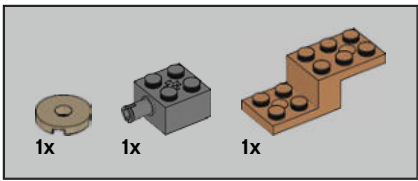

7

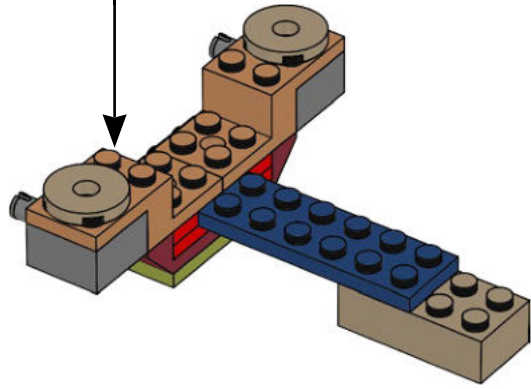
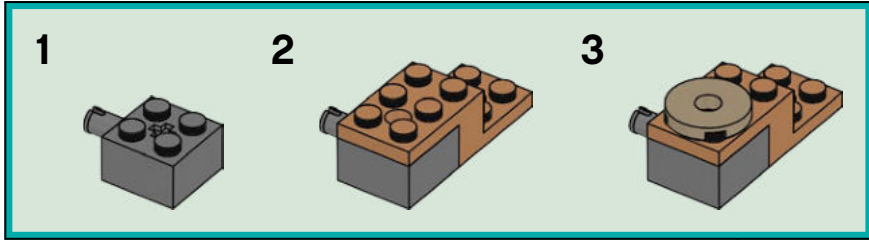

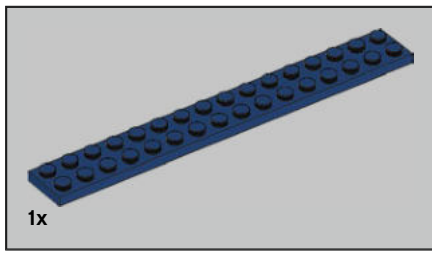

8

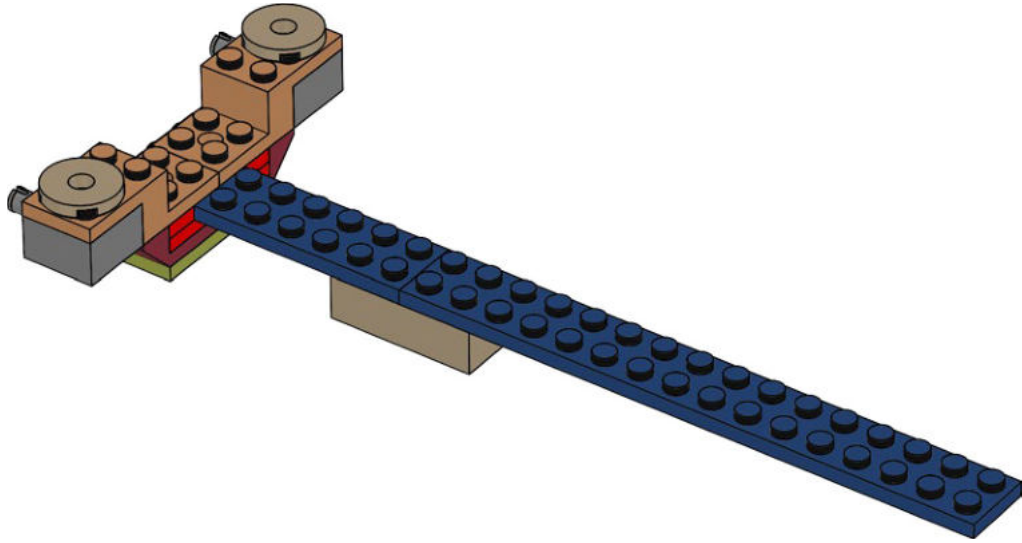

9

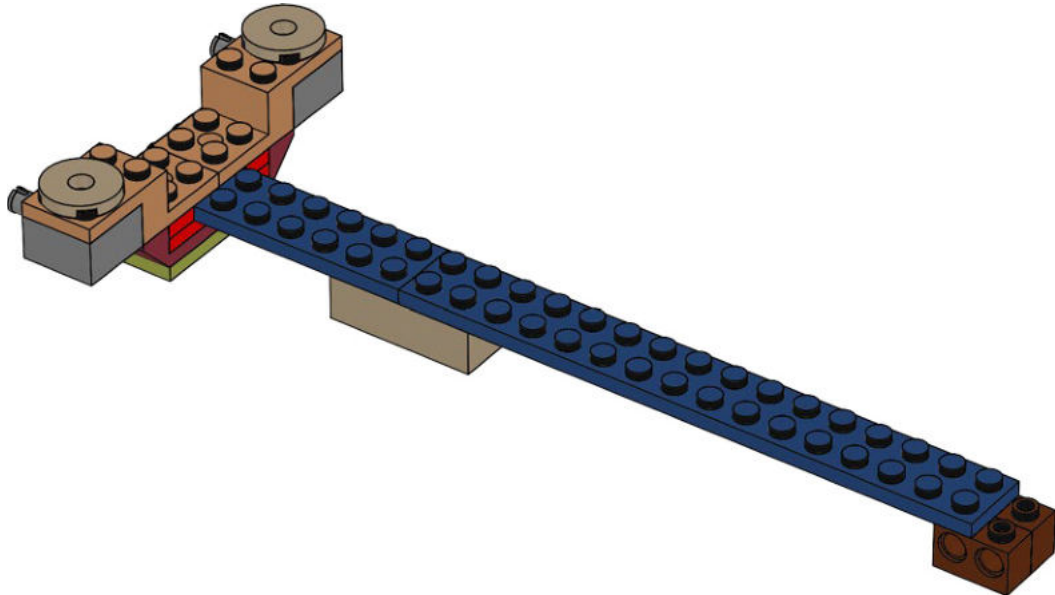



1x

10

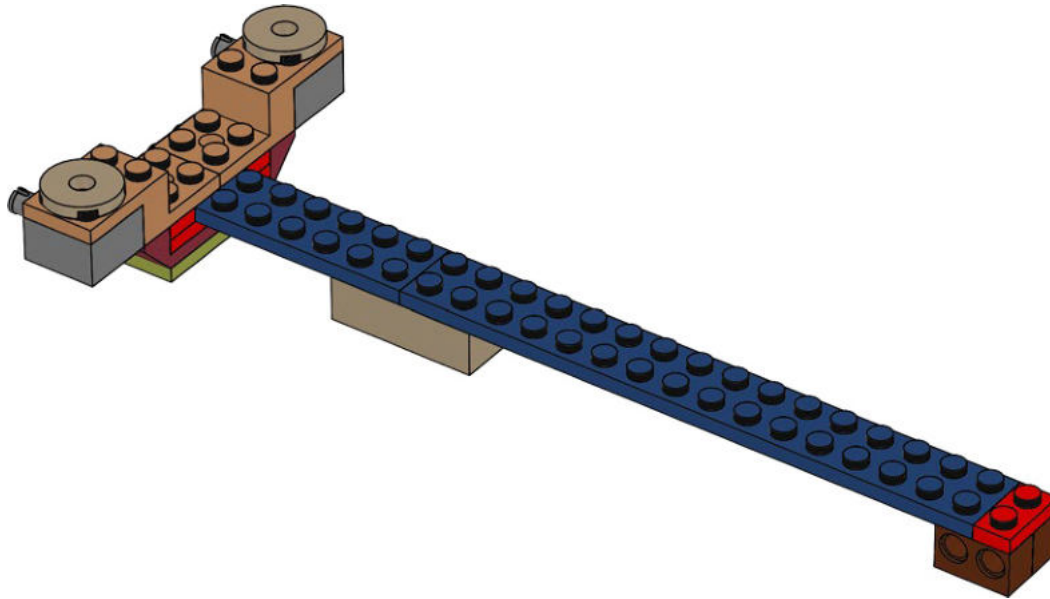



11

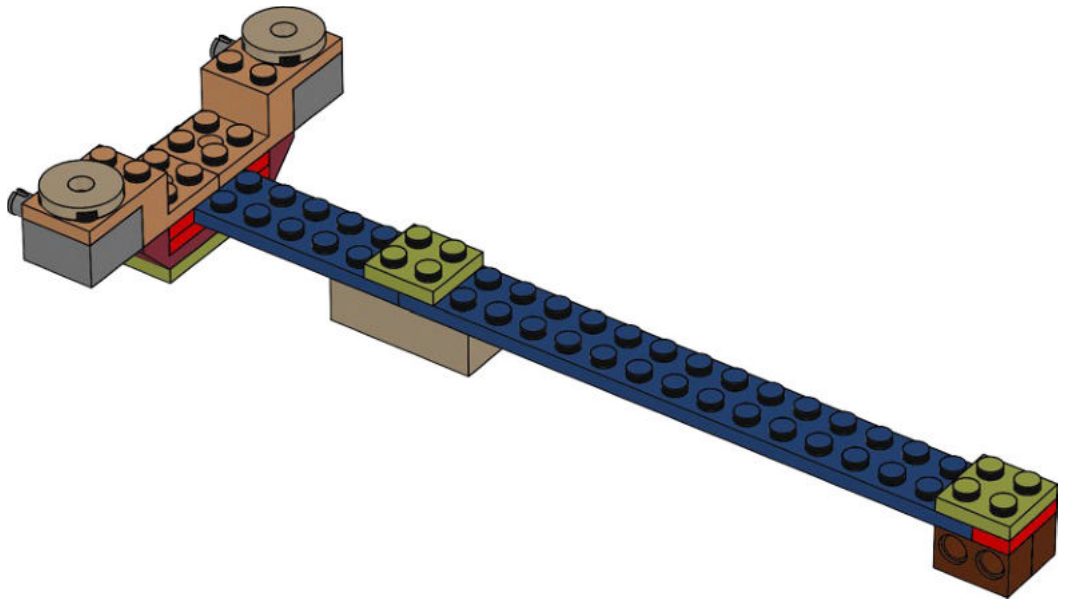

12

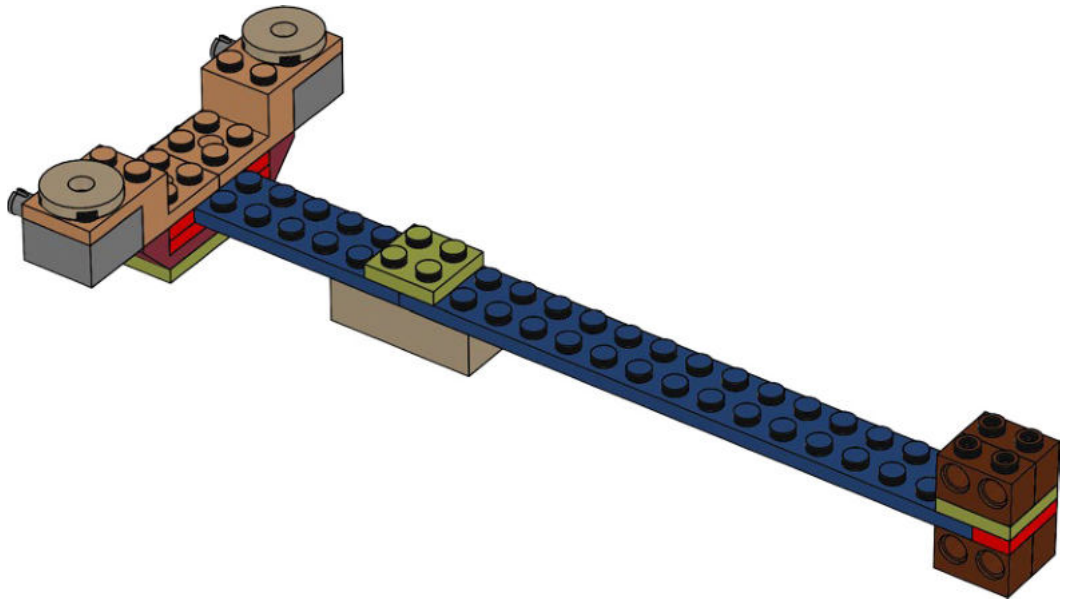



13

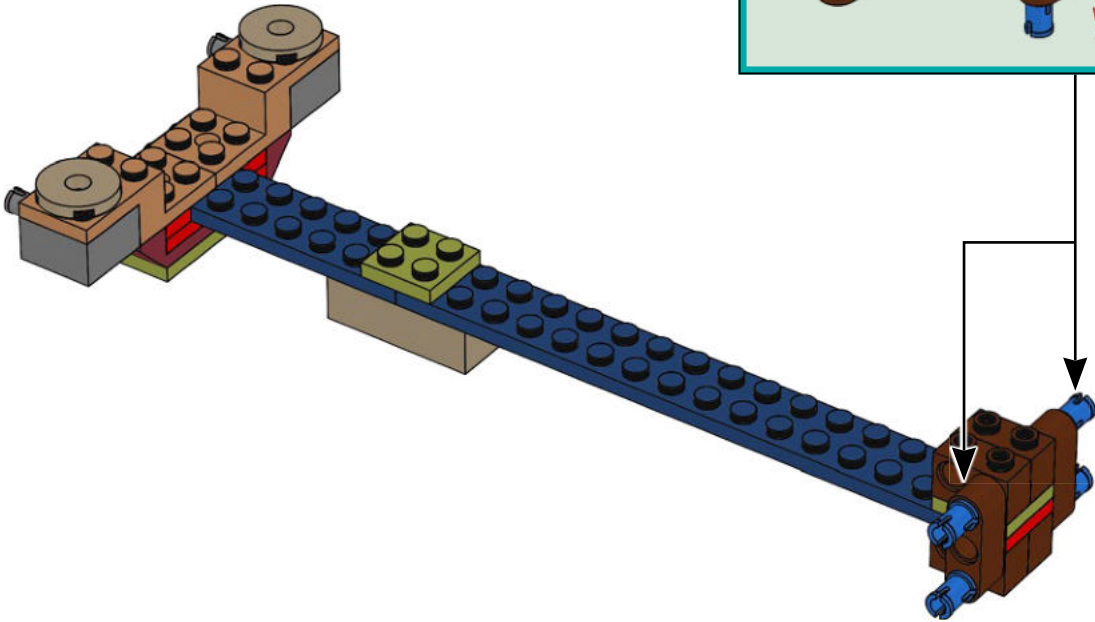

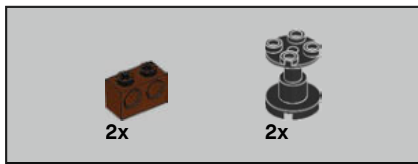

14

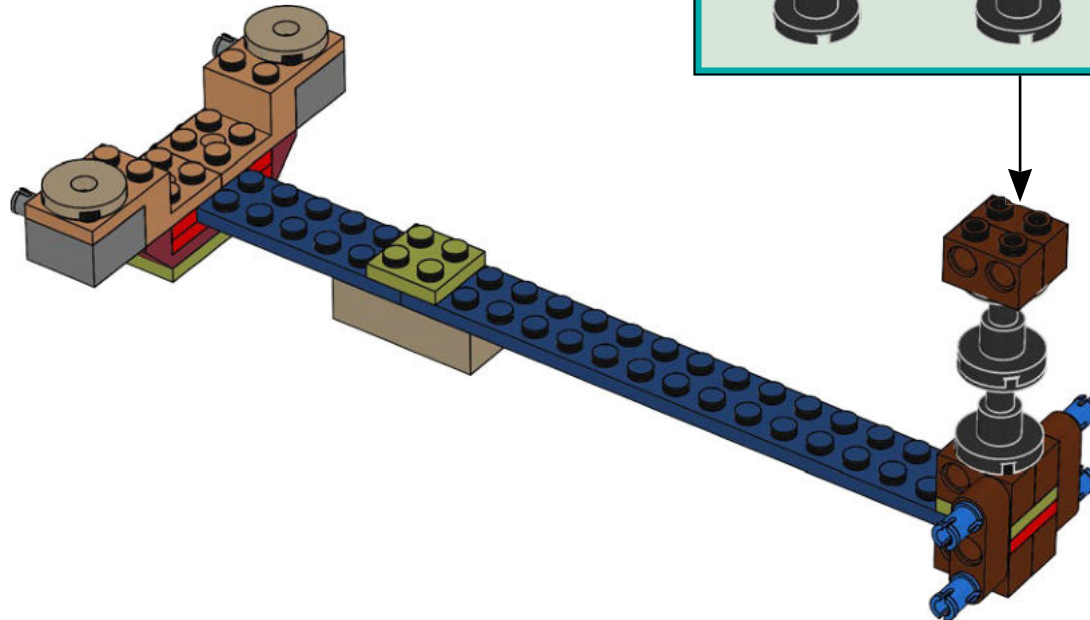
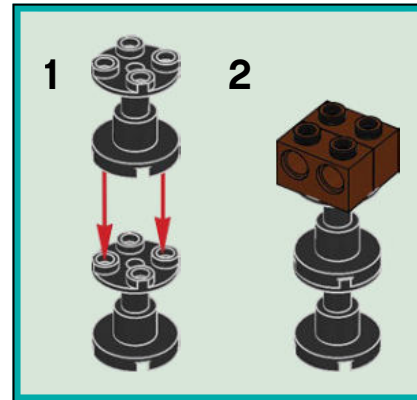

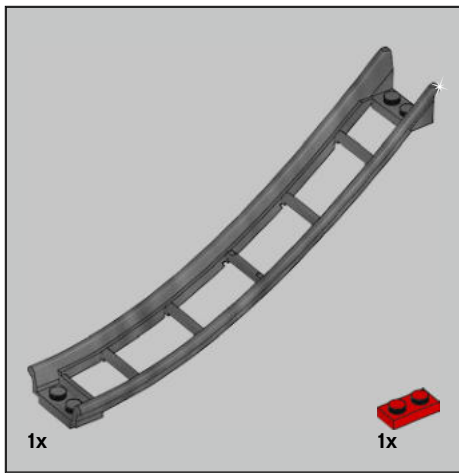

15

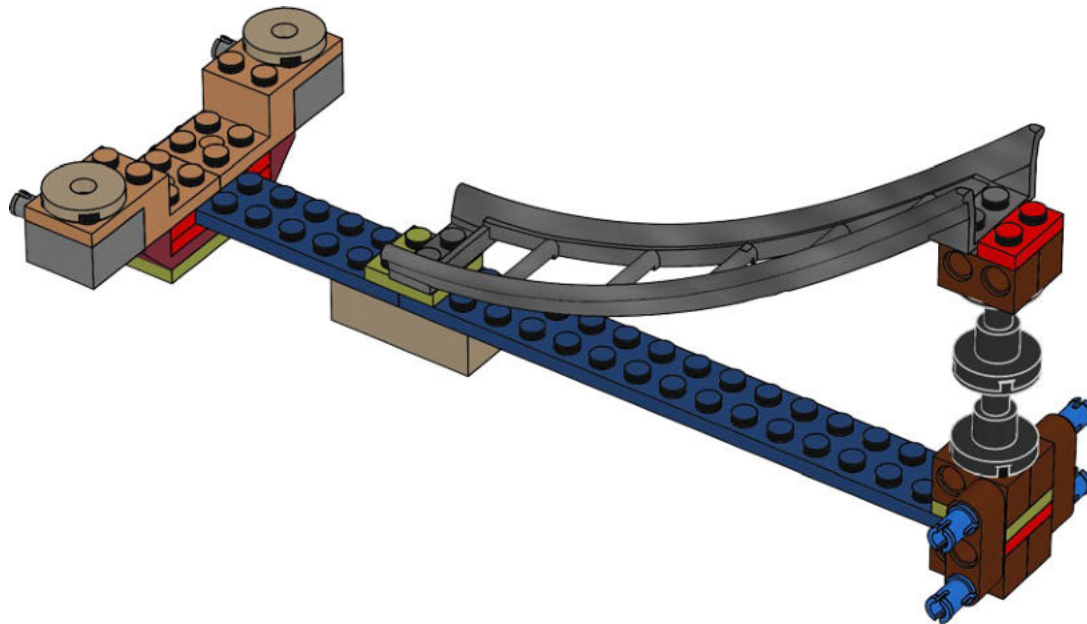



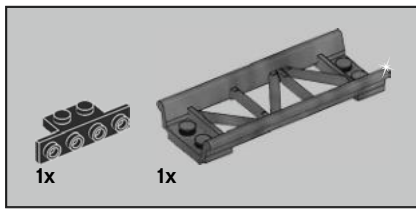

16

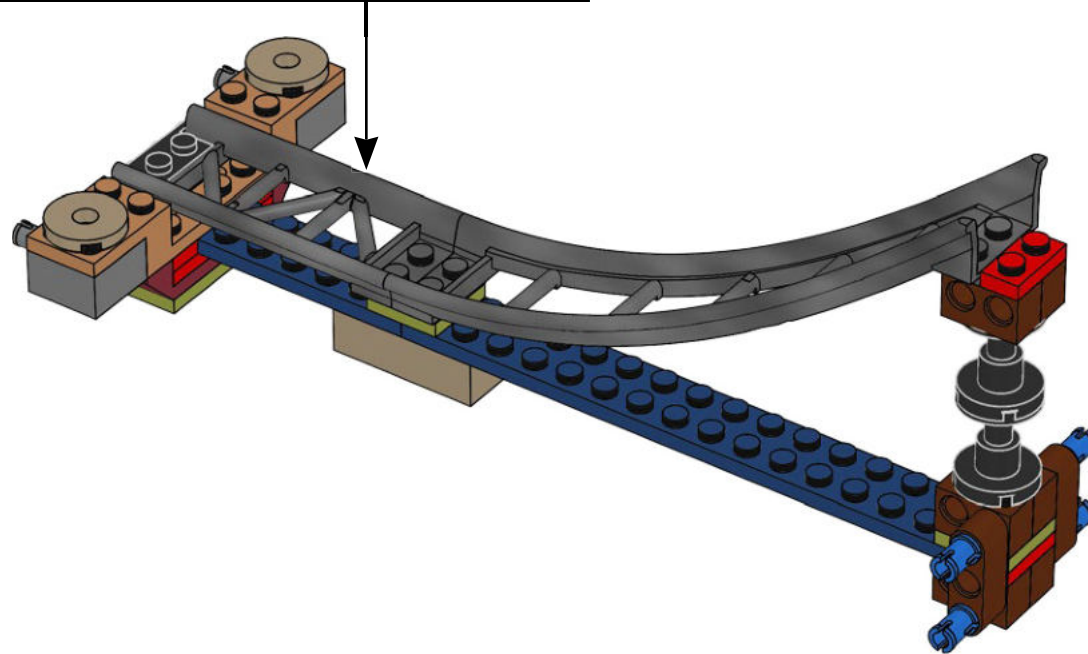
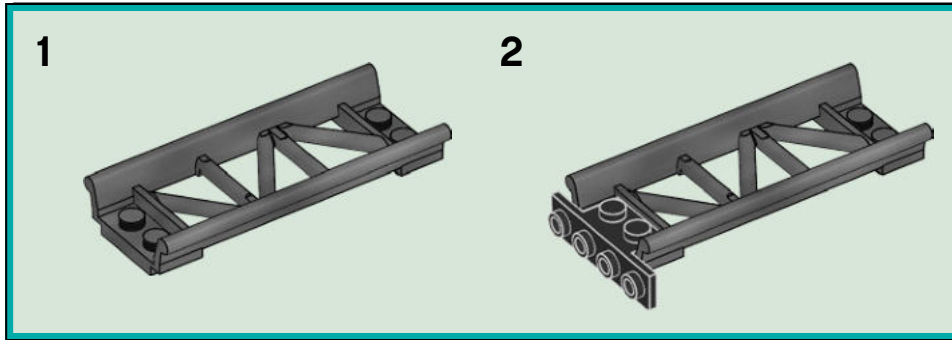

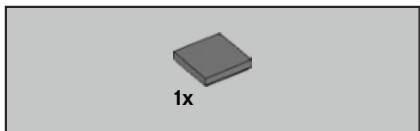

17

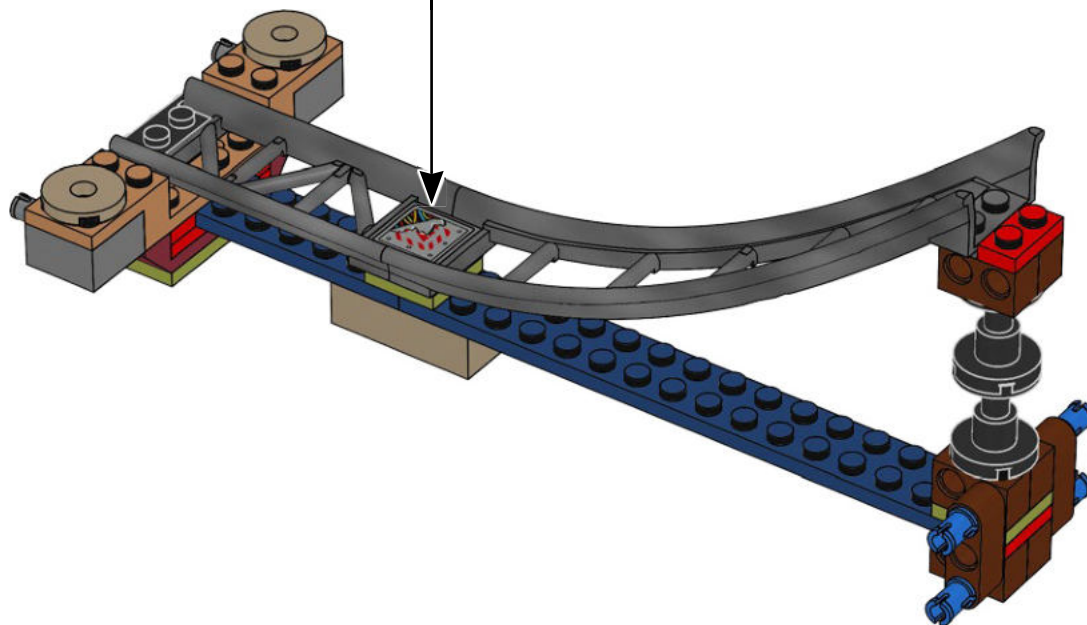
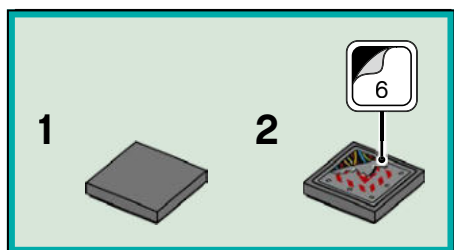



18

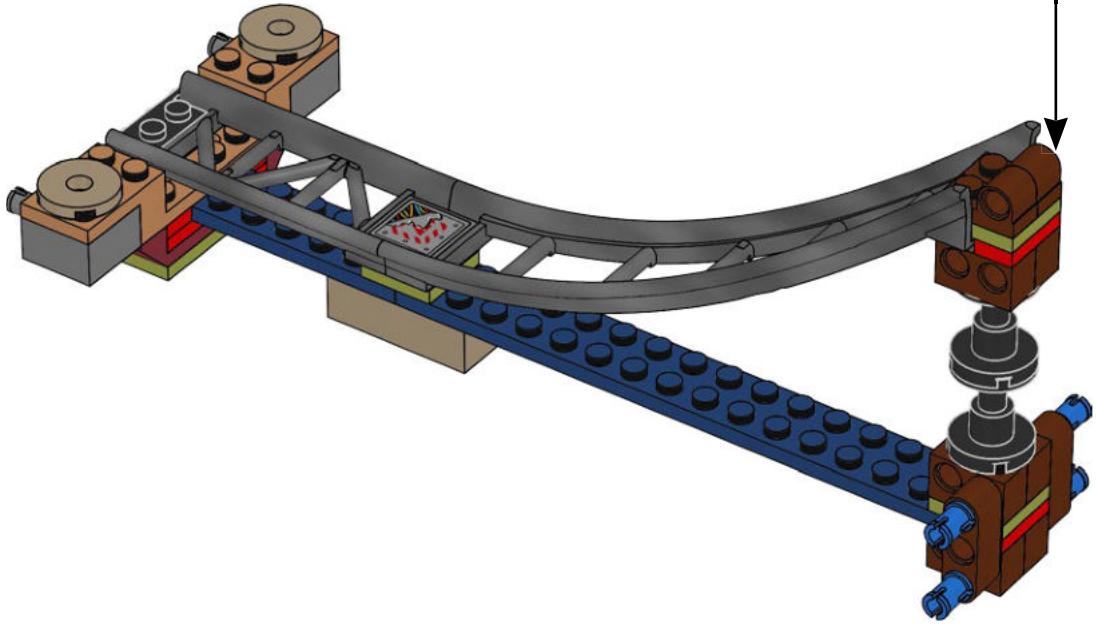
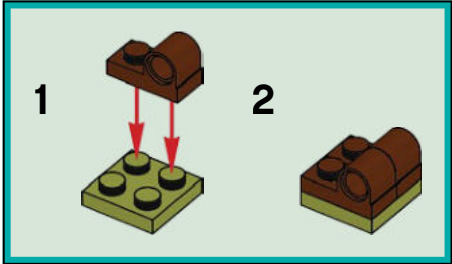

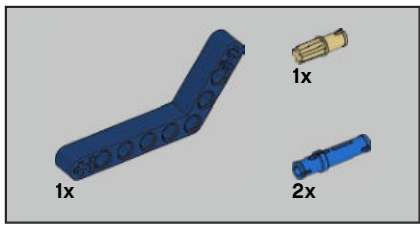

19

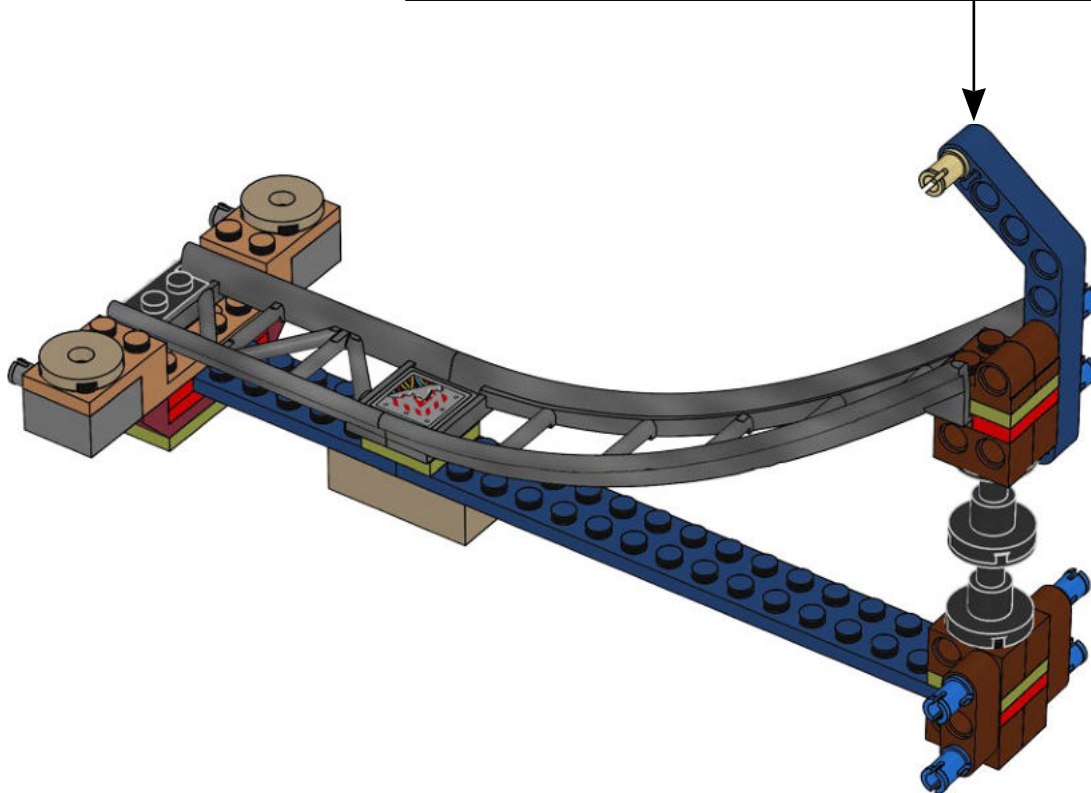
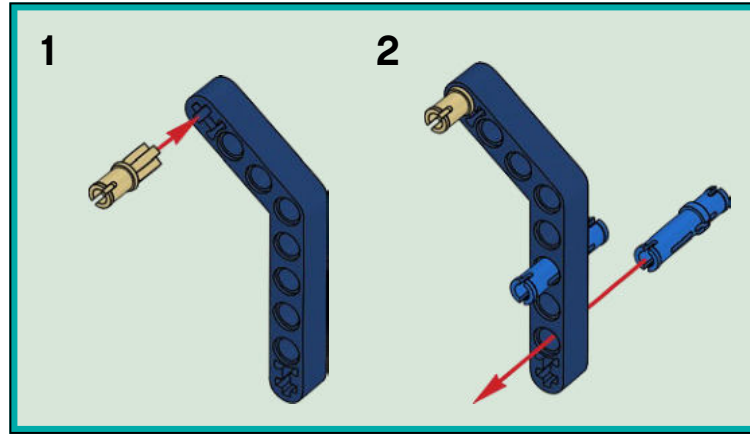

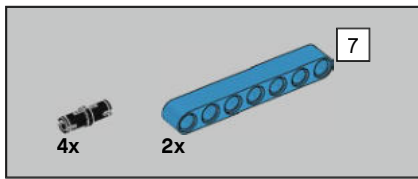

20

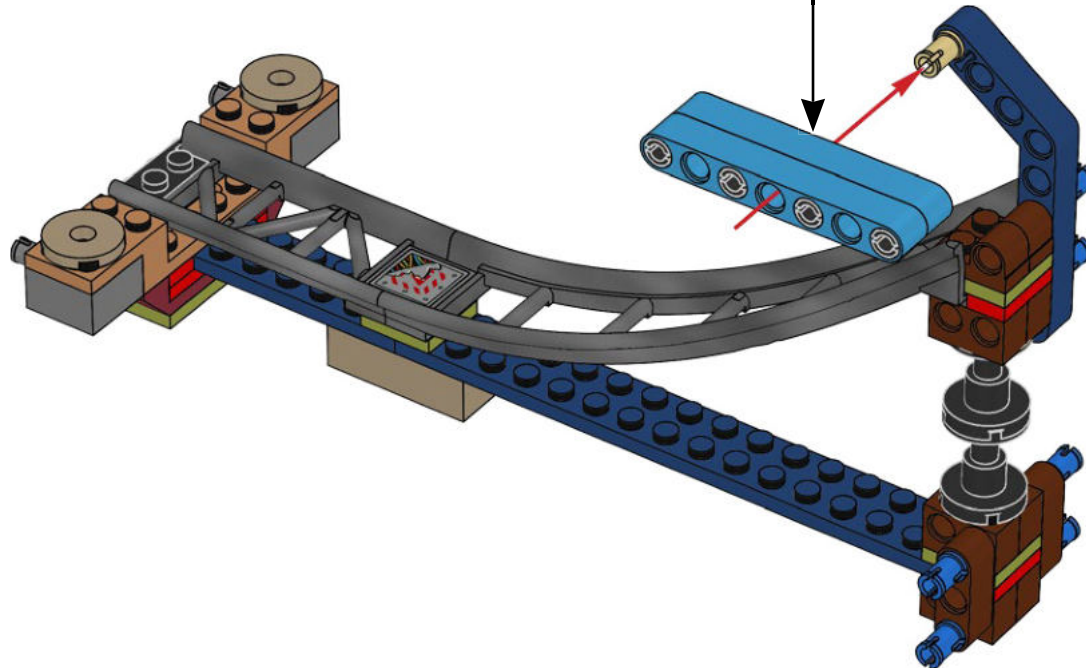
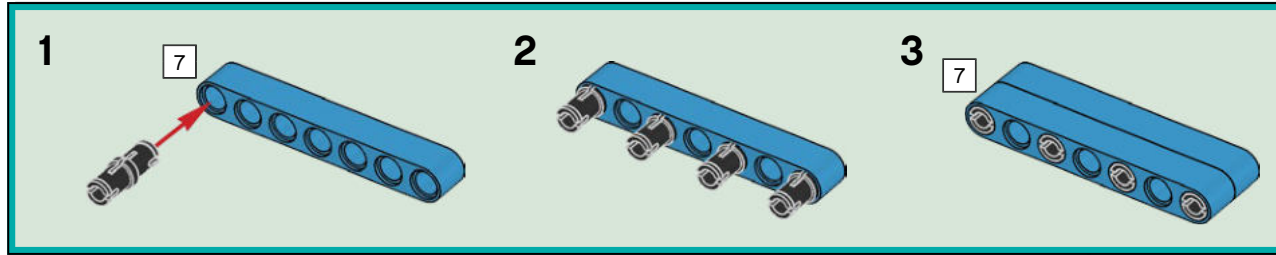

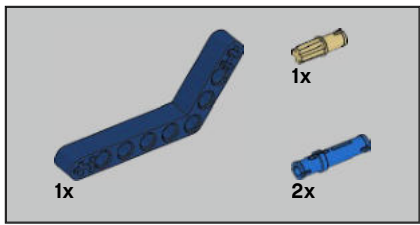

21

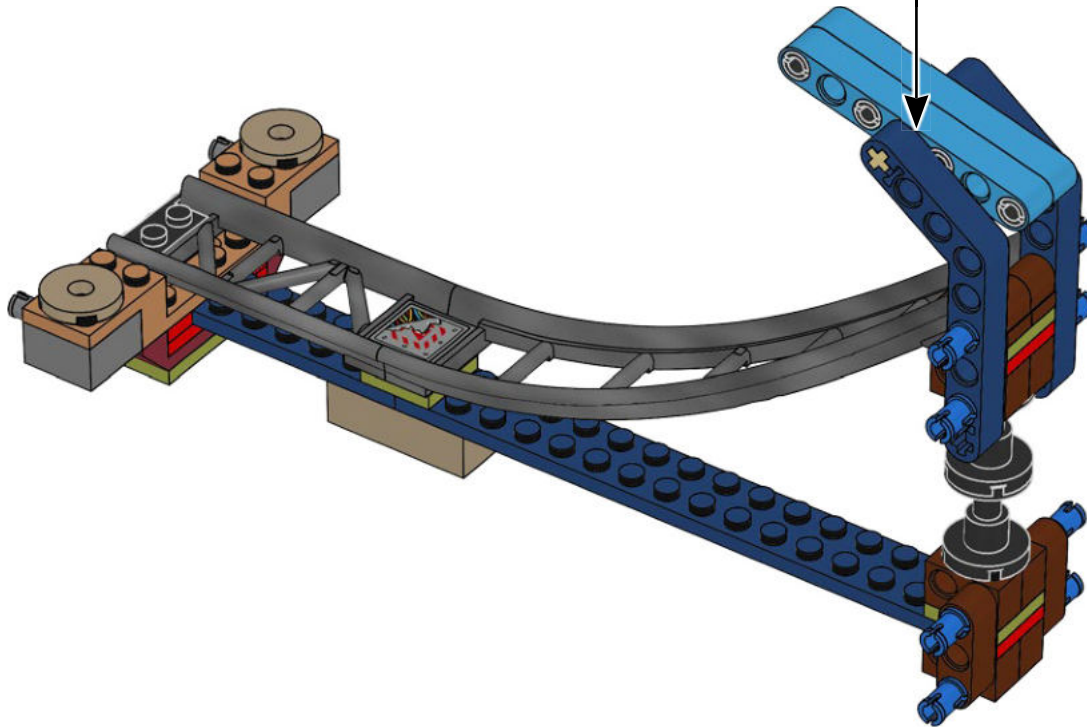
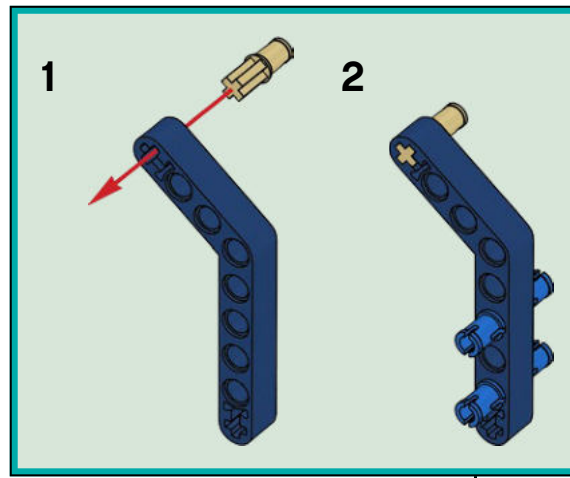

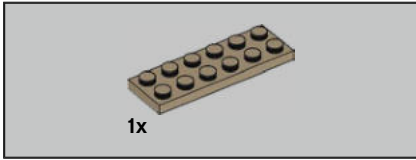
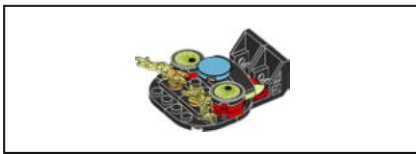

22

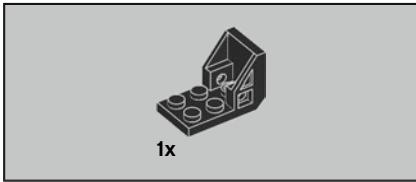

23

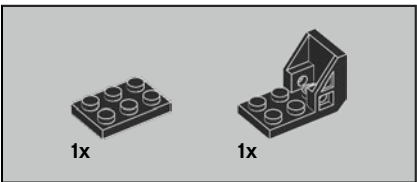
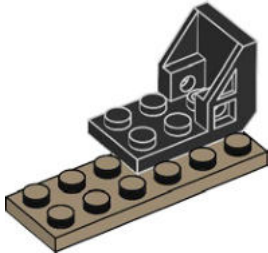

24

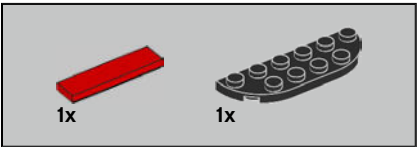
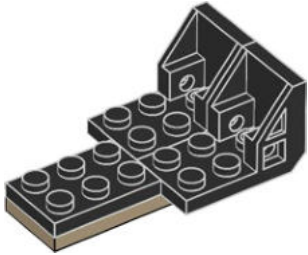

25

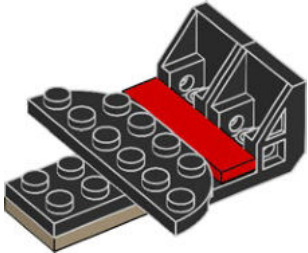

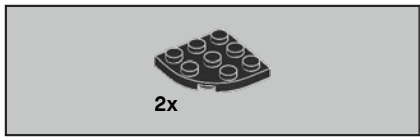

26

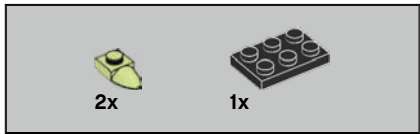
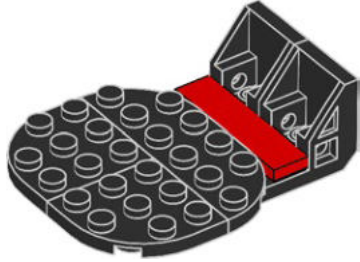

27

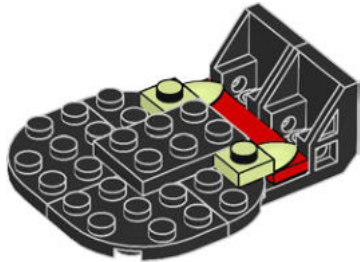

28

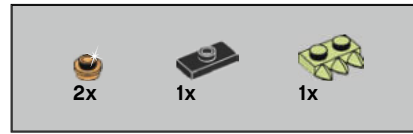
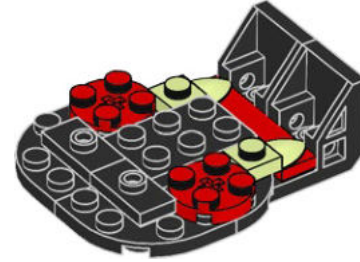

29

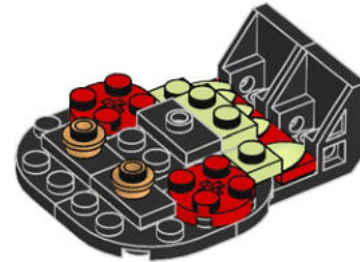





30

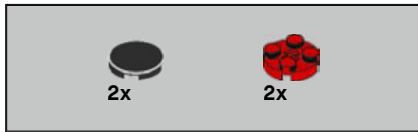
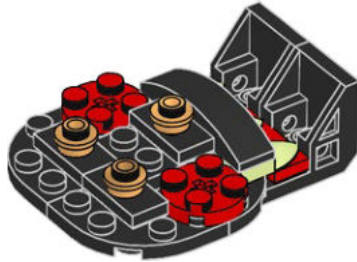

31

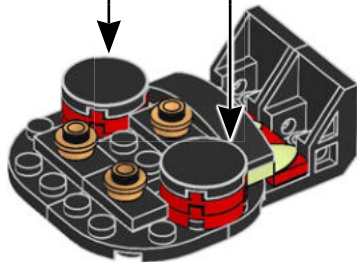
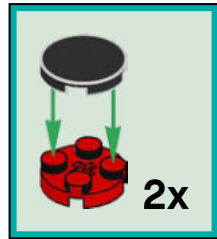

32

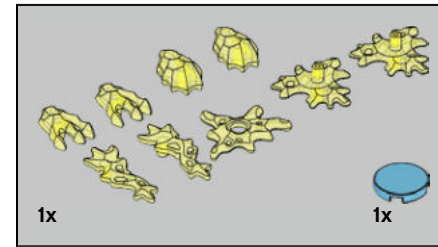
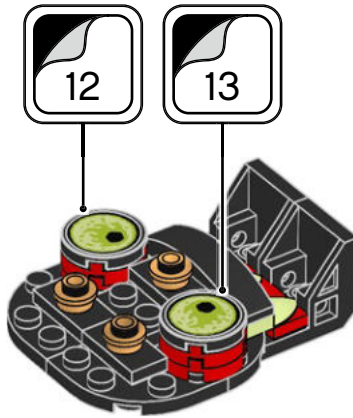

33



34

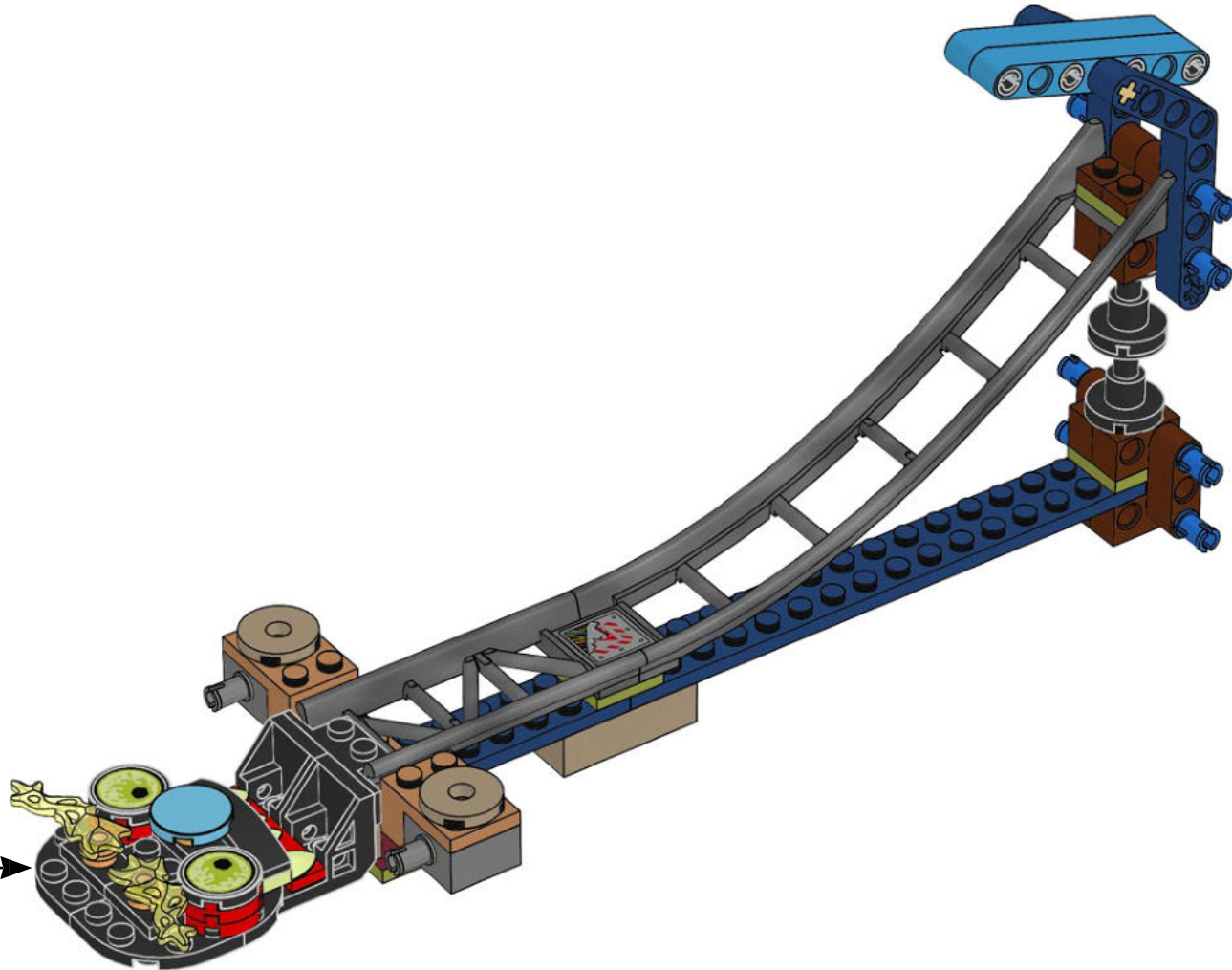



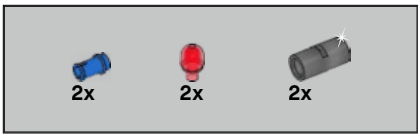

# 36

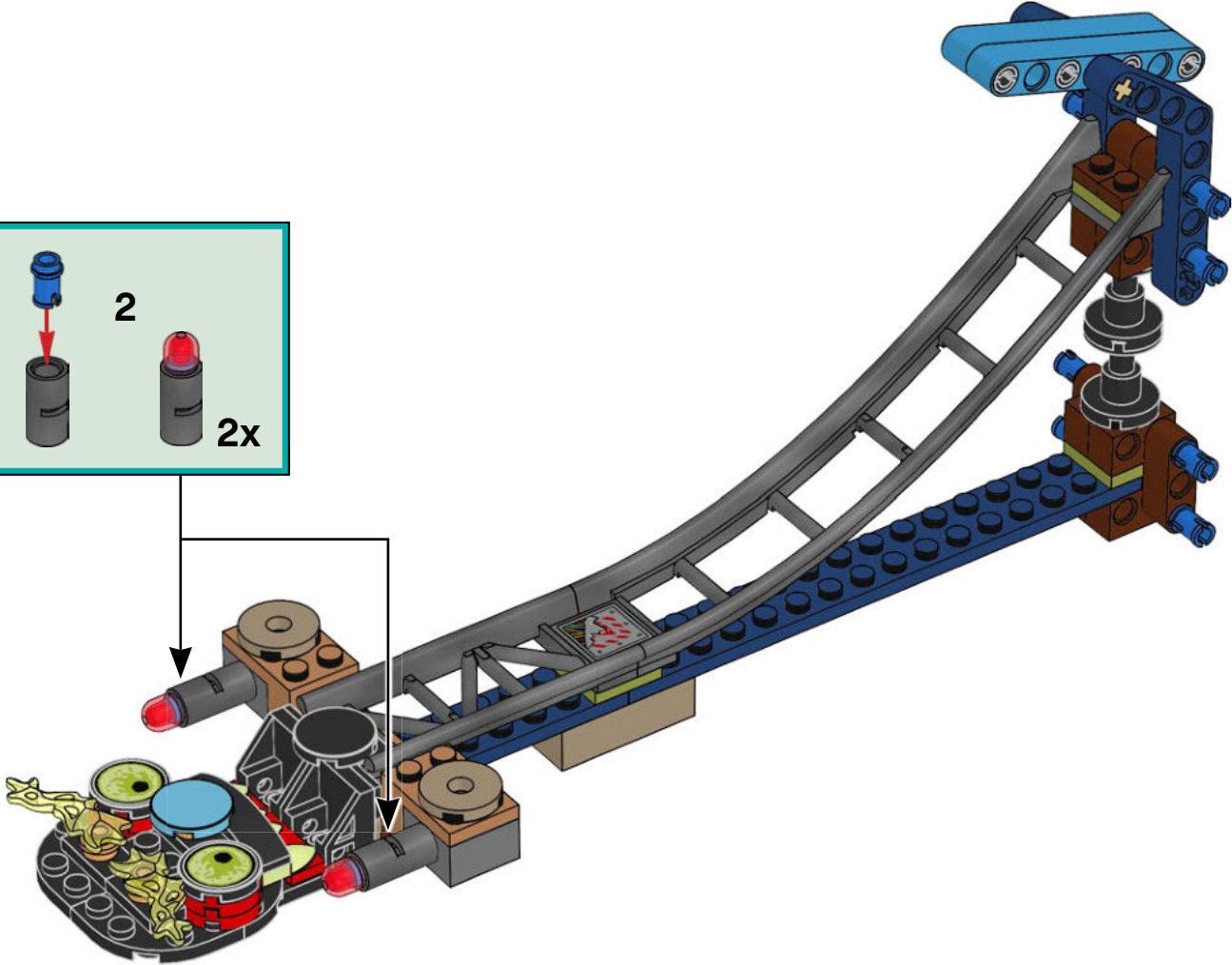
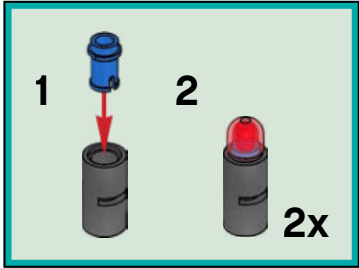

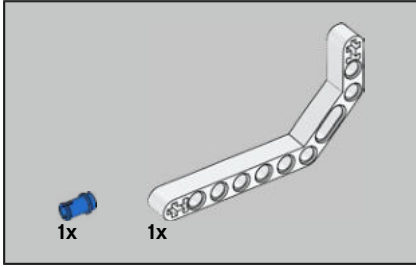
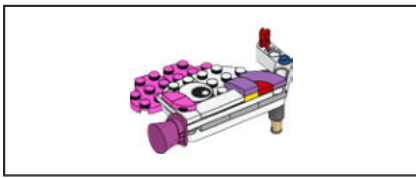

37

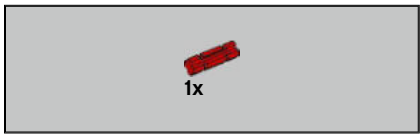
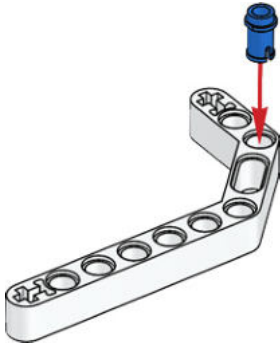

38

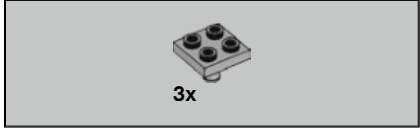
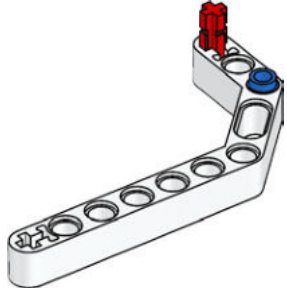

39

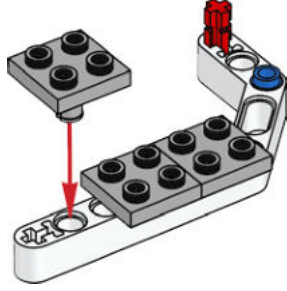



1x

# 40

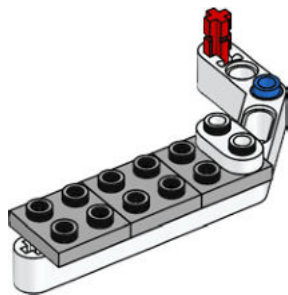

1x

1x

# 41

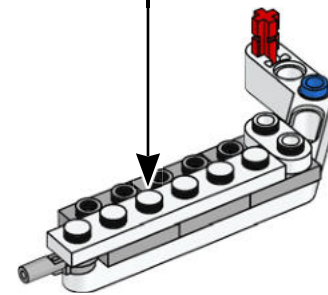
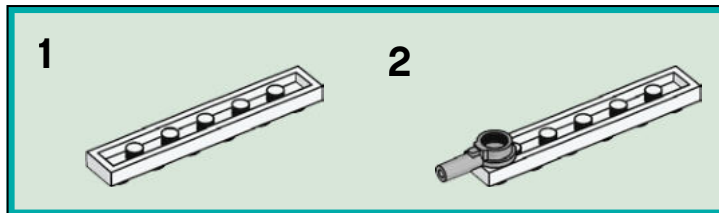

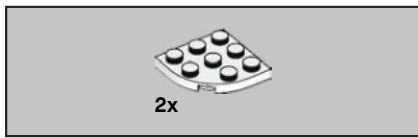

42

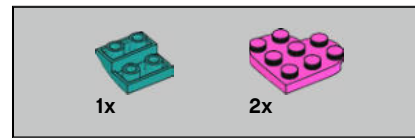
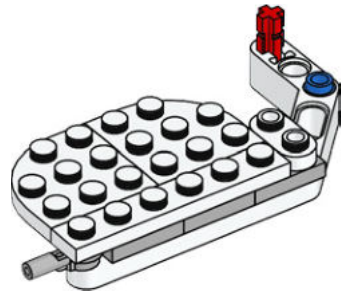

43

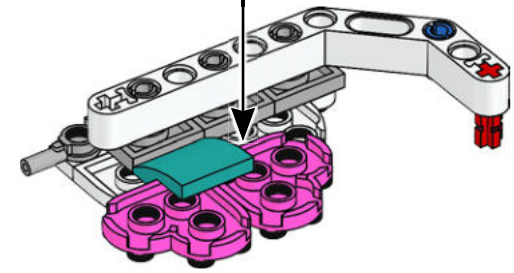
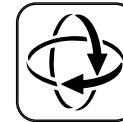
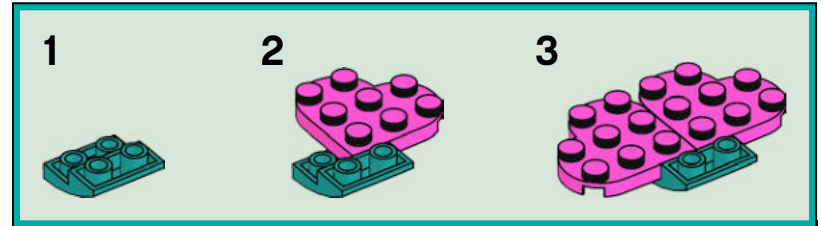

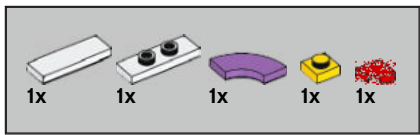

44

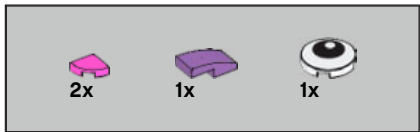
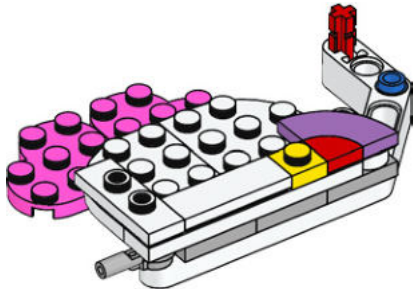

45

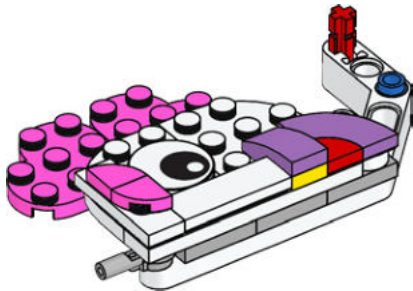

46

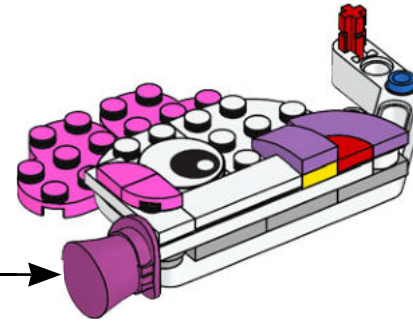
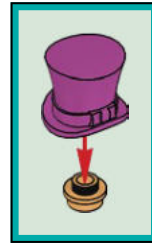

47

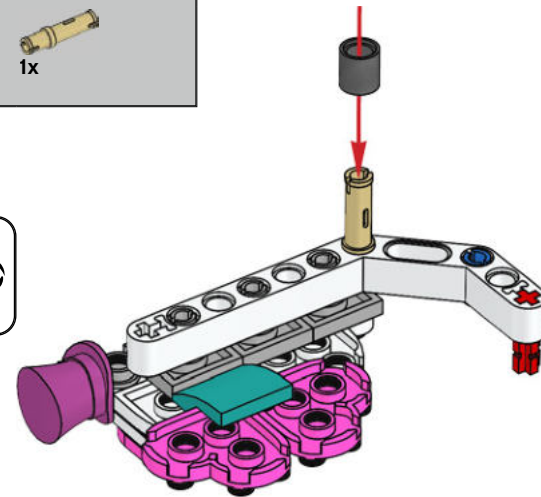
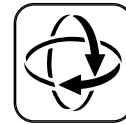



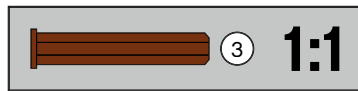
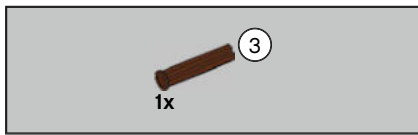

48

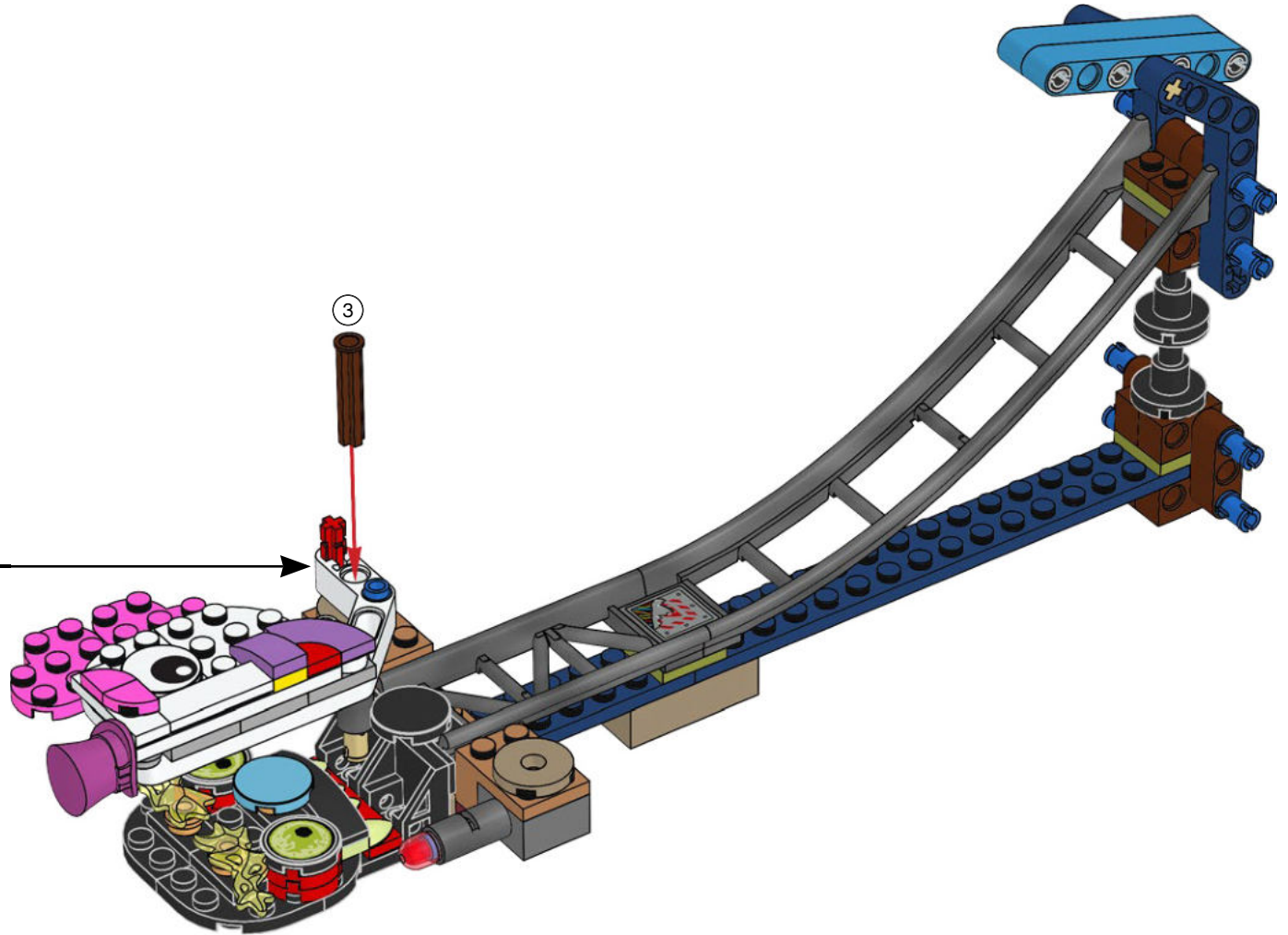

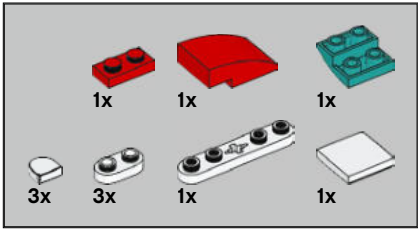
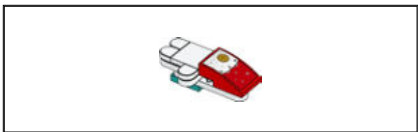

49

1

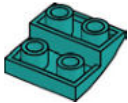

2

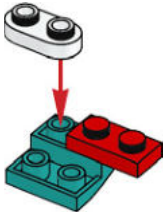

3

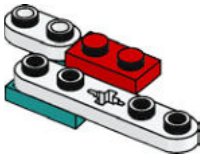

4



5

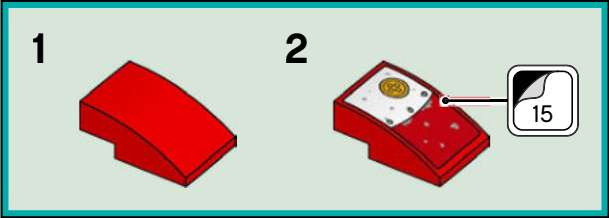
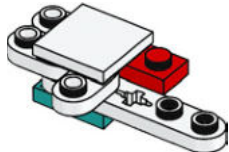

6

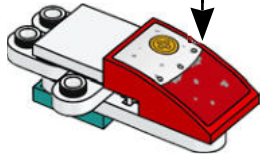

7

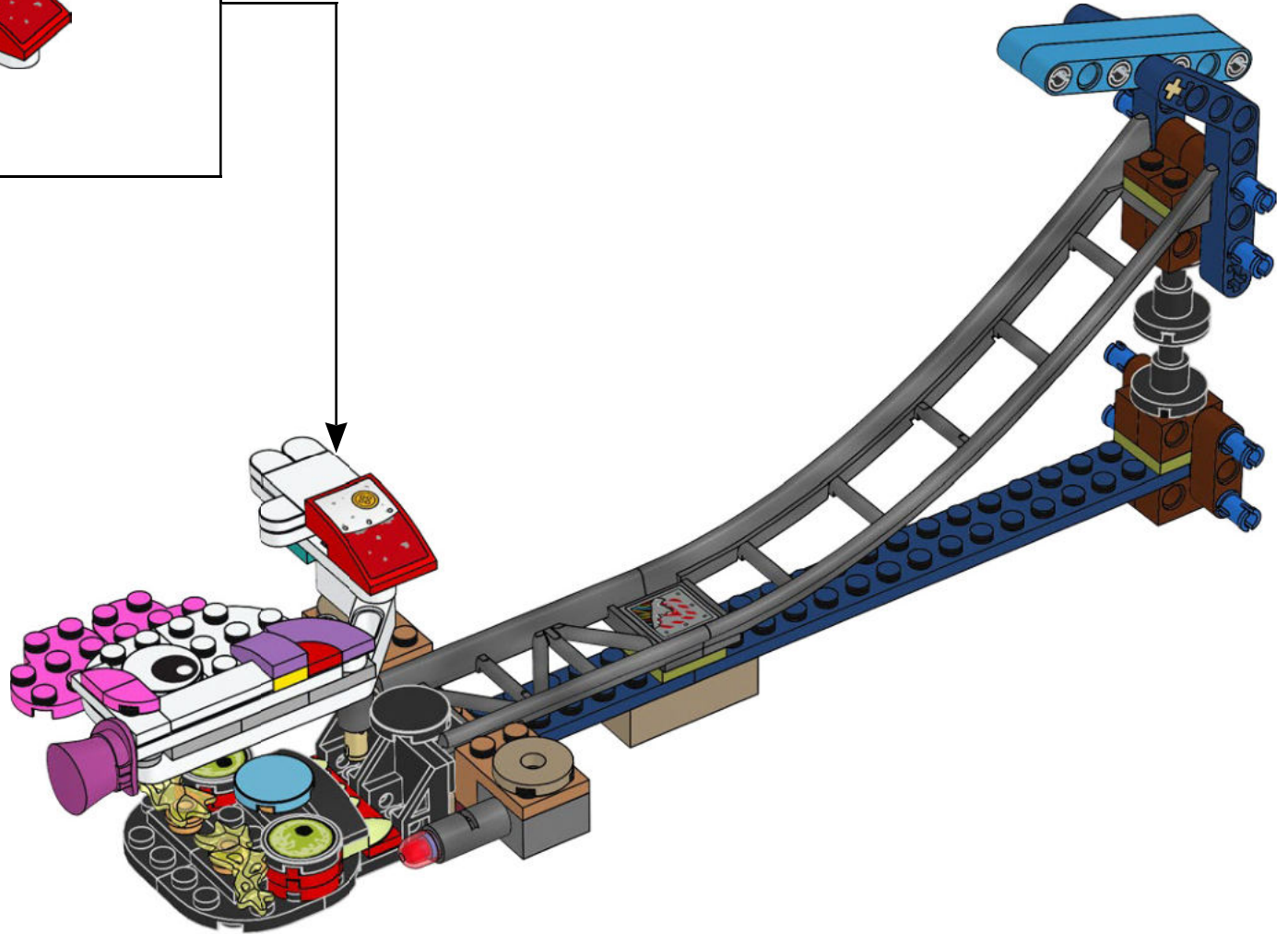
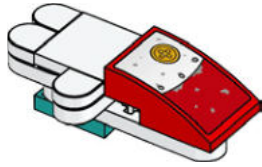

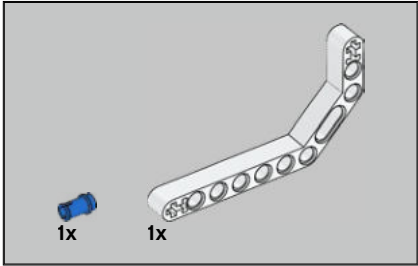
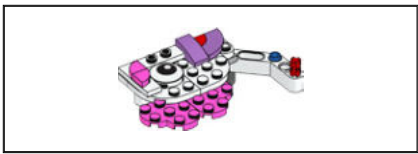

50

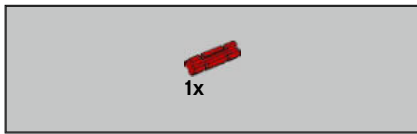
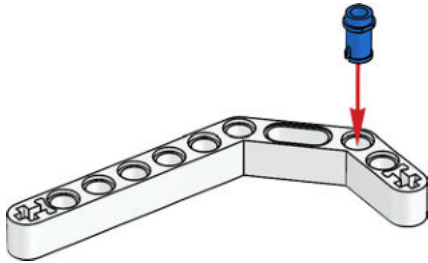

51

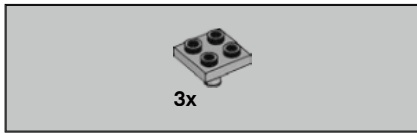
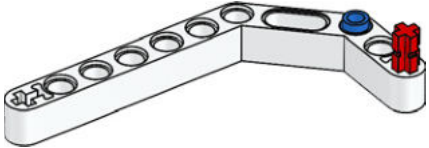

52

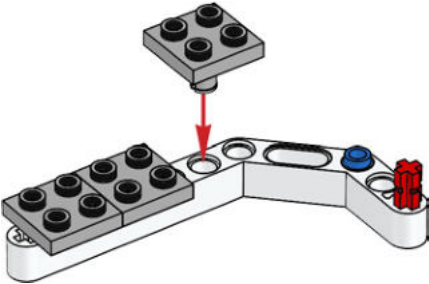

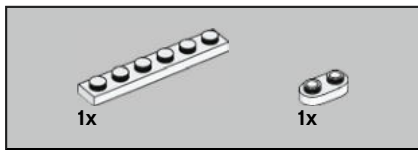

**53**

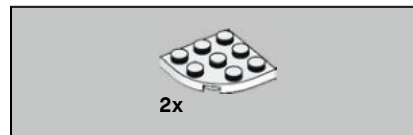
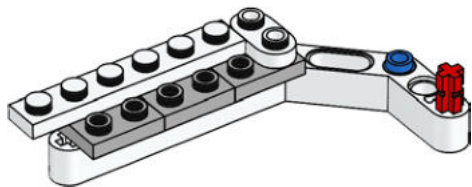

**54**





# 55

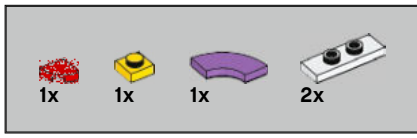
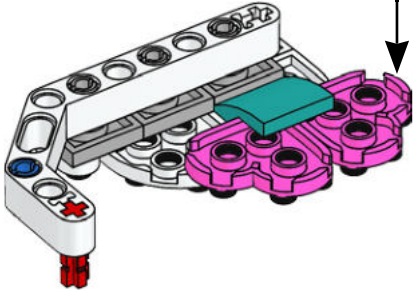
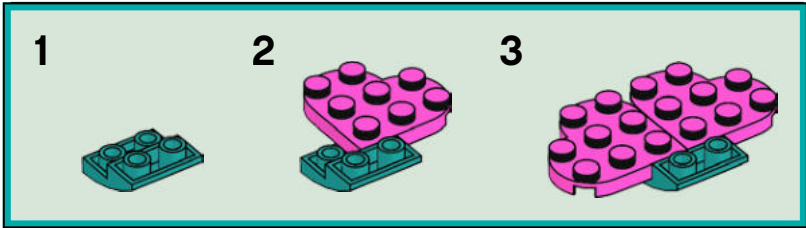

# 56

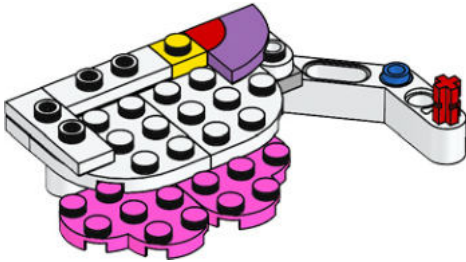

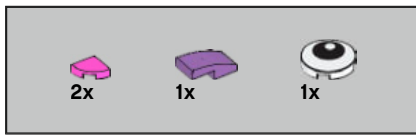

57

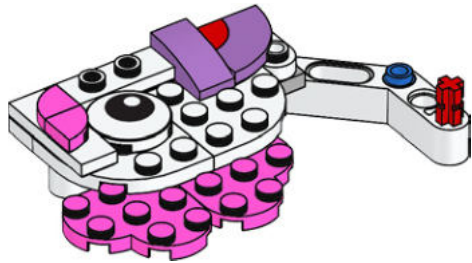

58

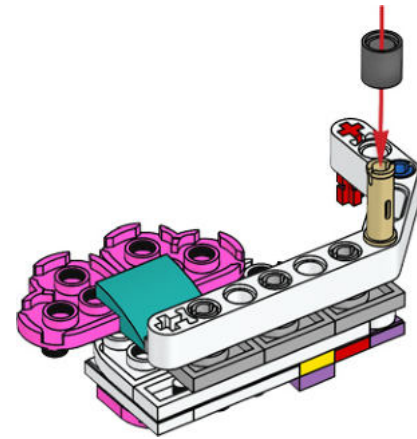
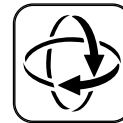

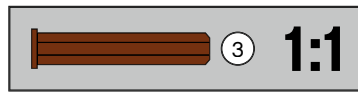
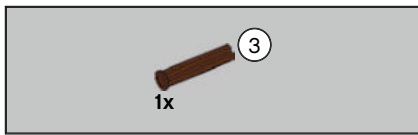

59

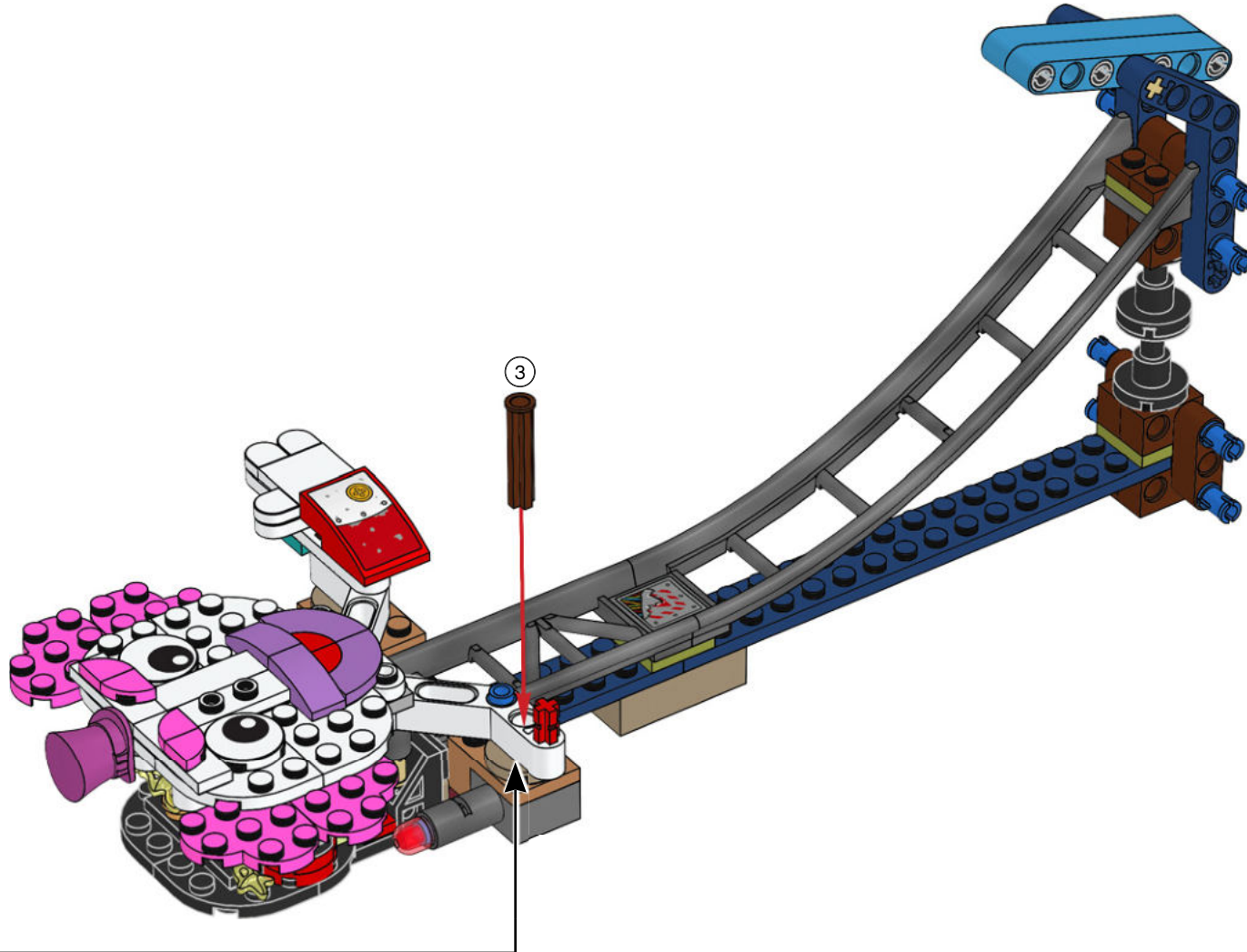



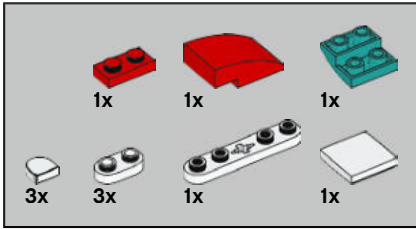

60

1

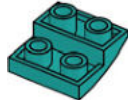

2

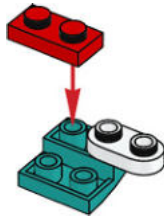

3



4

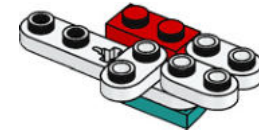

5

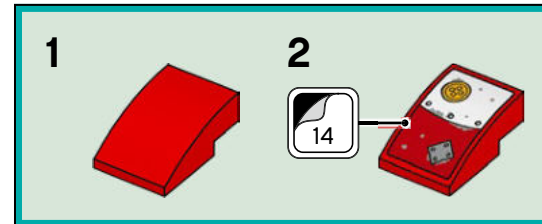

6

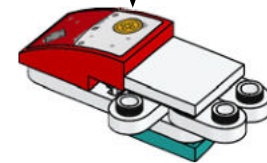

7

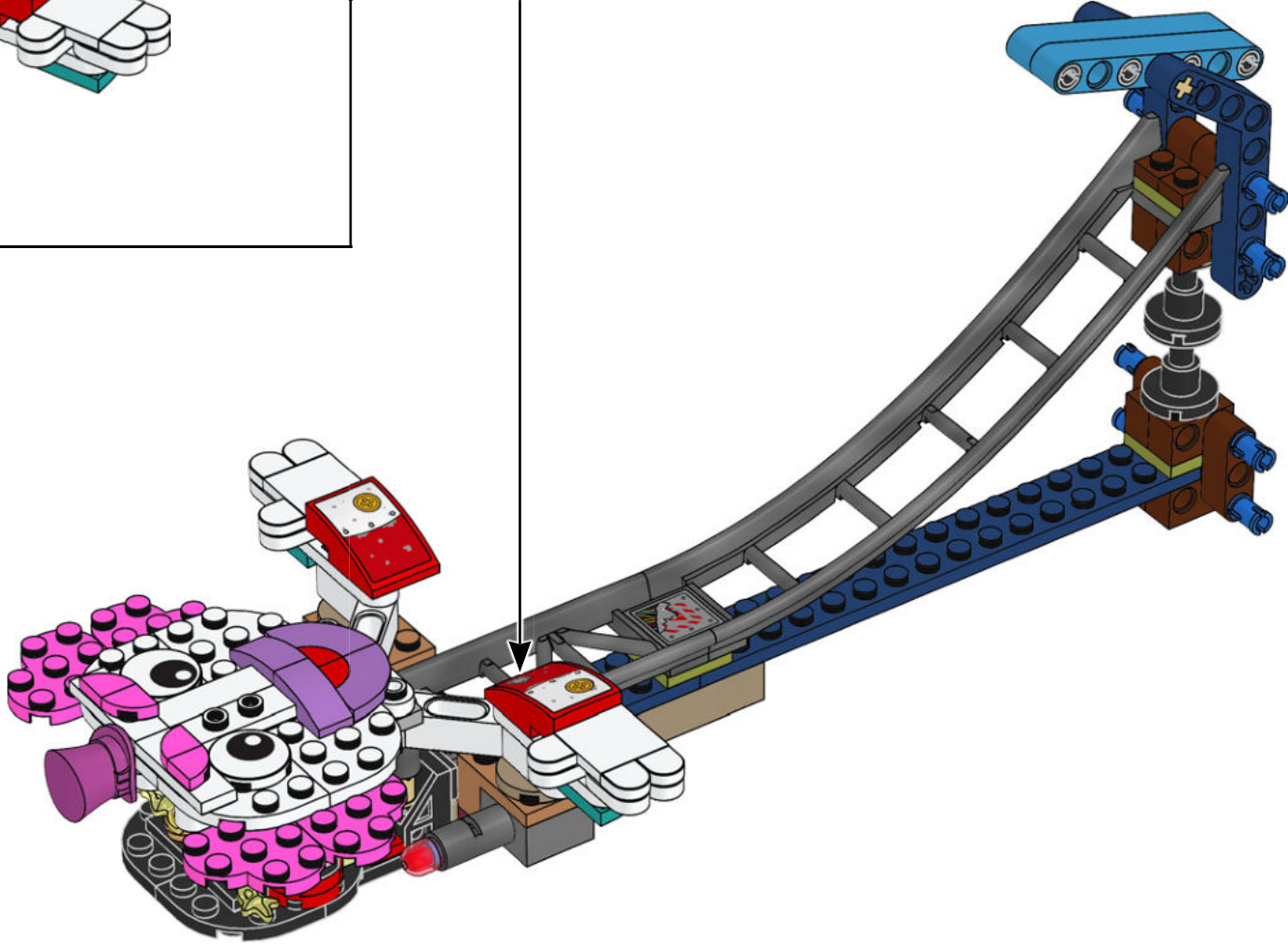
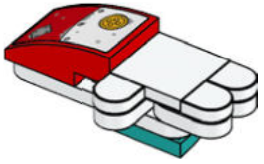



61

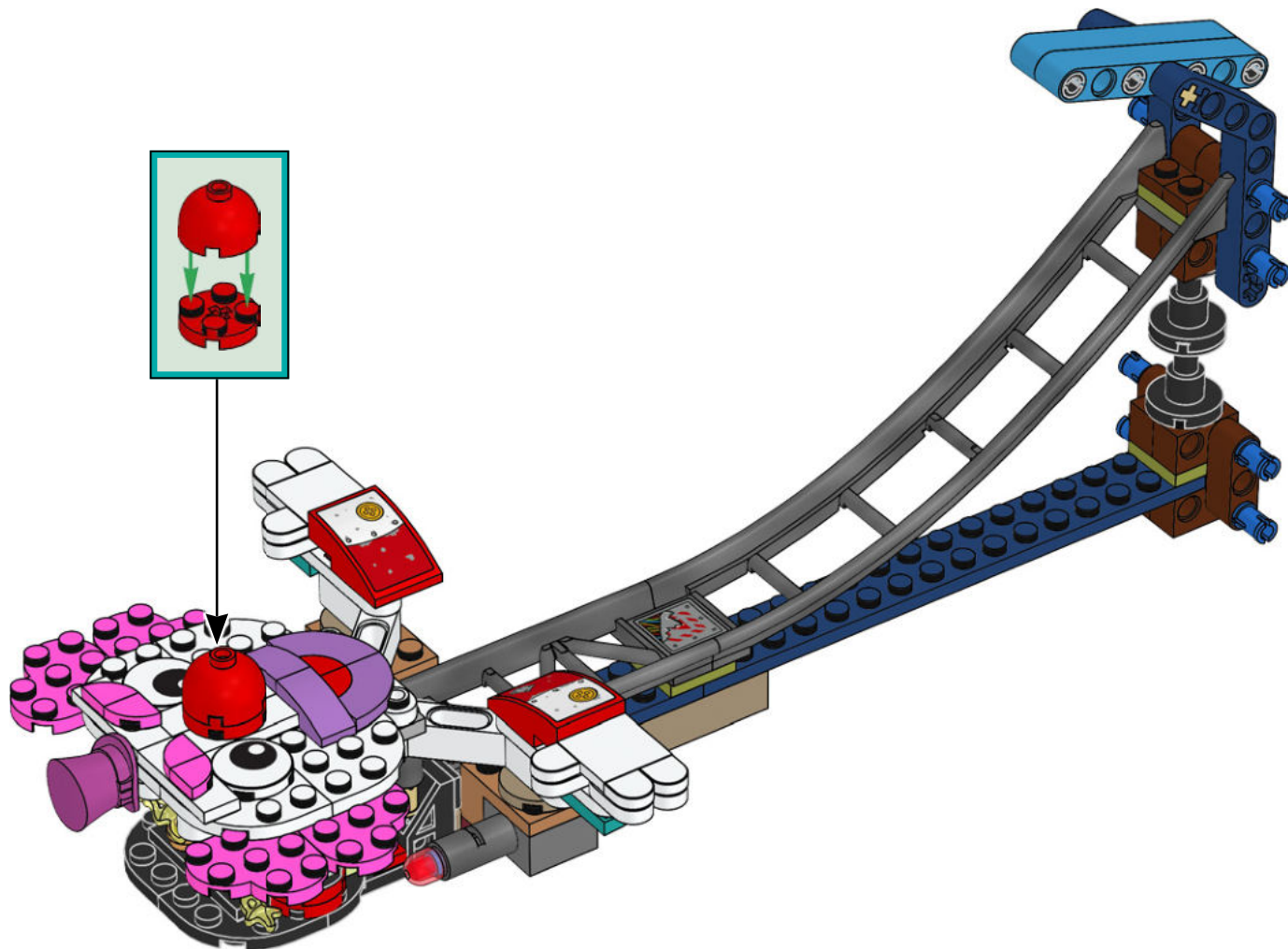

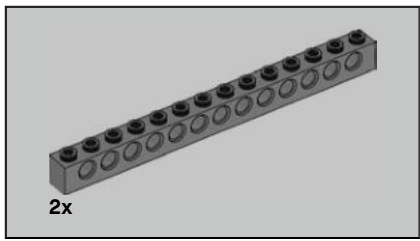

62



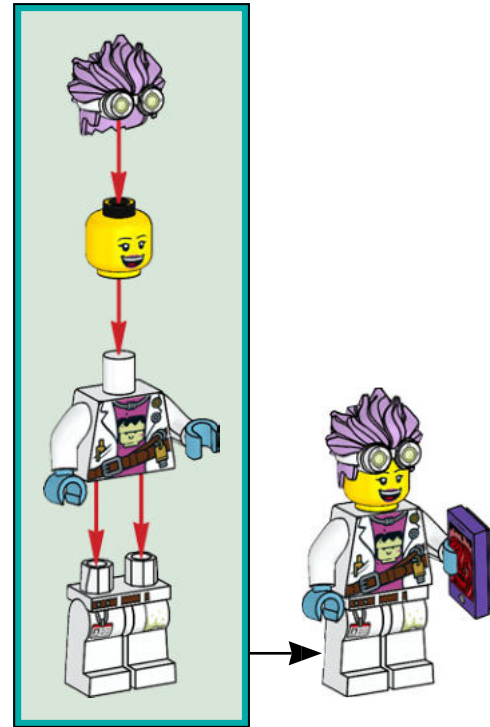
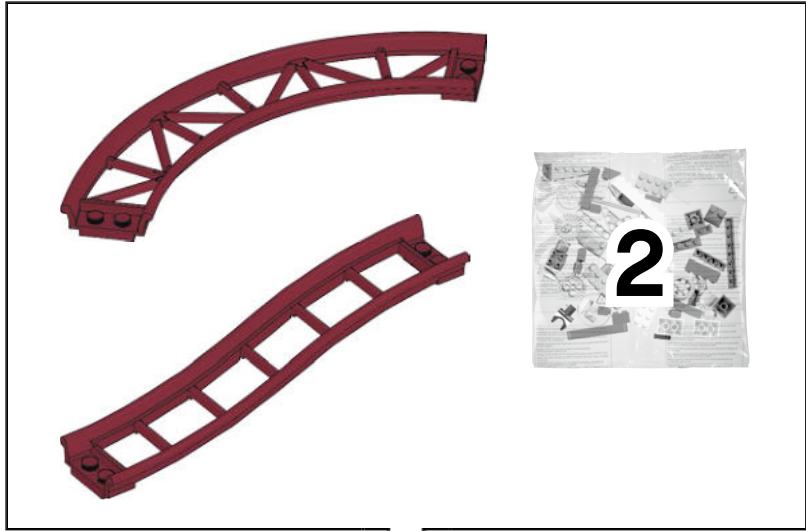

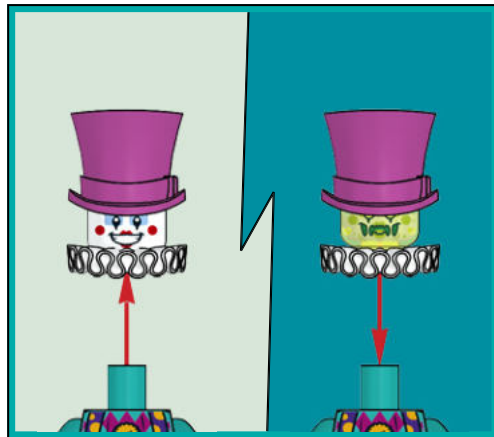
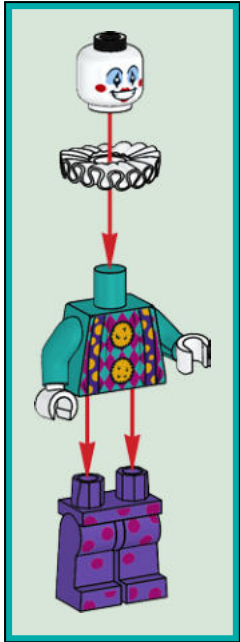

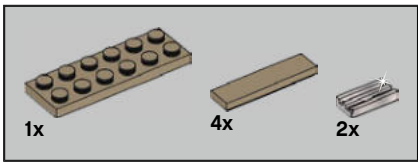

63

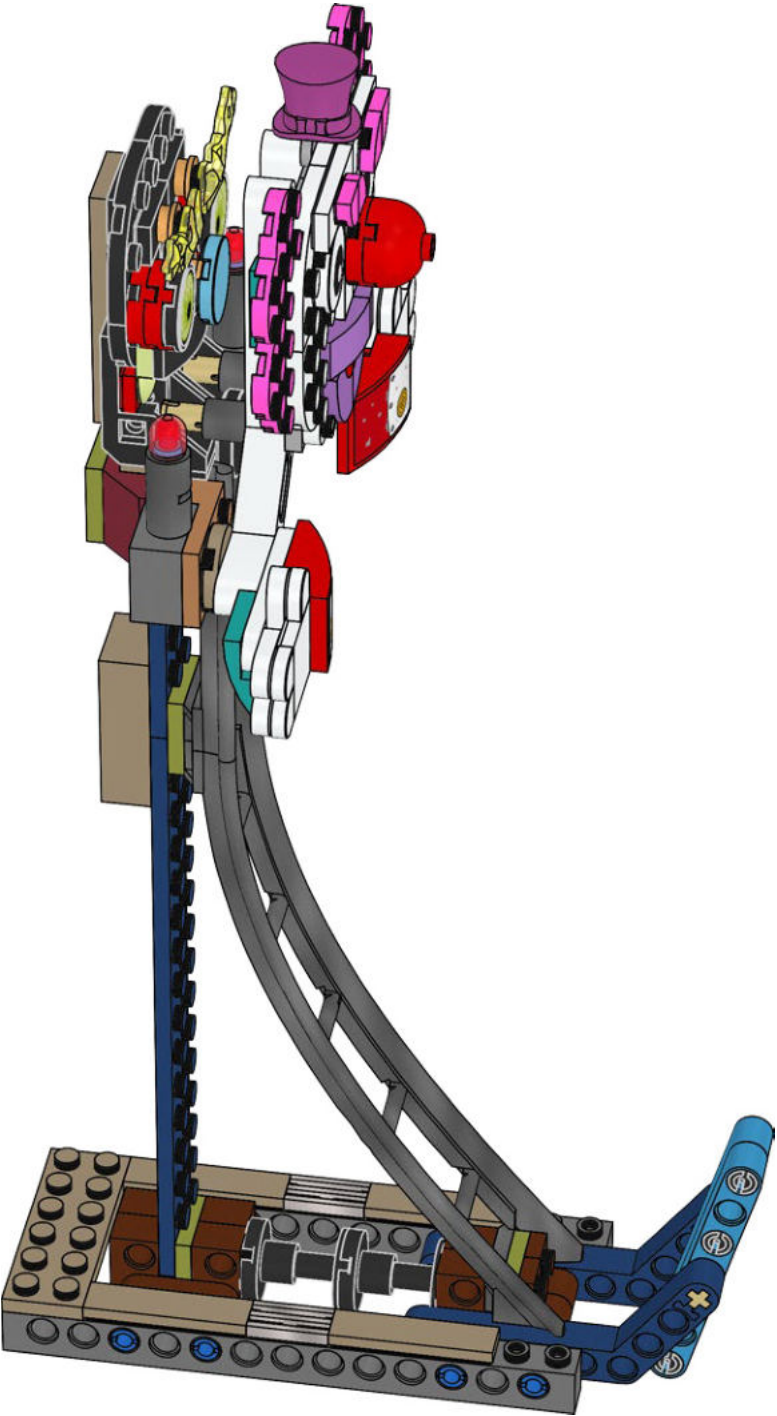

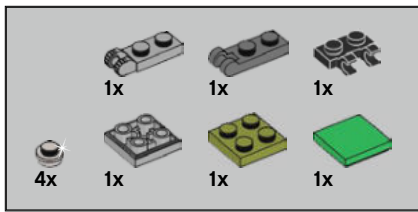

# 64

1



2

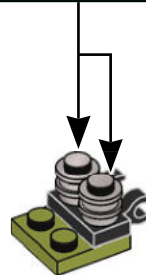
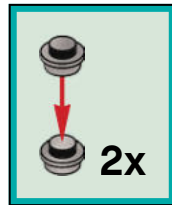

3

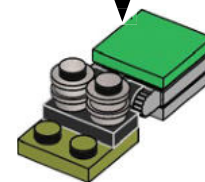
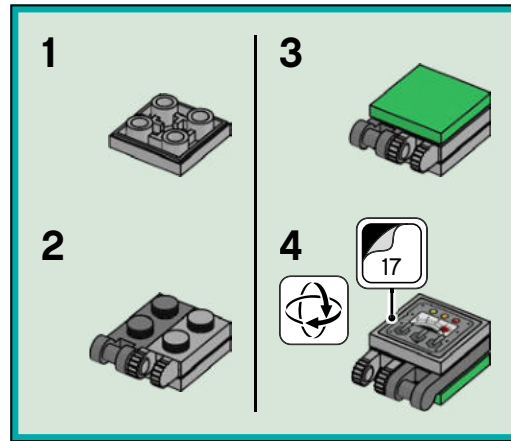



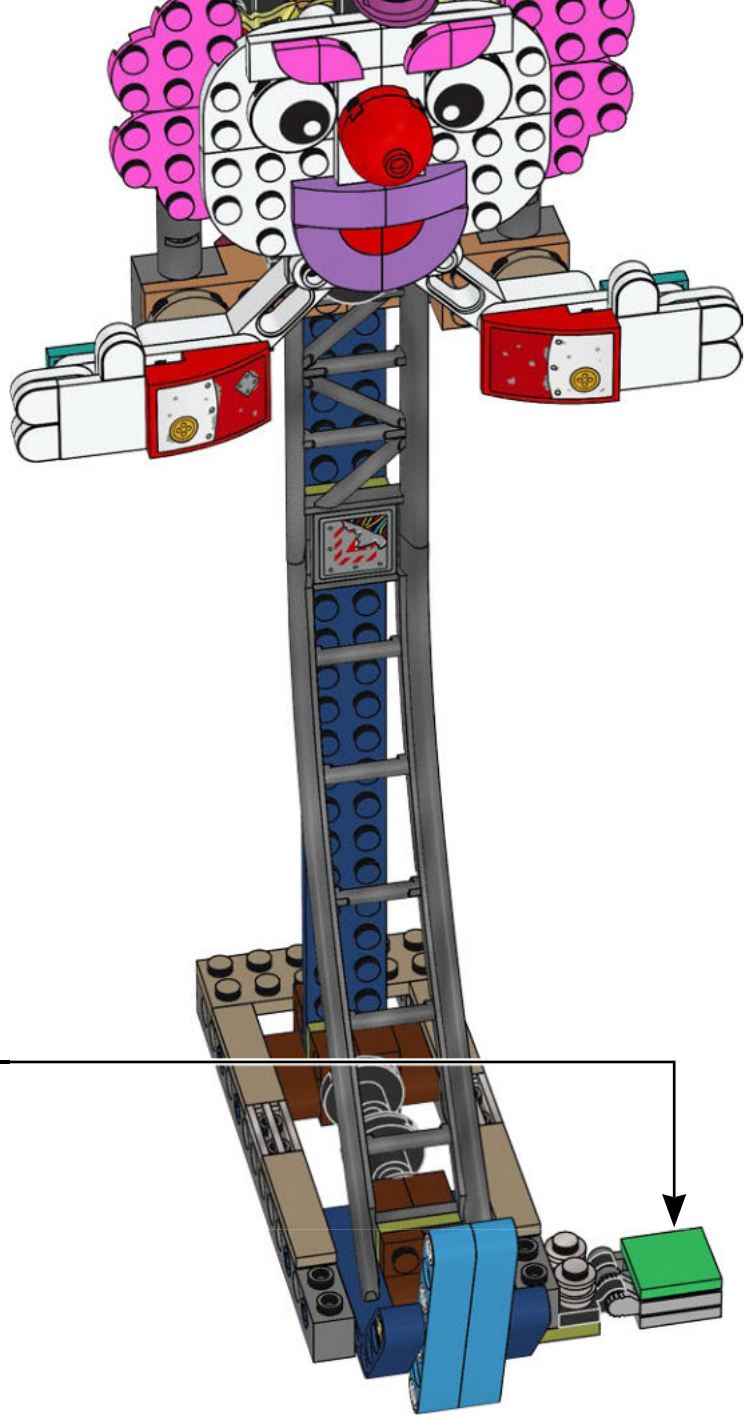

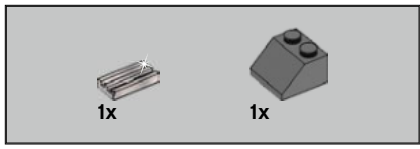

65

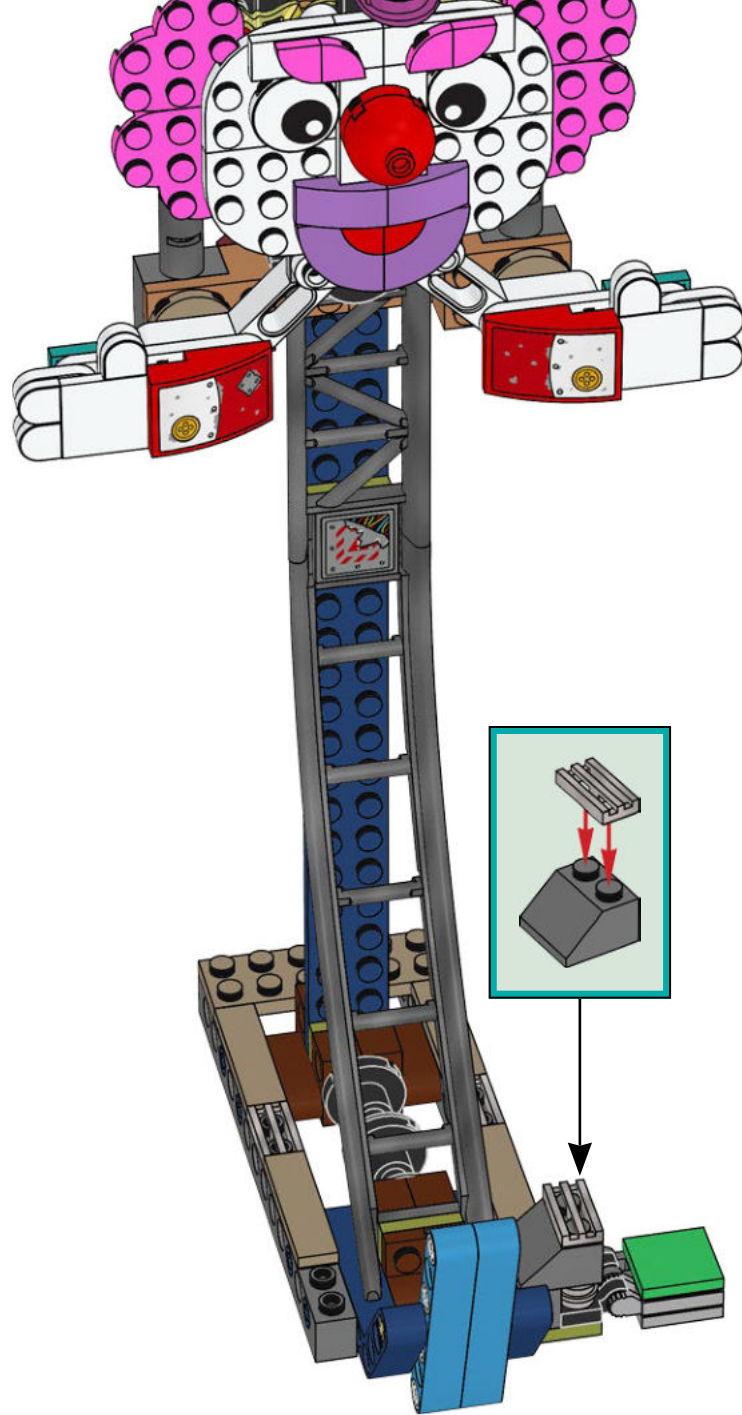

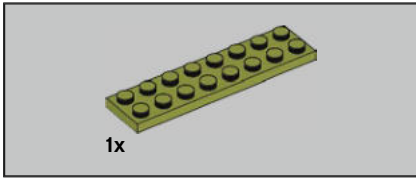
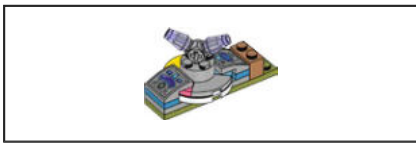

66

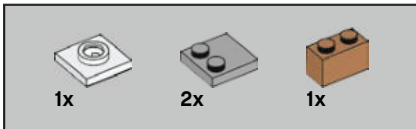
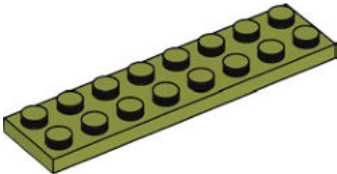

67

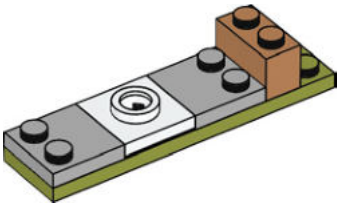

68

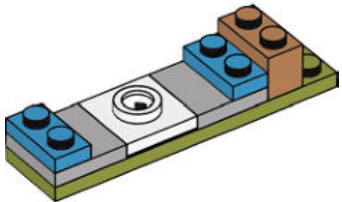

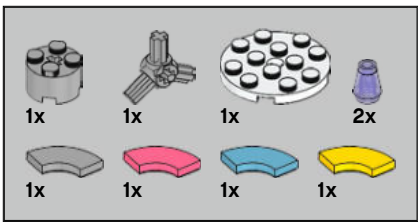

# 69

1



2

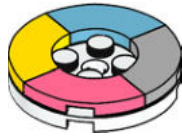

3

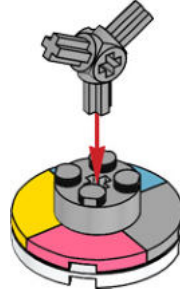

4

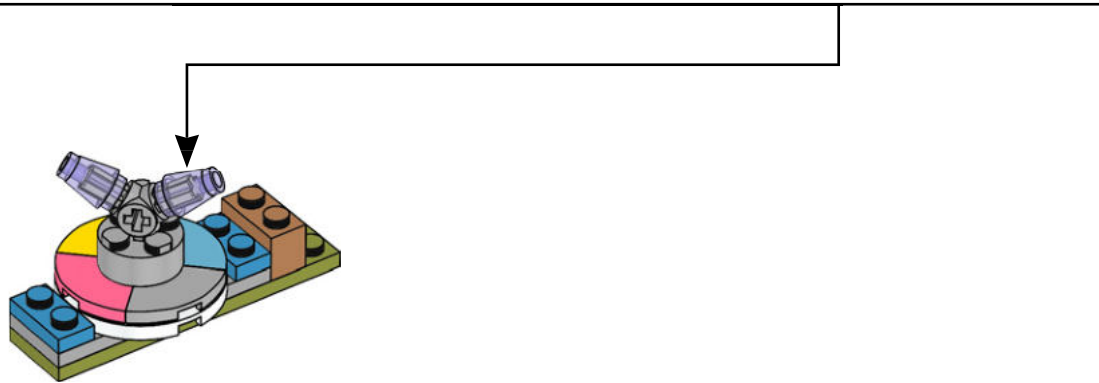
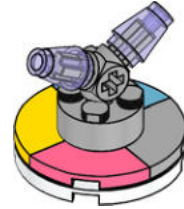

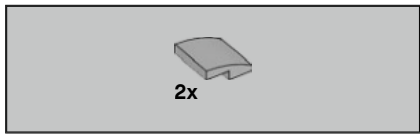

70

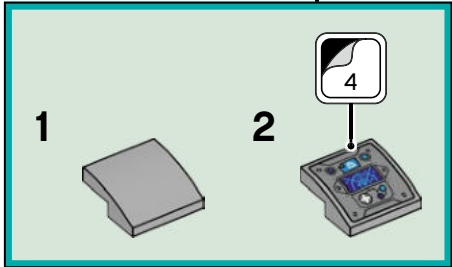
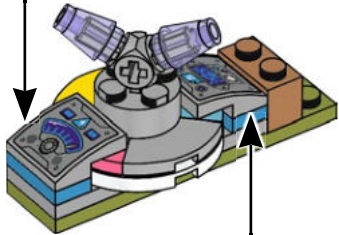
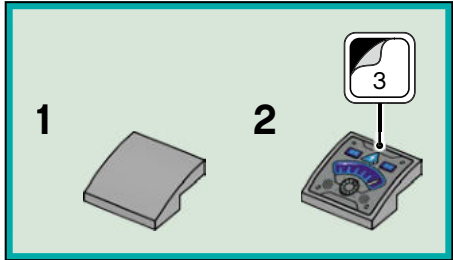

71

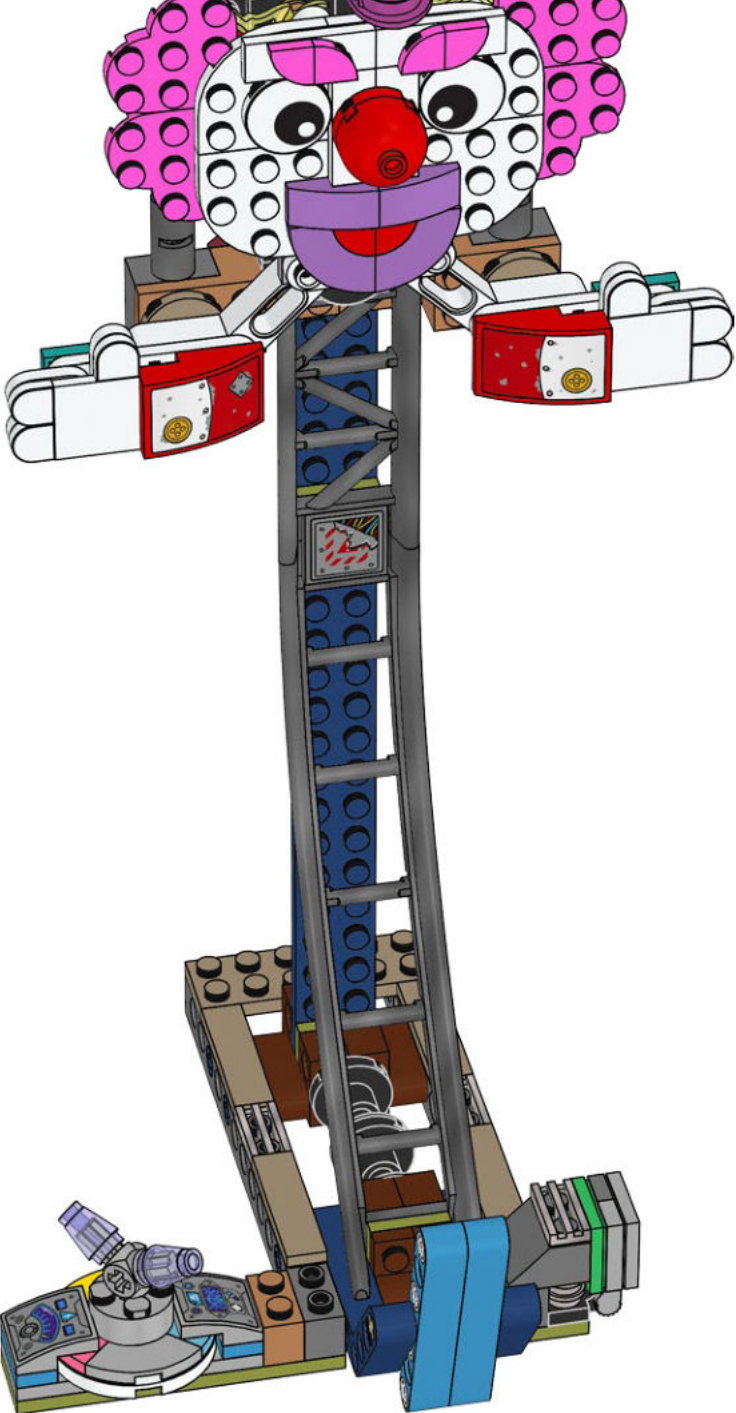



1x

72

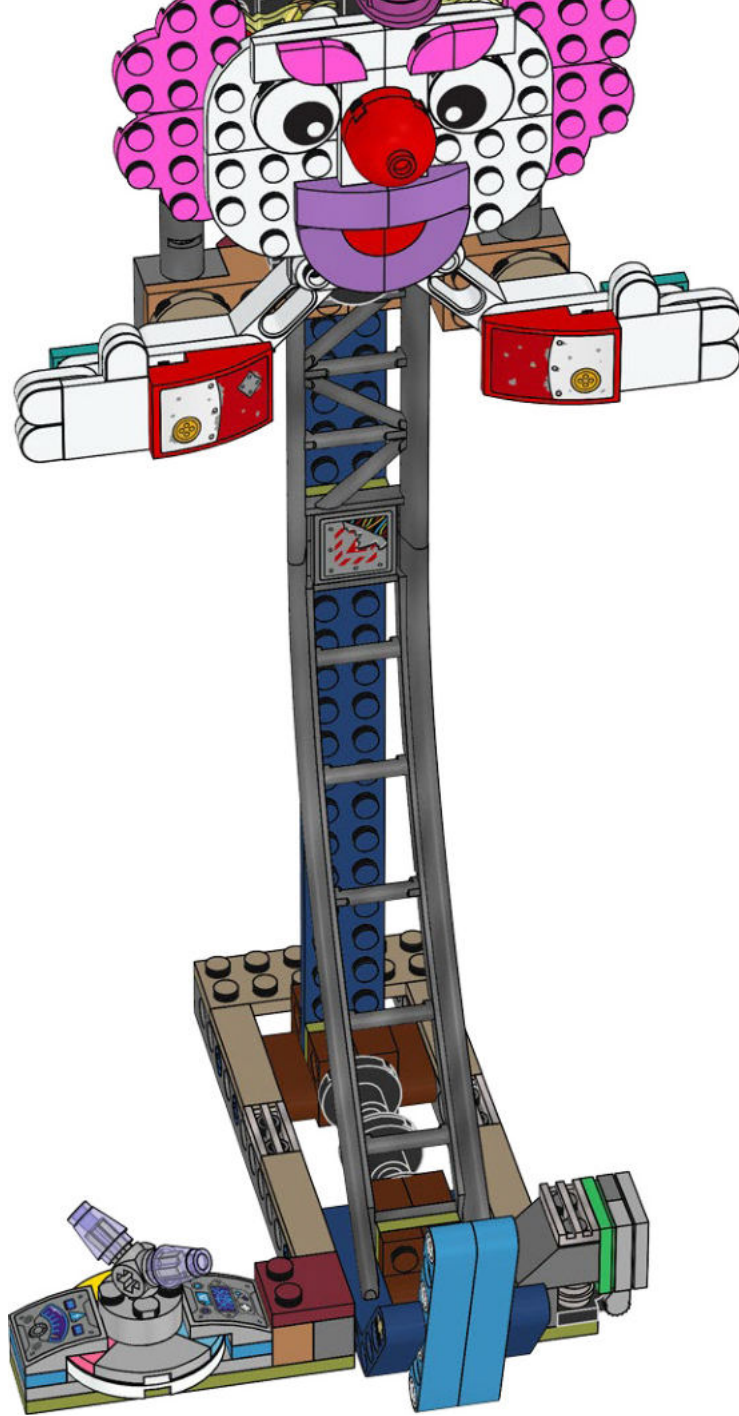

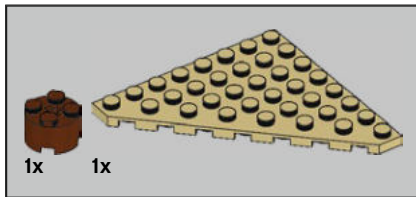
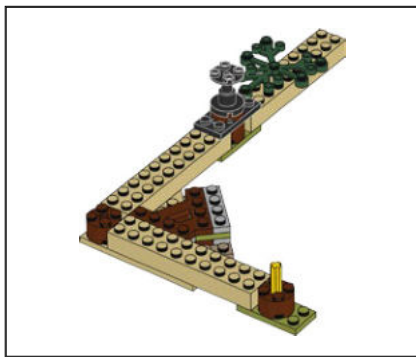

73

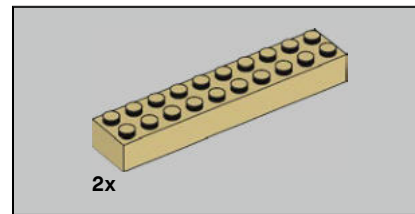
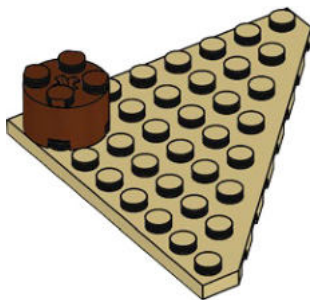

74

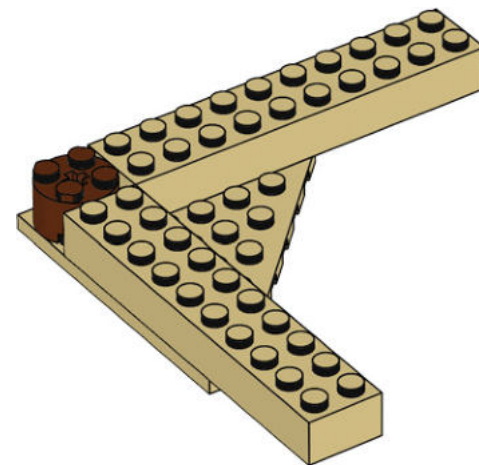

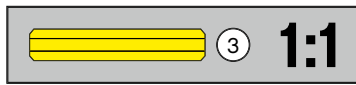
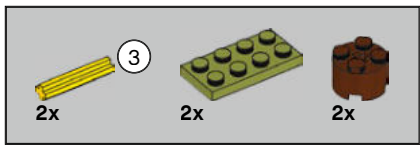

75

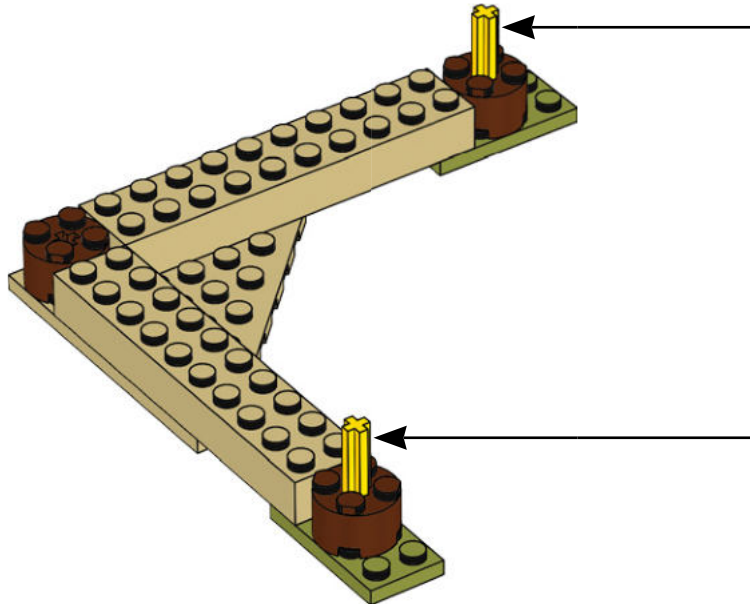
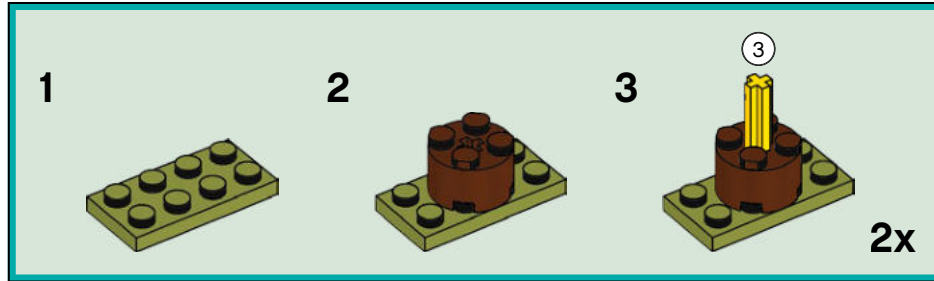



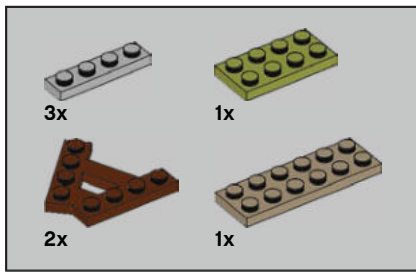

76

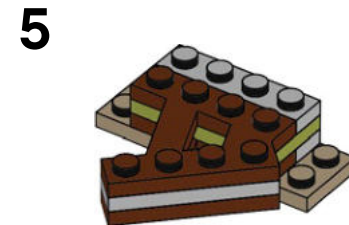
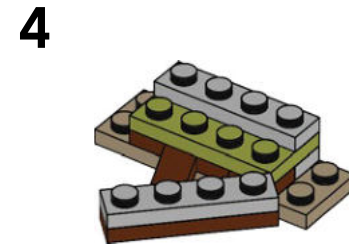
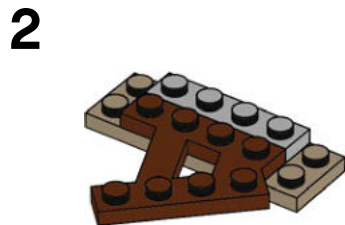
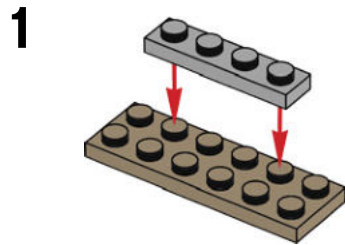

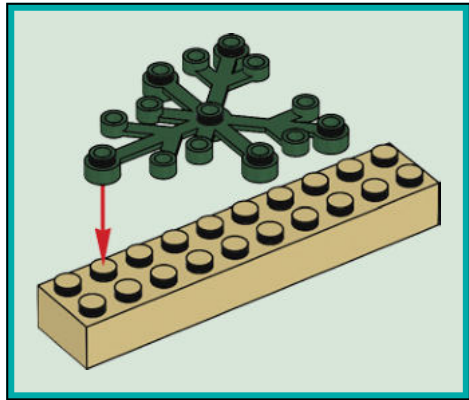
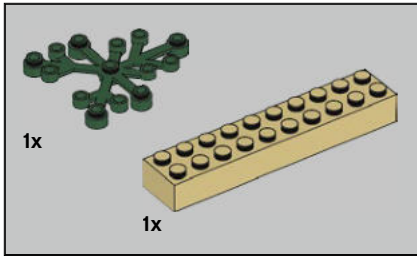

77

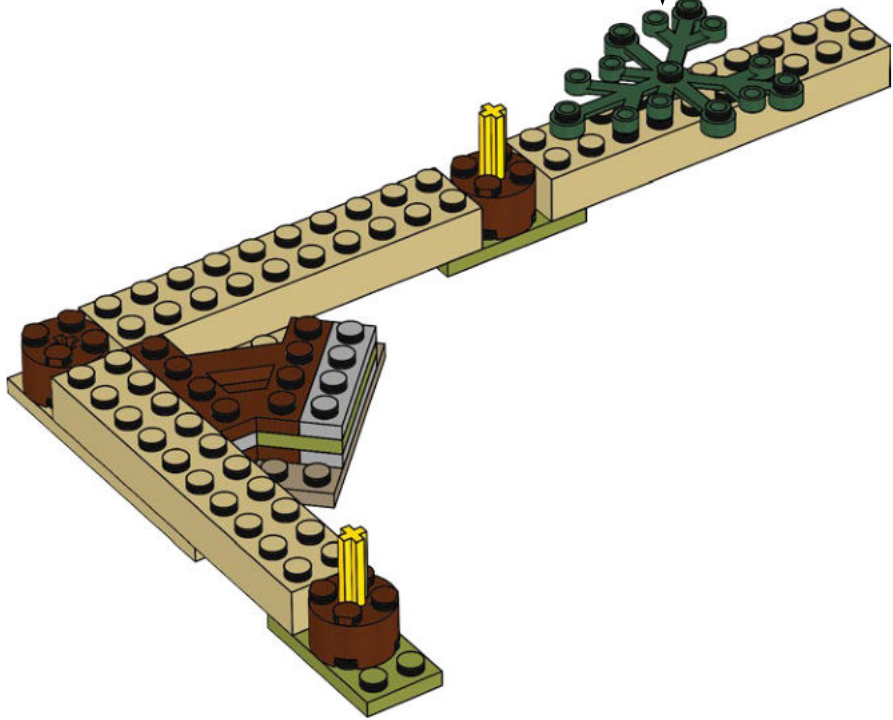
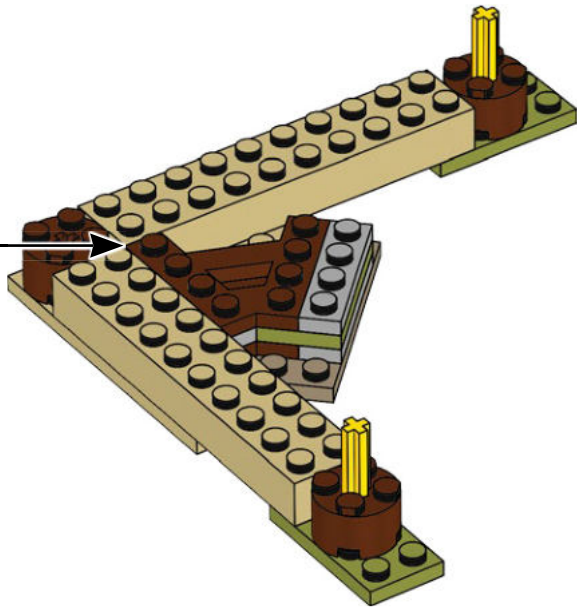

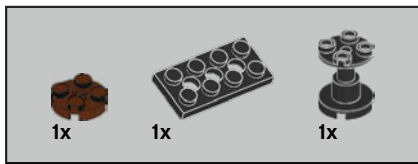

78

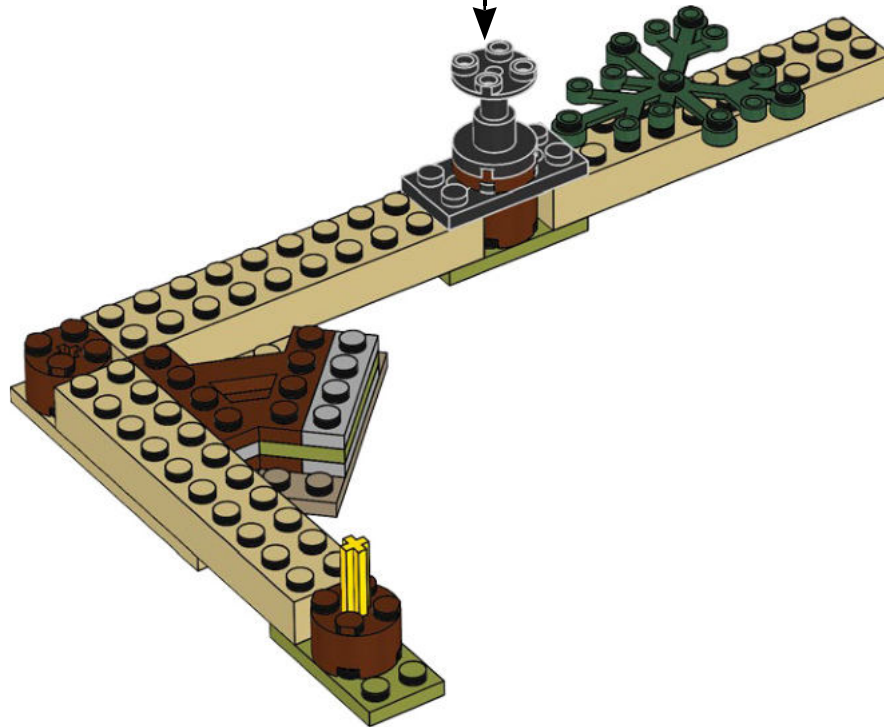
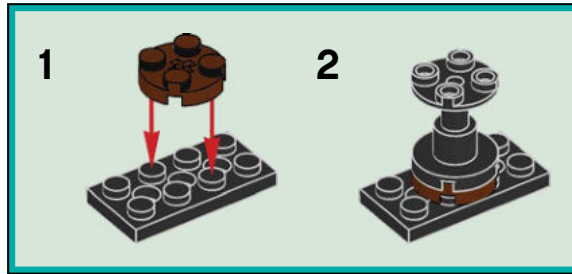

79

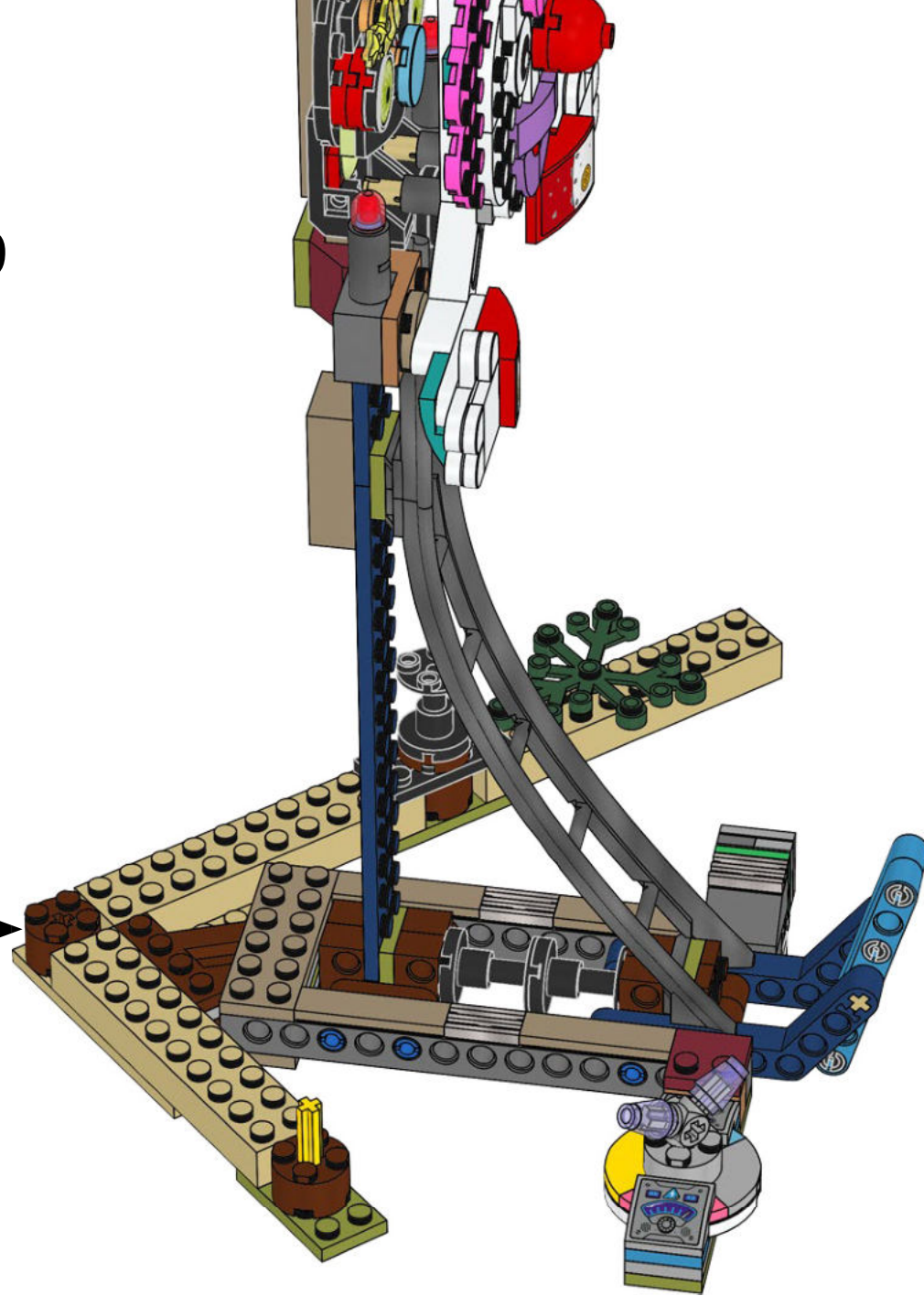

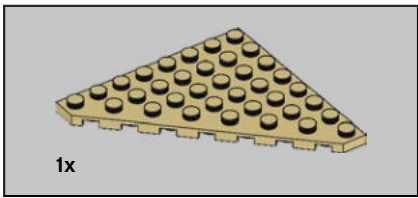

80

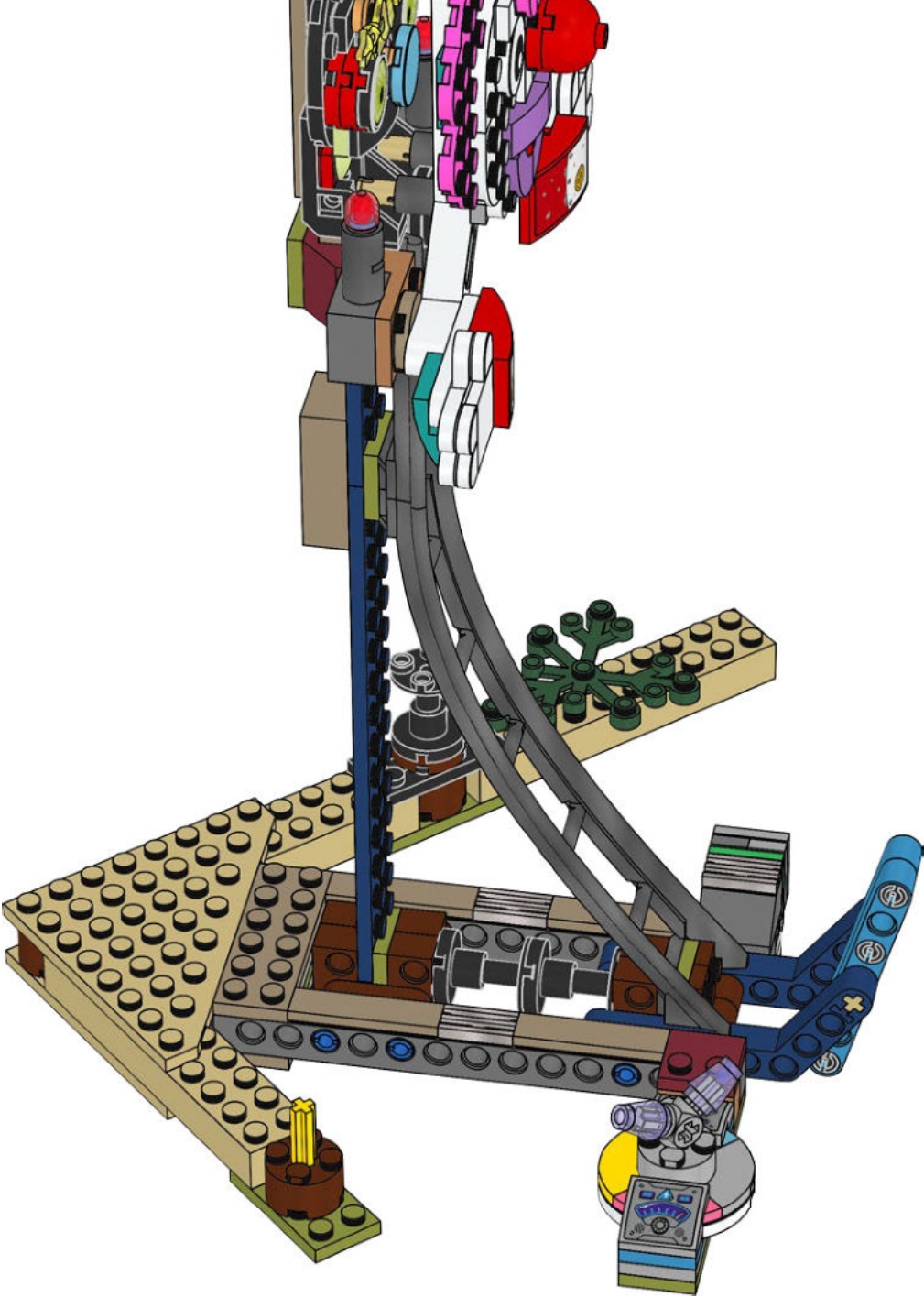





85

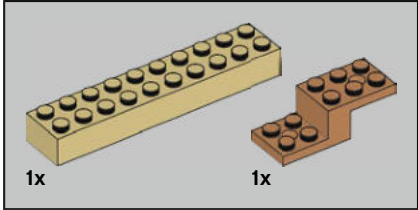
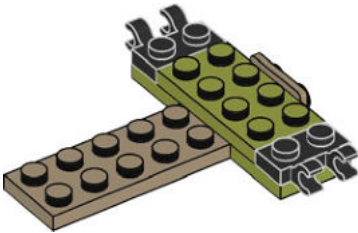

86

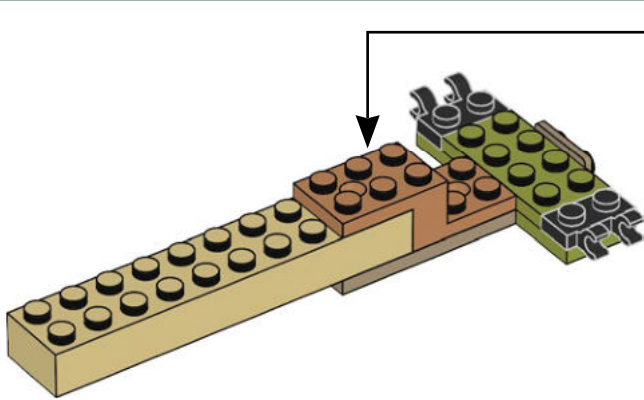
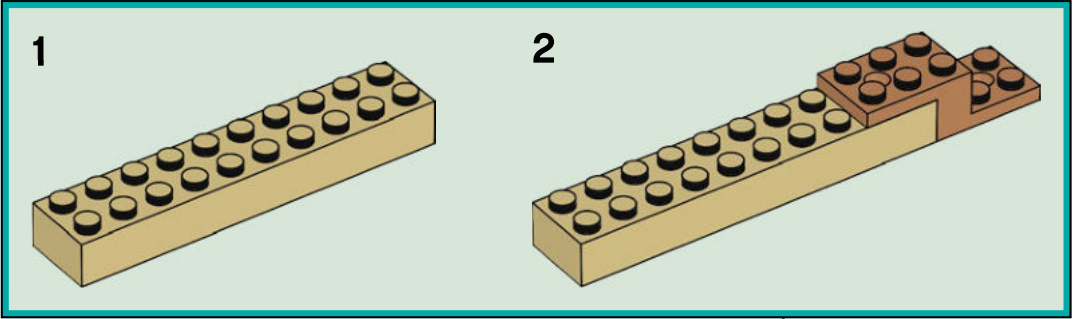

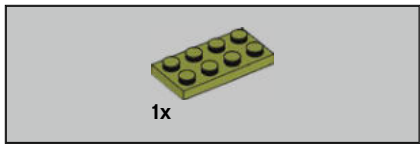

87

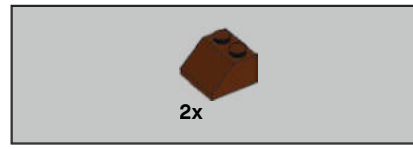
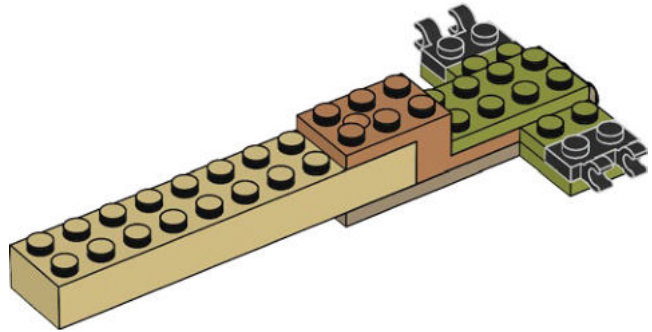

88

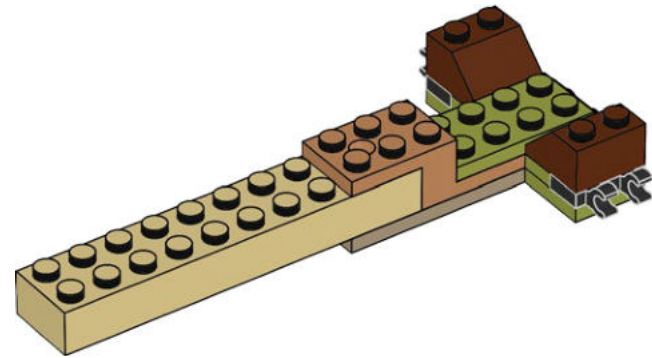



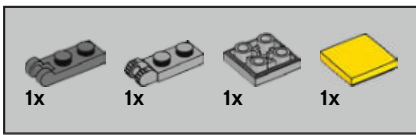

89

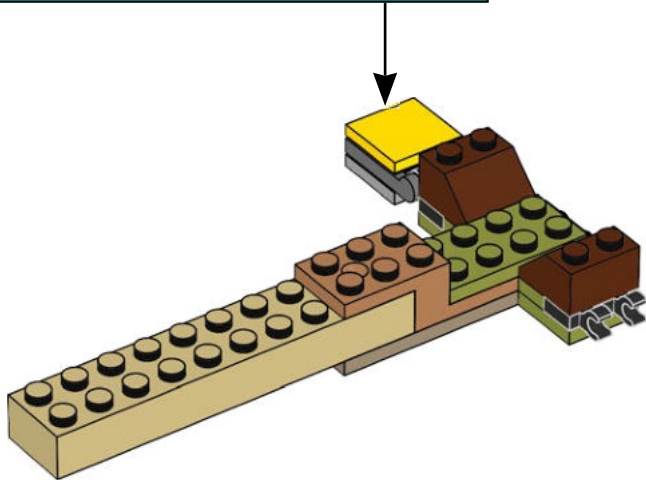
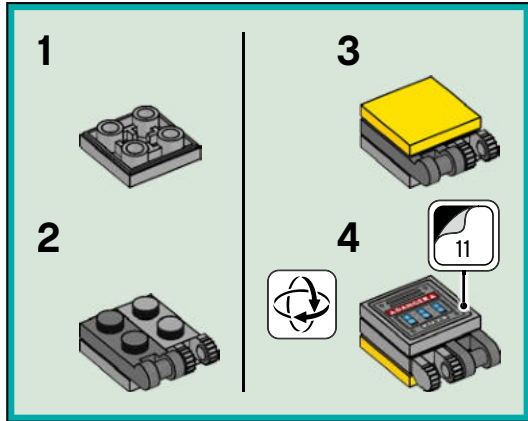

90

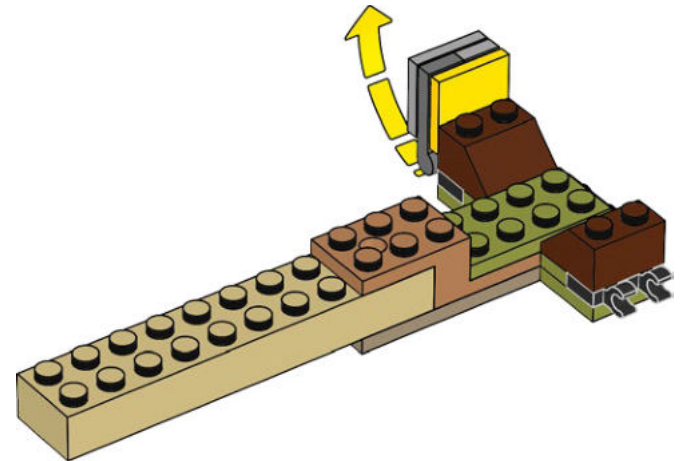

91

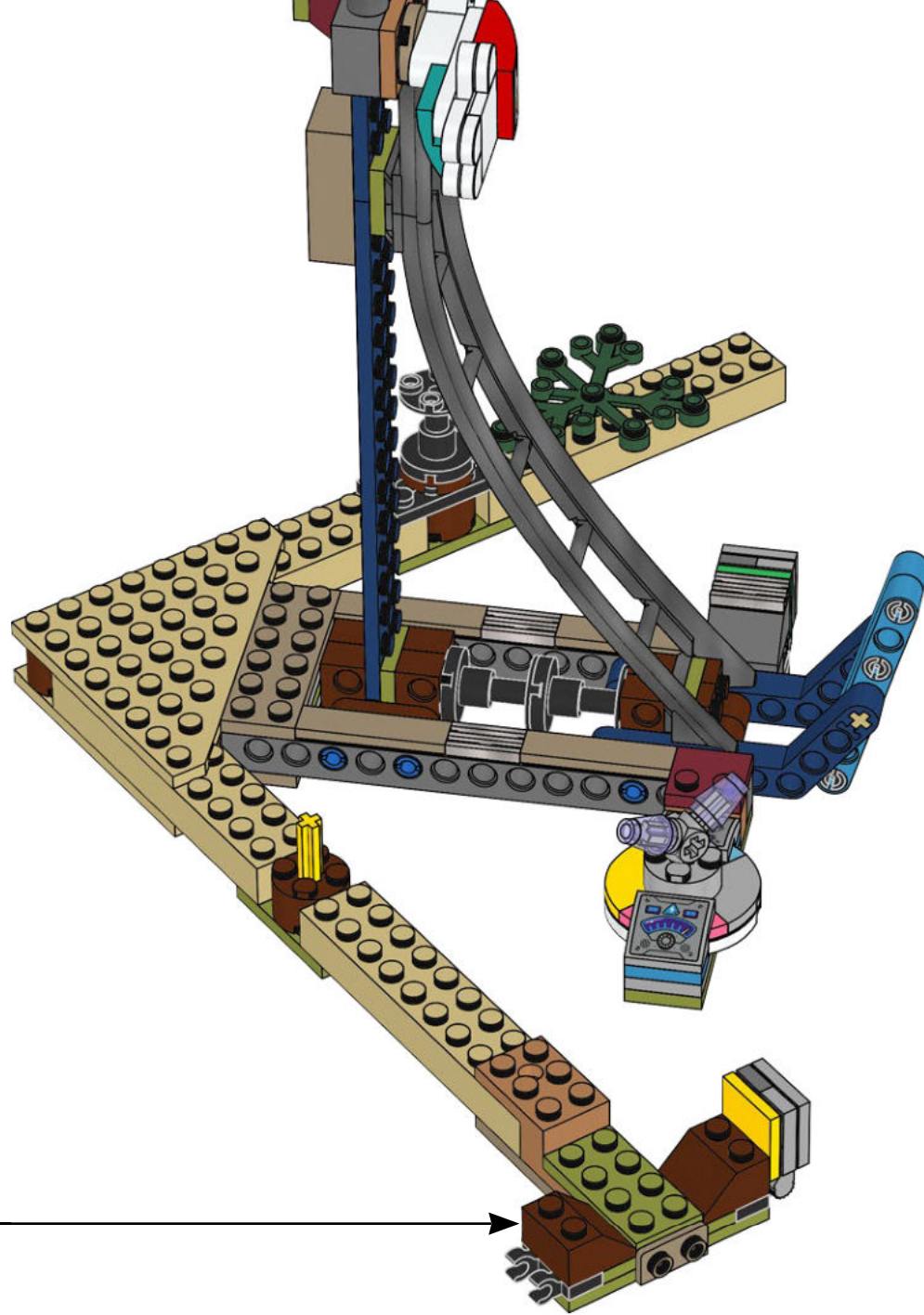

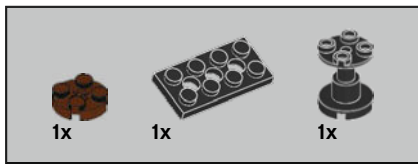

92

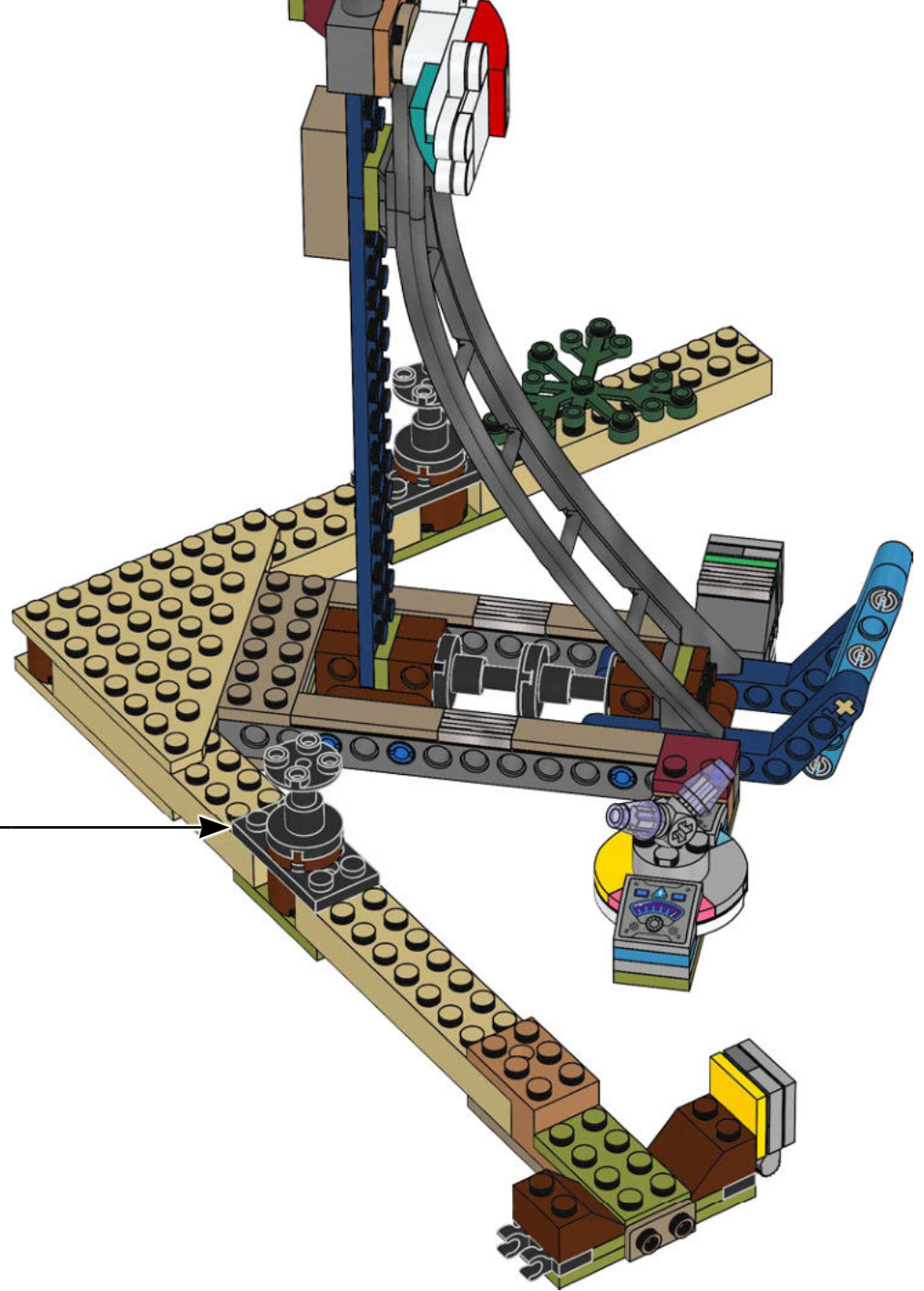
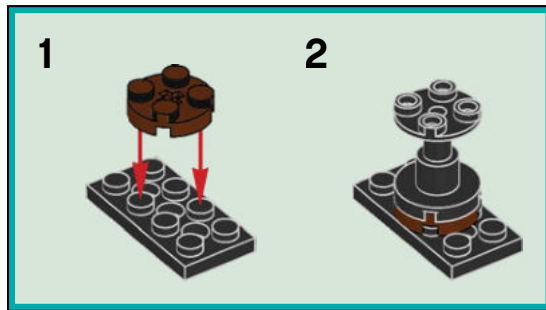

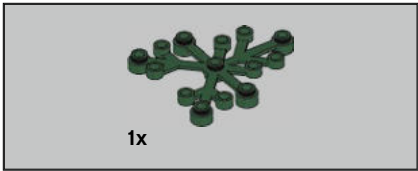

93





94



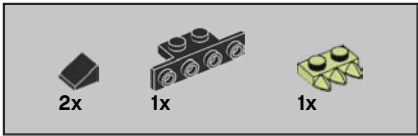

95

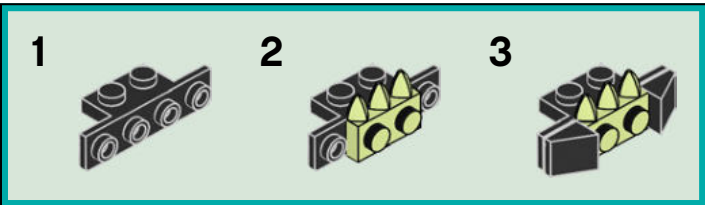
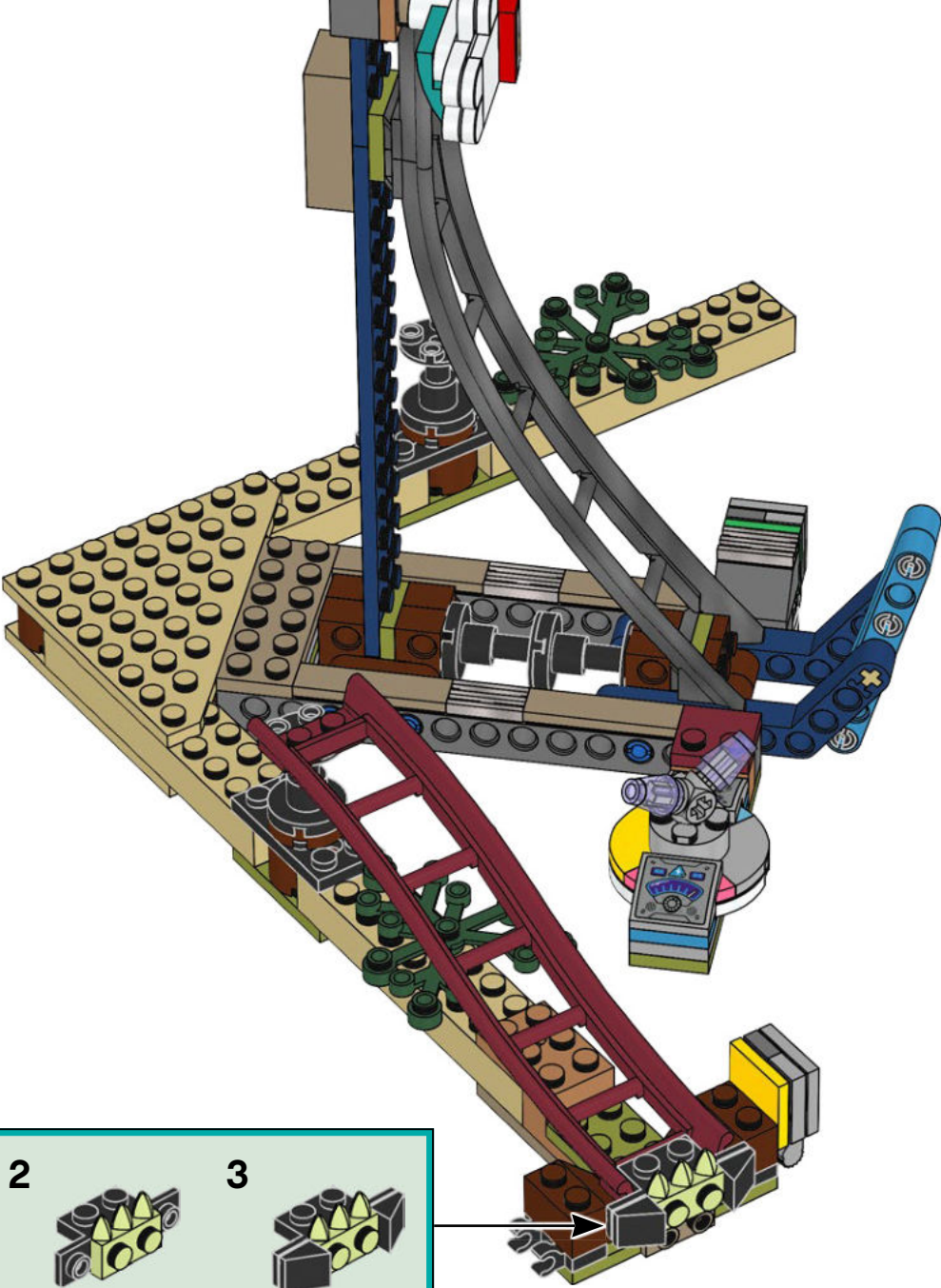



96

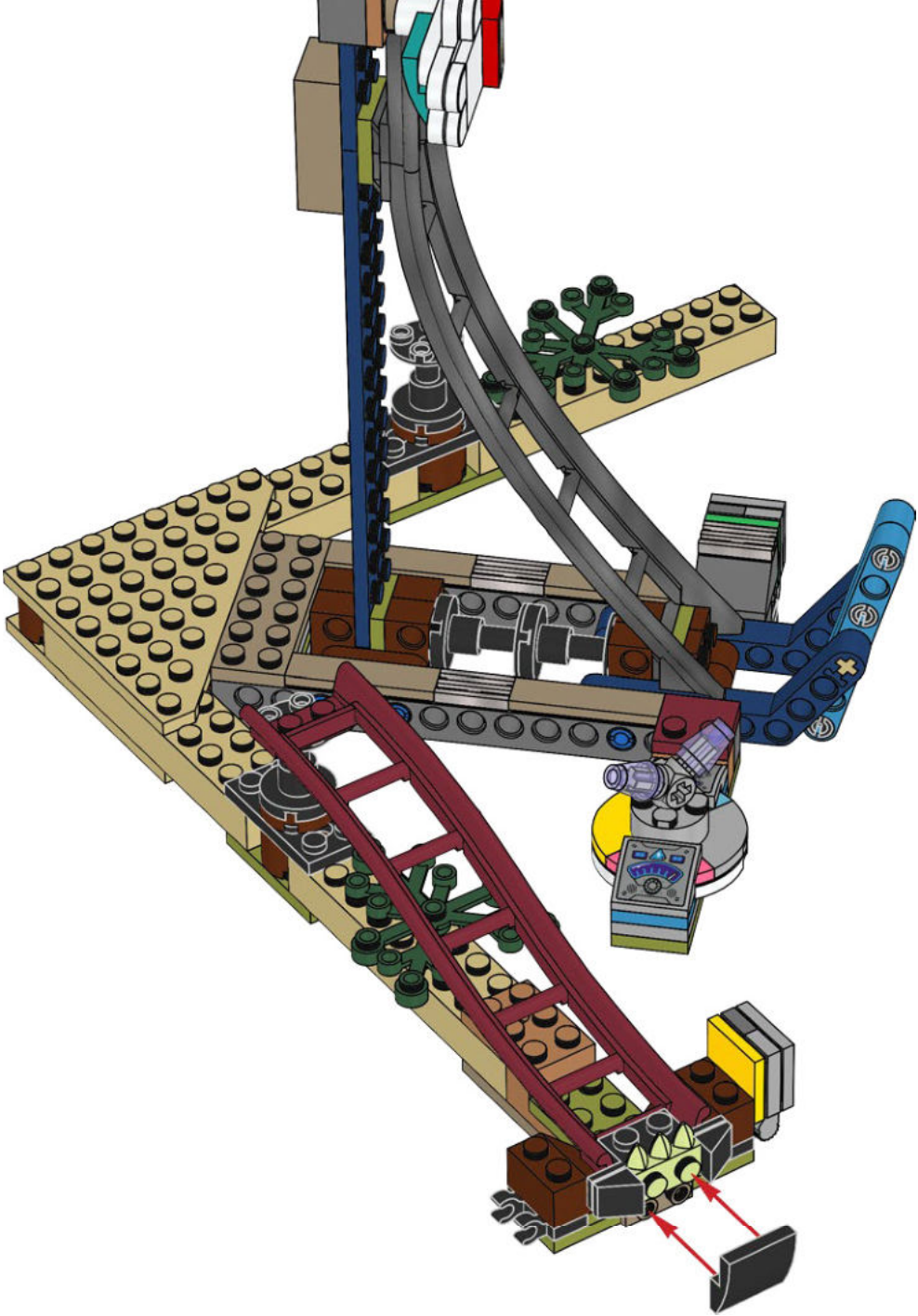

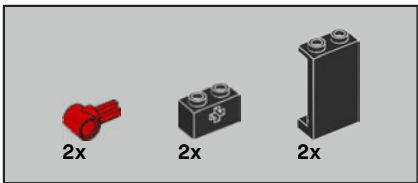

97

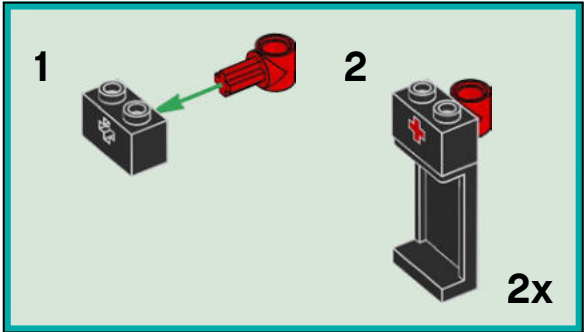
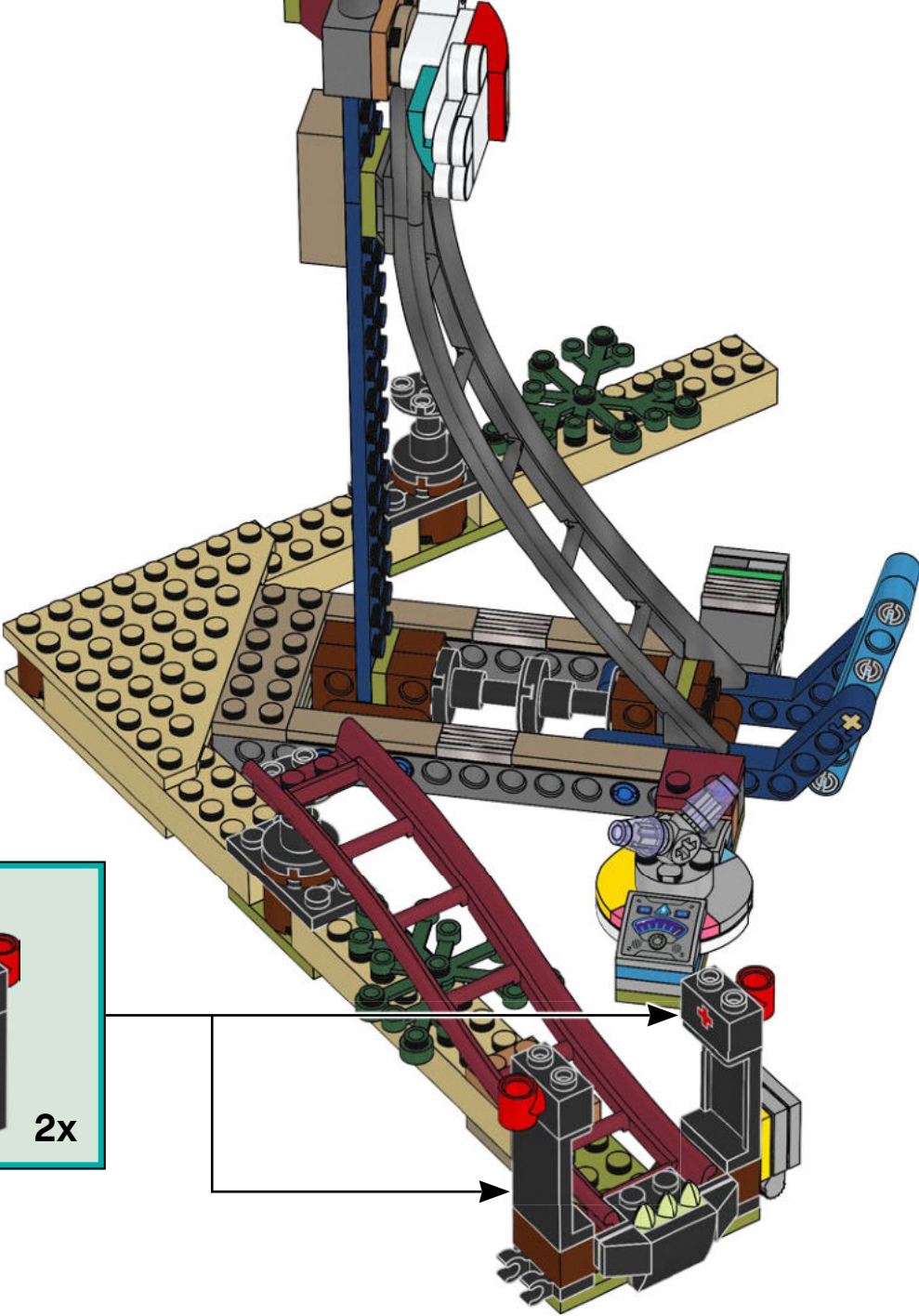



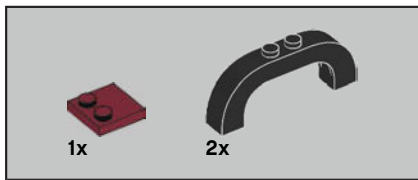

98

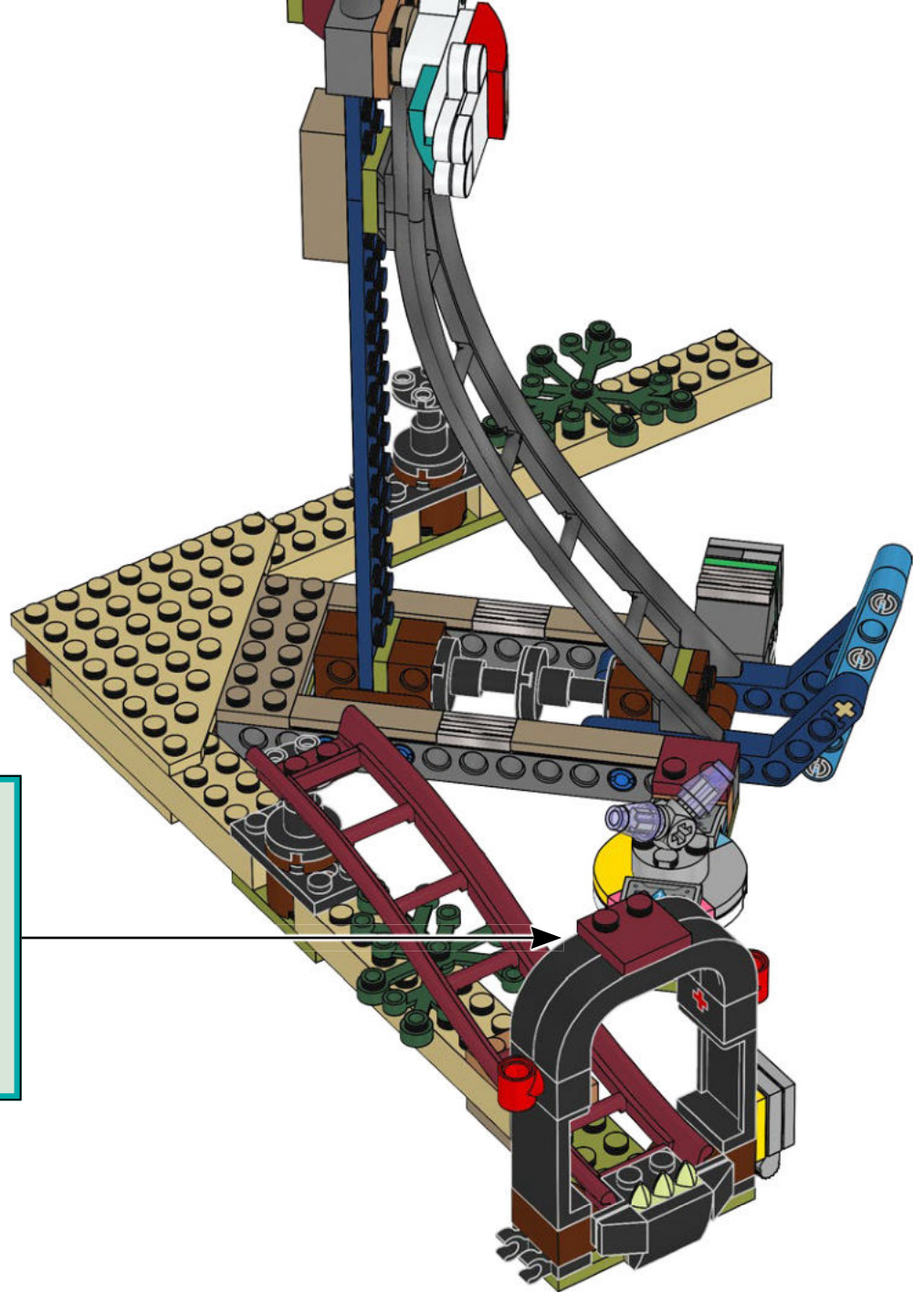
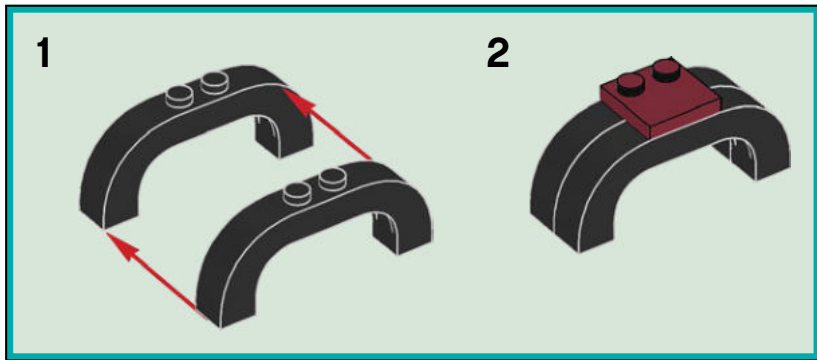

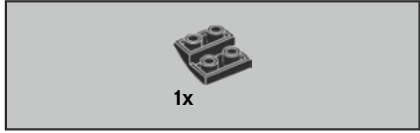
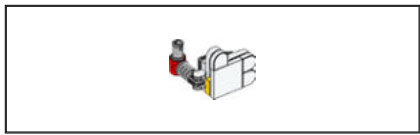

99

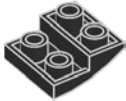

100



101



102



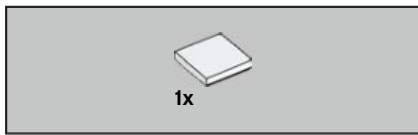

103



104



105

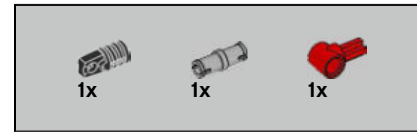
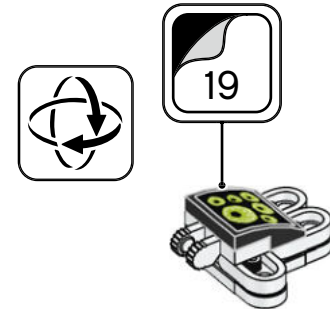

106

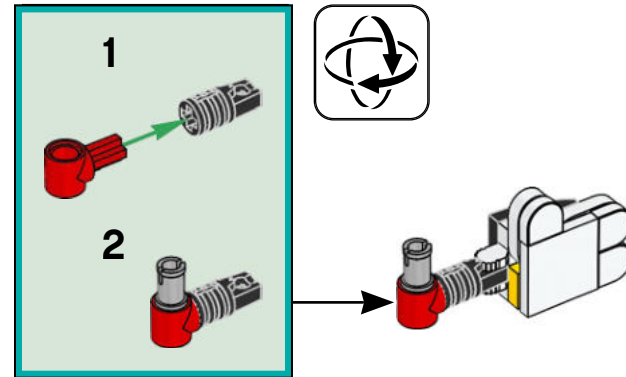

107

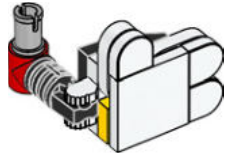

108

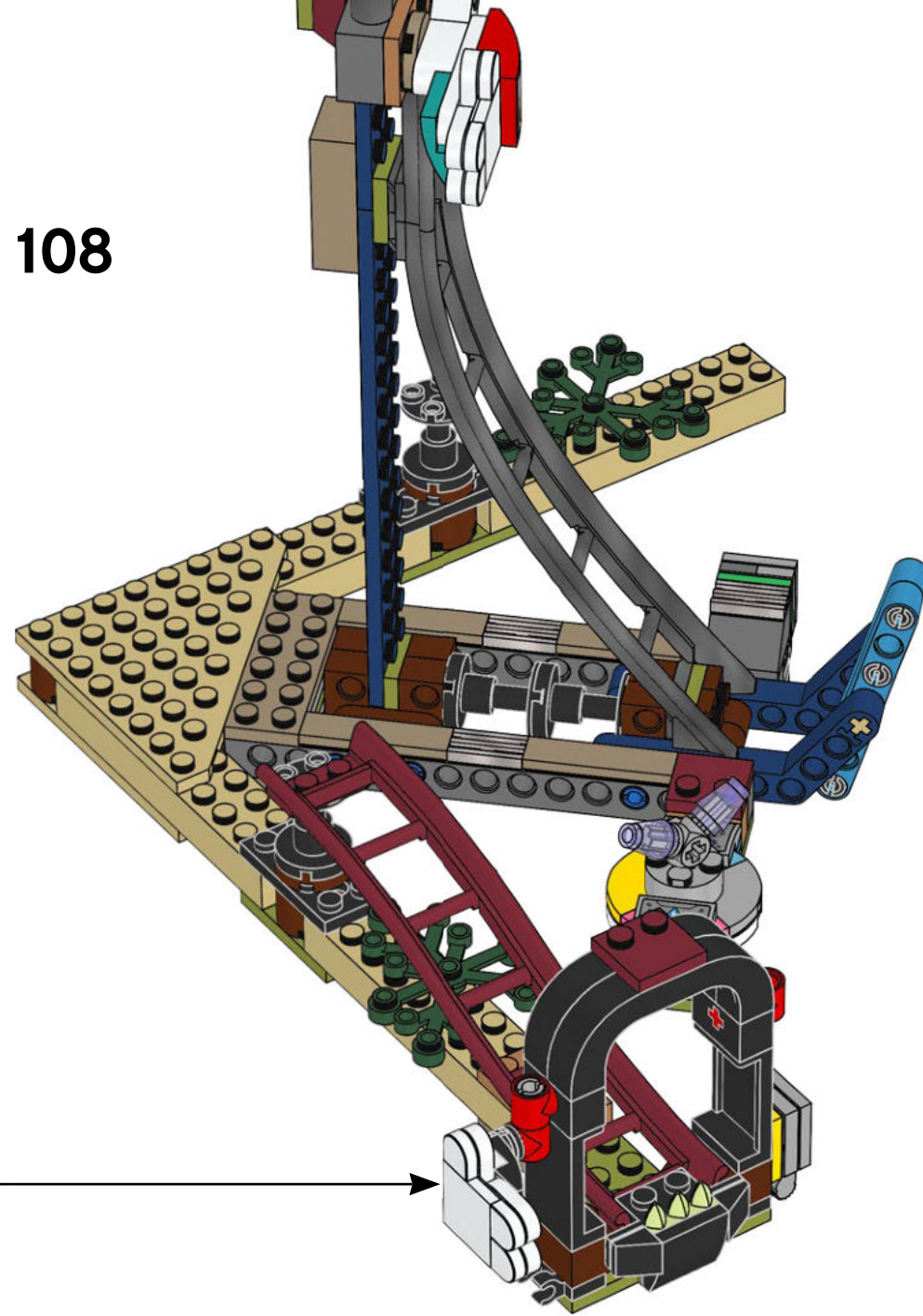

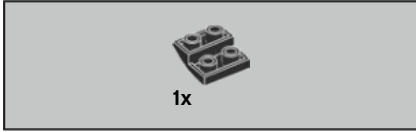

**109**



**110**

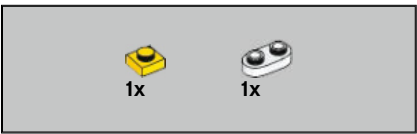

**111**



**112**



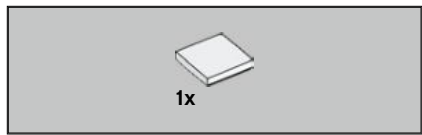

113



114



115

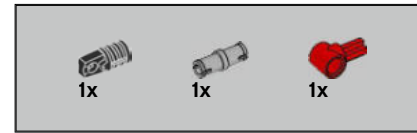
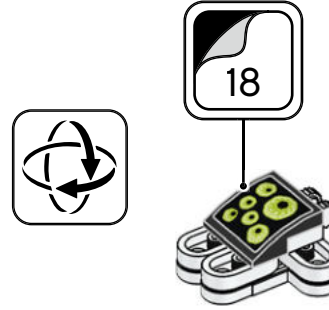

116

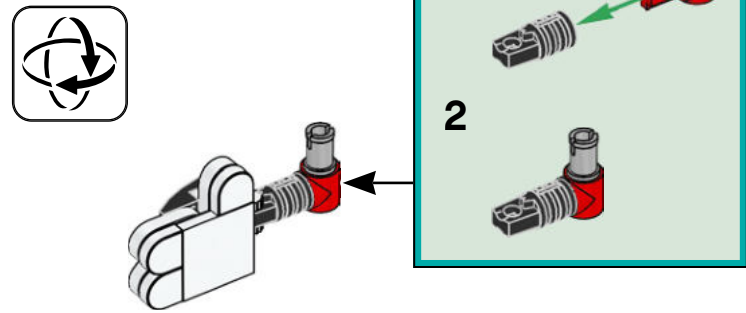

117



118

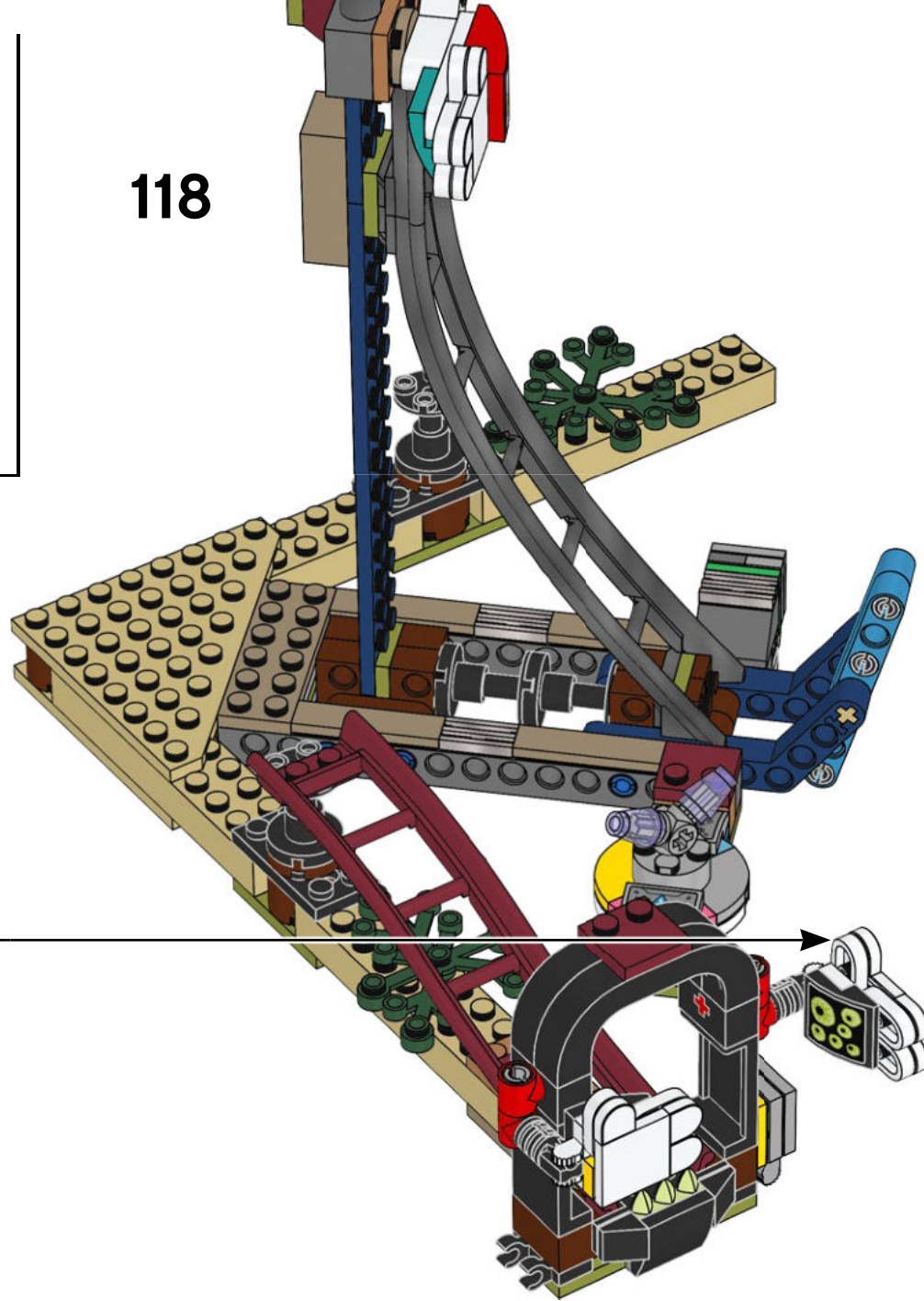

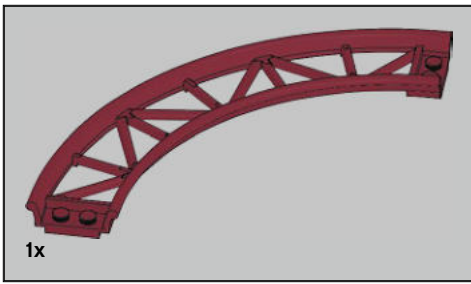

119

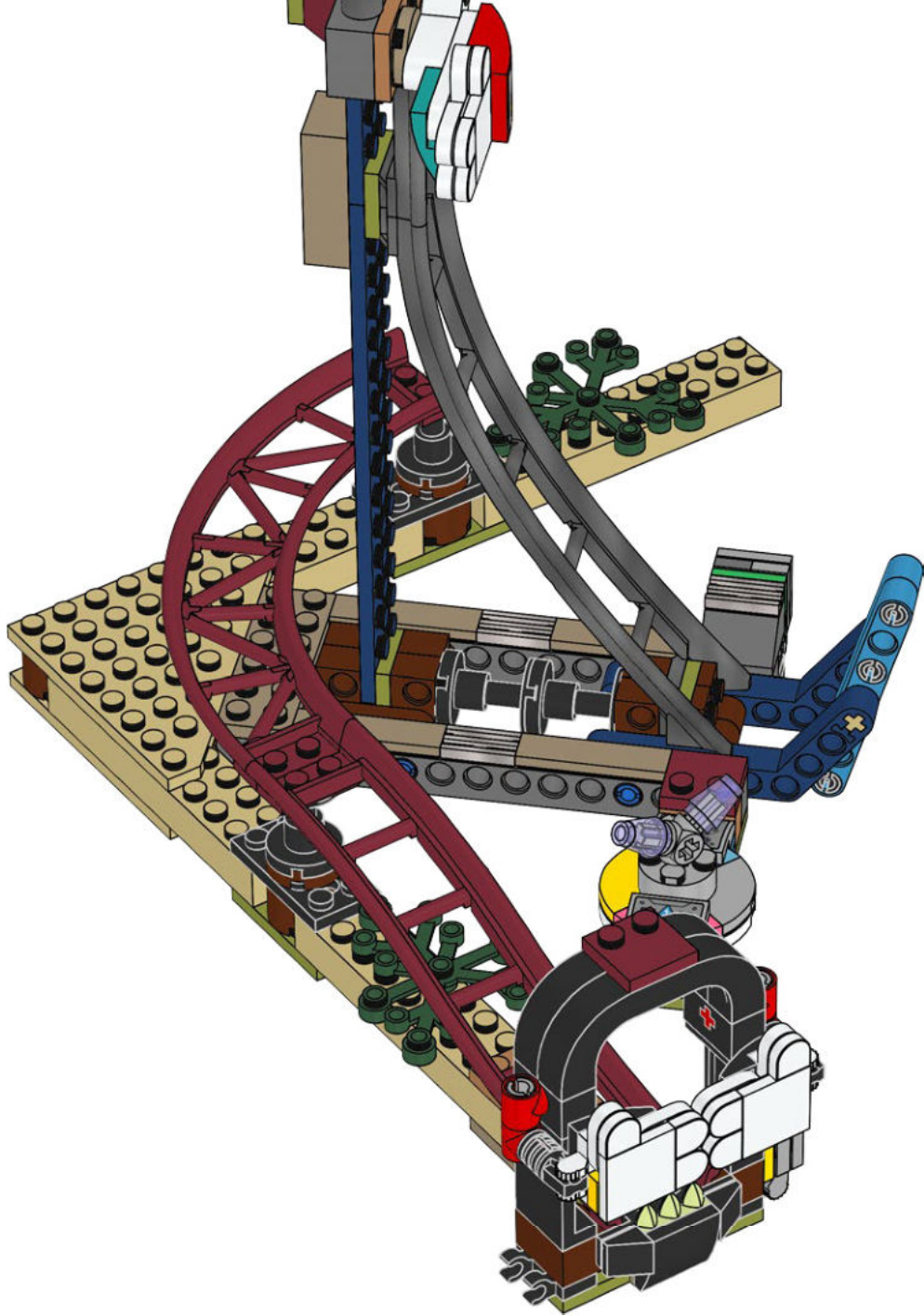



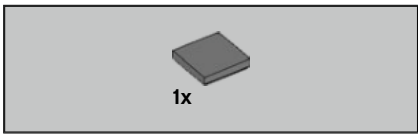

120

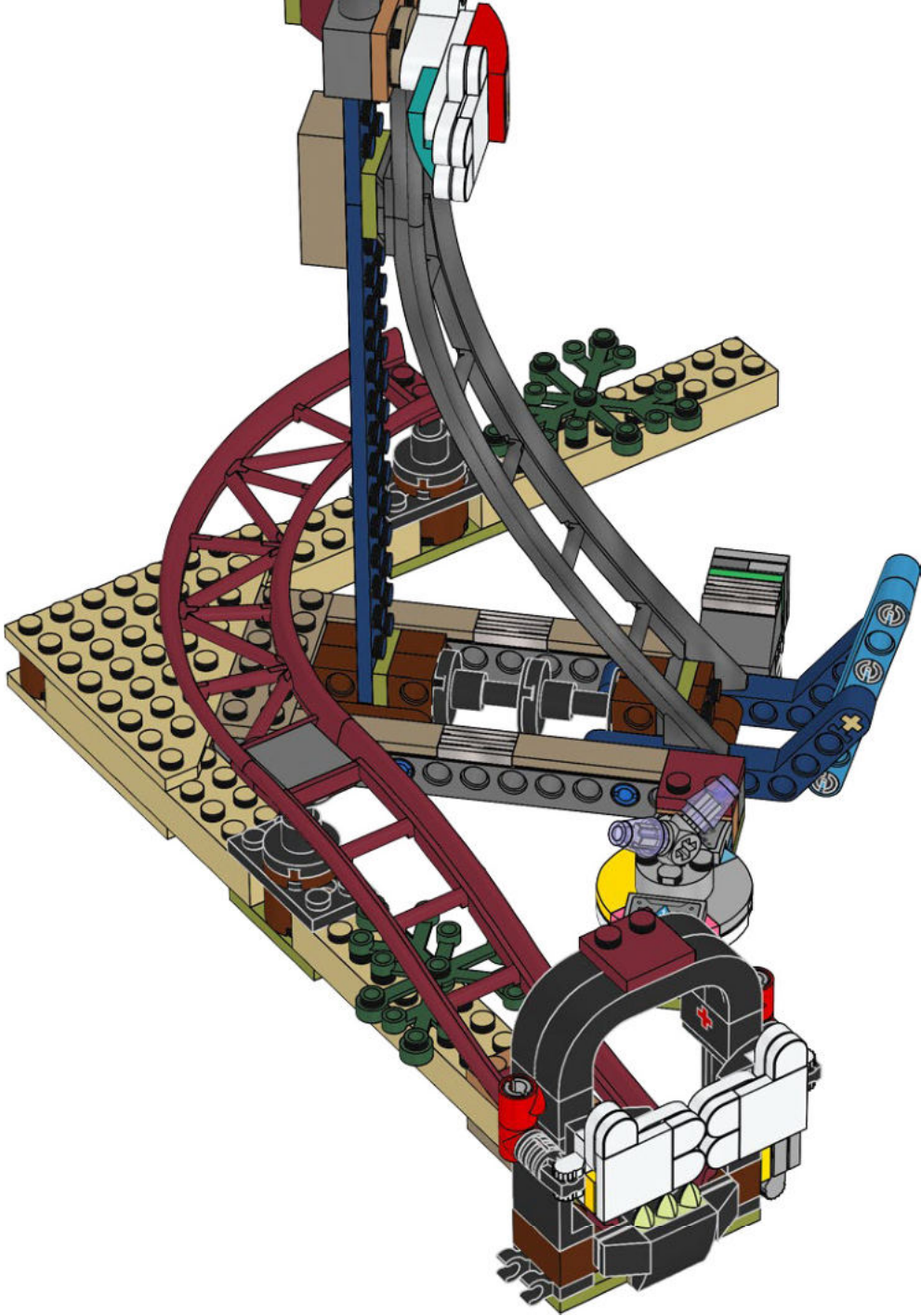

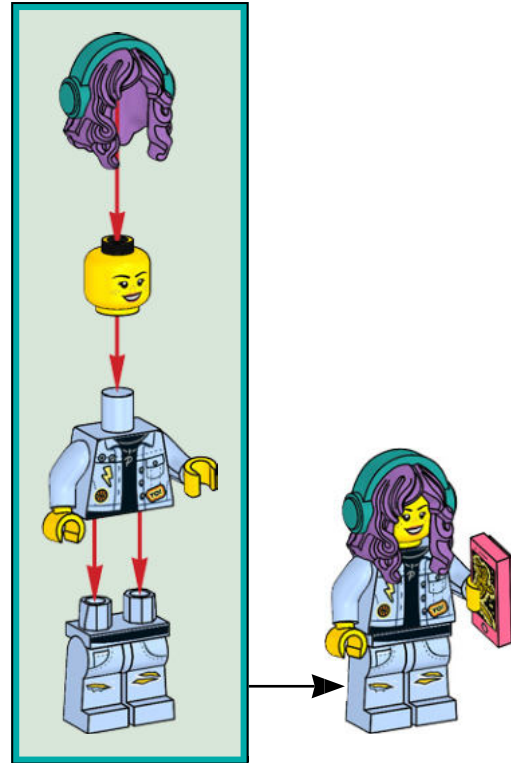
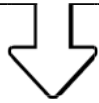
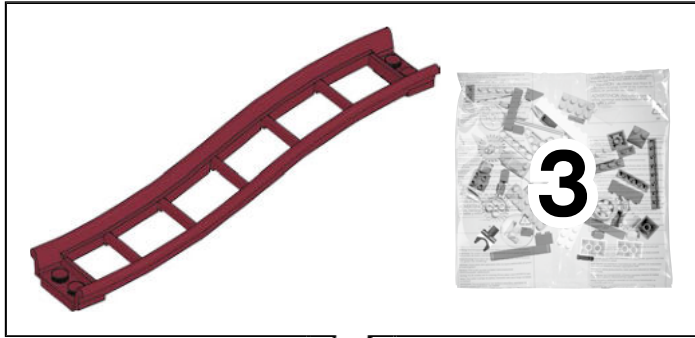

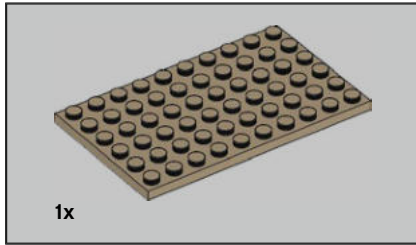
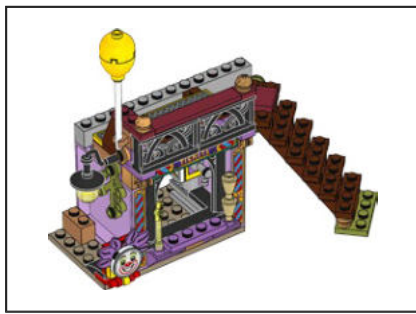

121

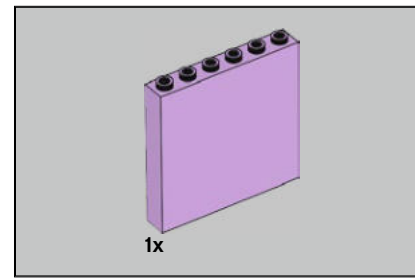
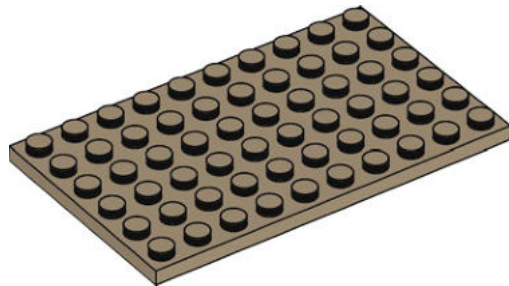

122

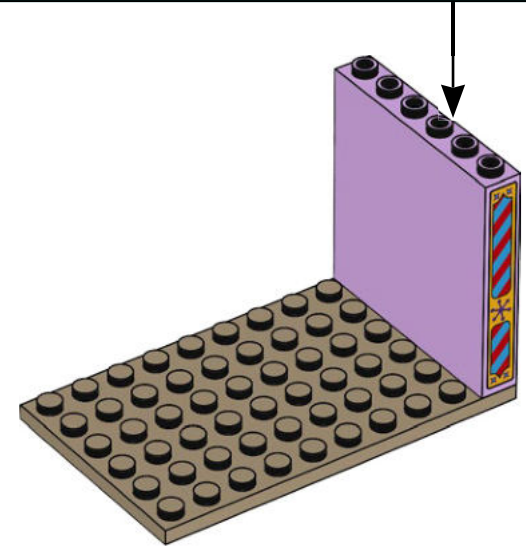
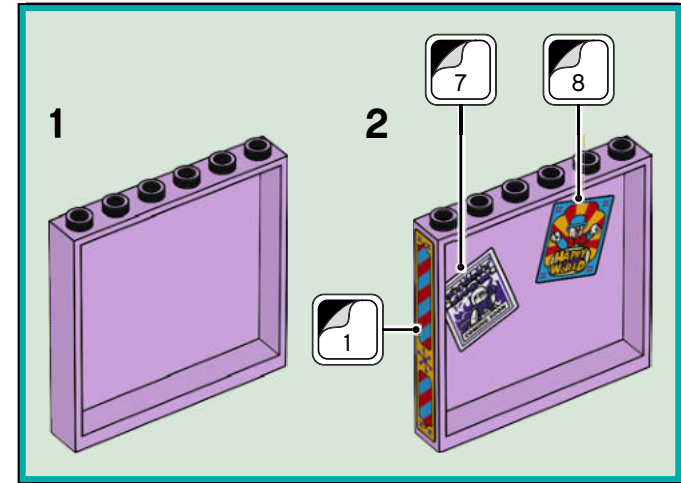

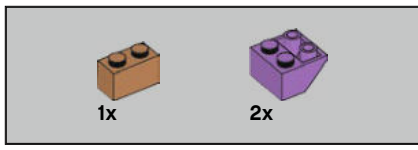

123

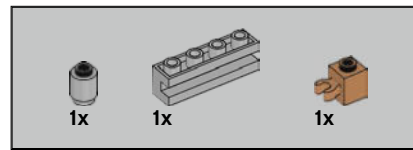
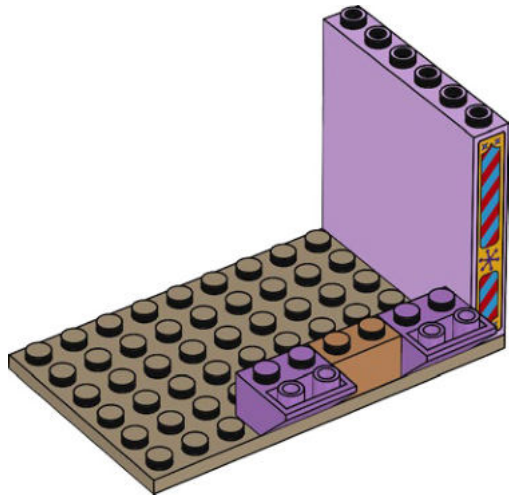

124

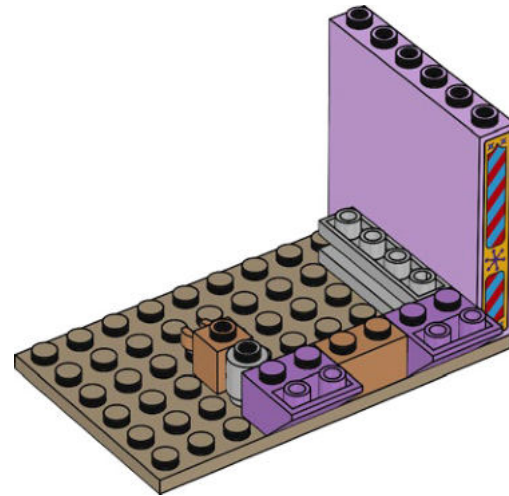

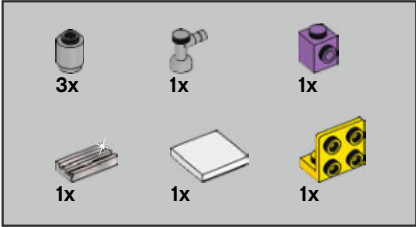

# 125

1



2



3

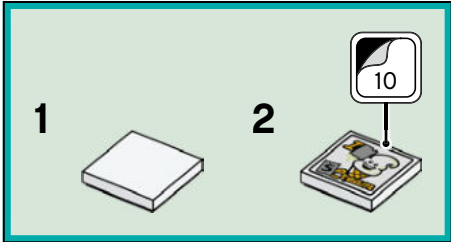

4



5



6

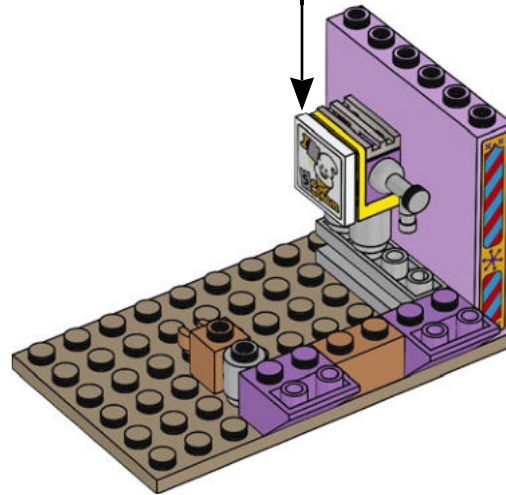

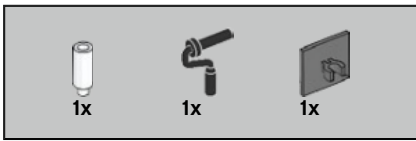

# 126

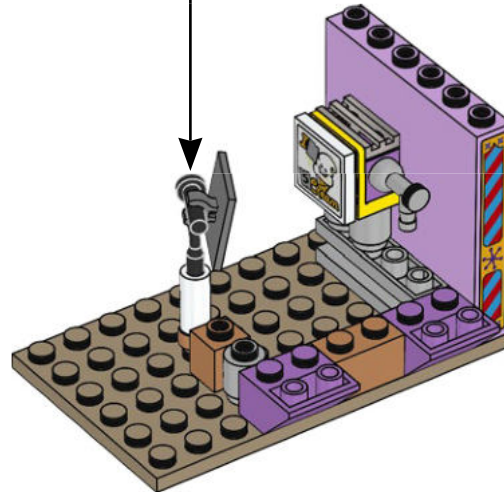
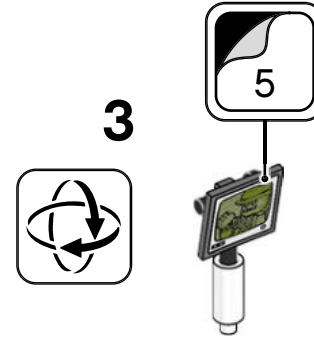
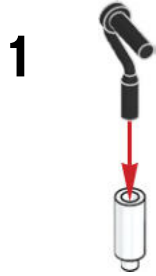

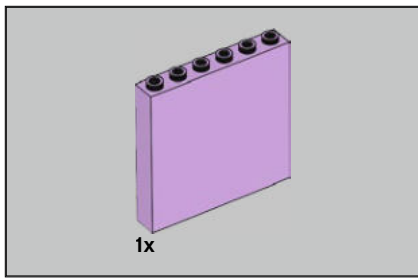

127

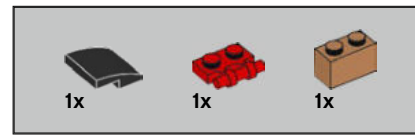
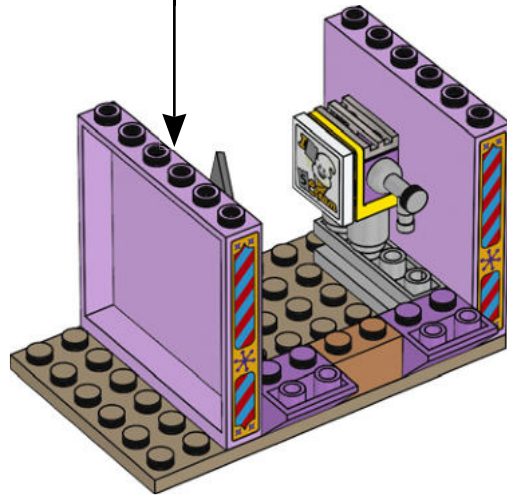
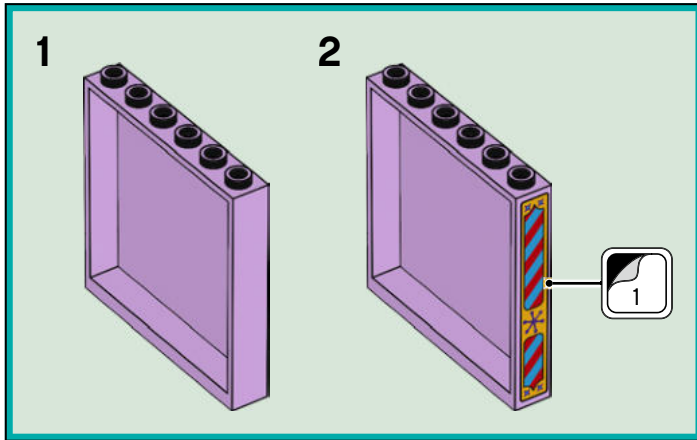

128

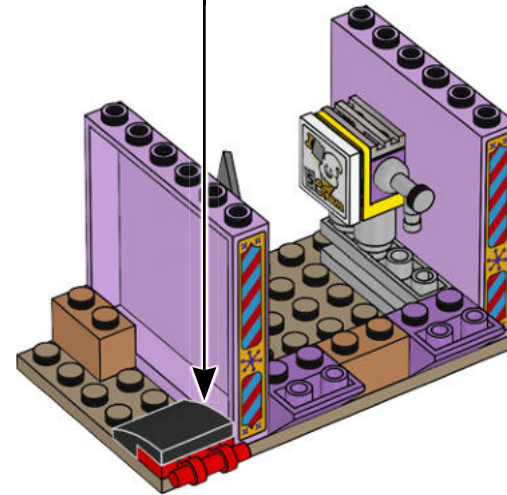
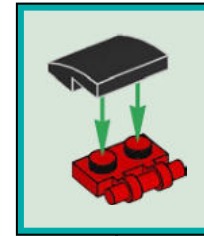



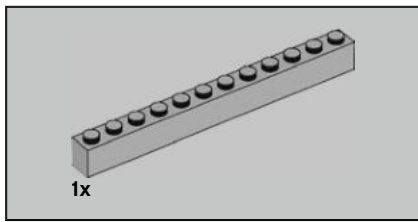

129

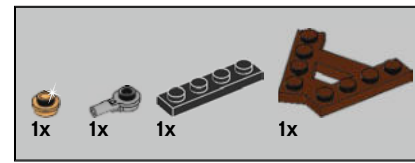
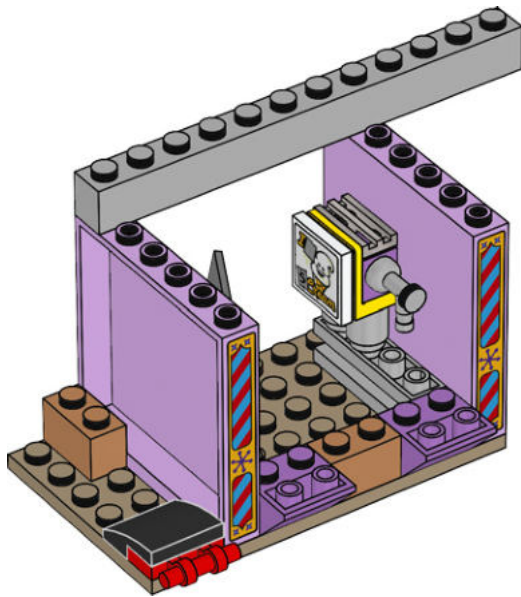

130

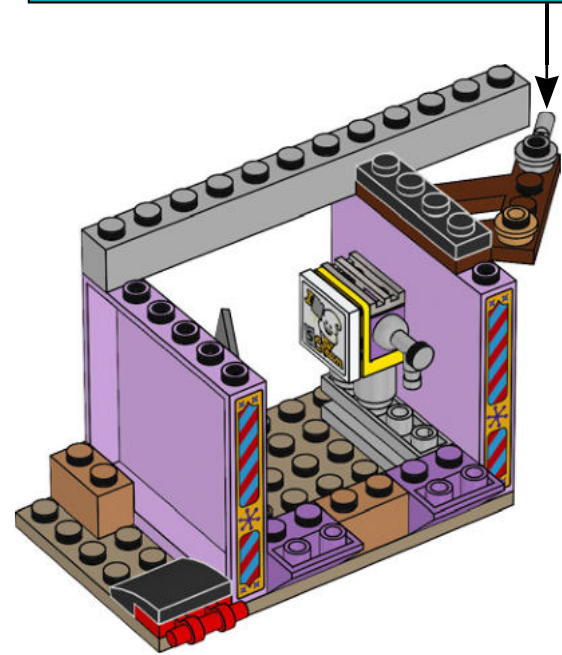

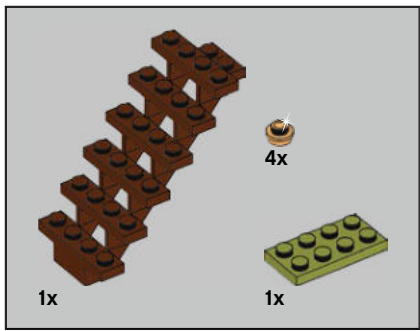

131

1

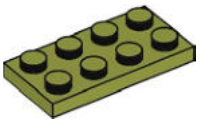

2

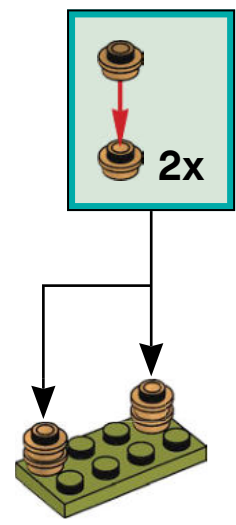

3

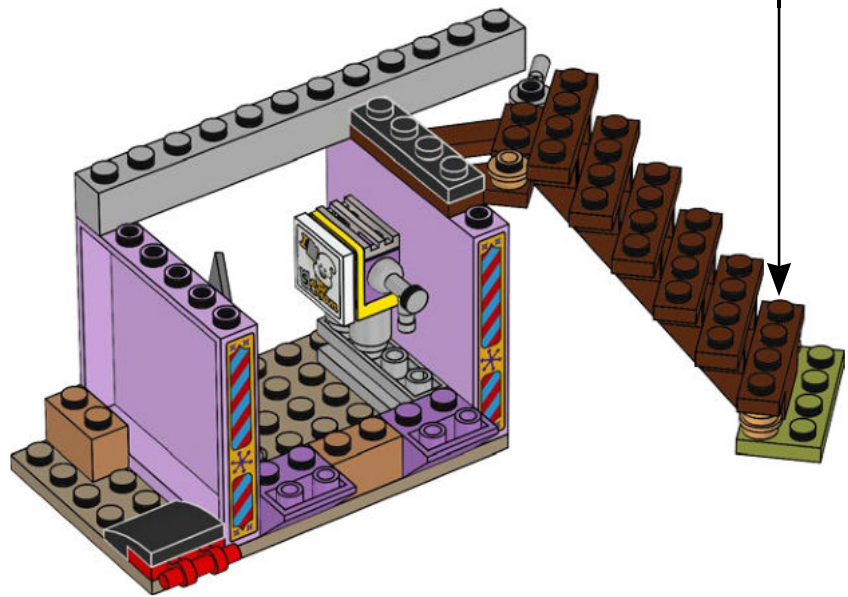
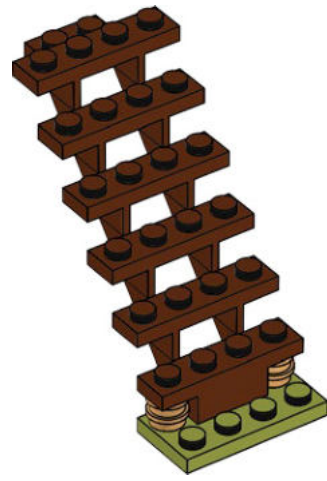

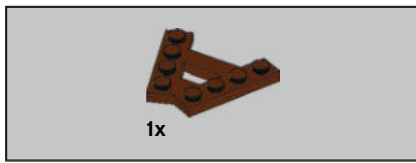

132

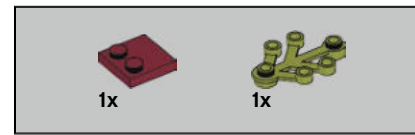
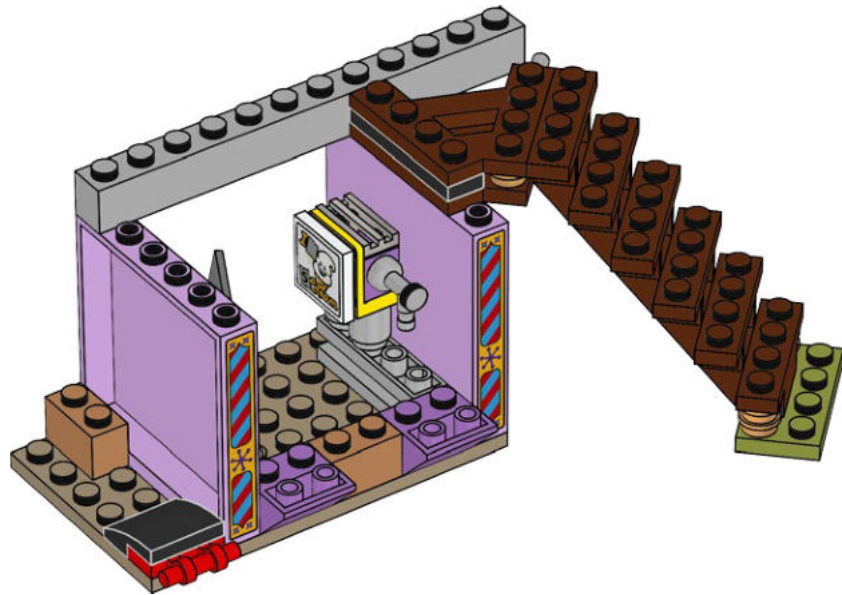

133

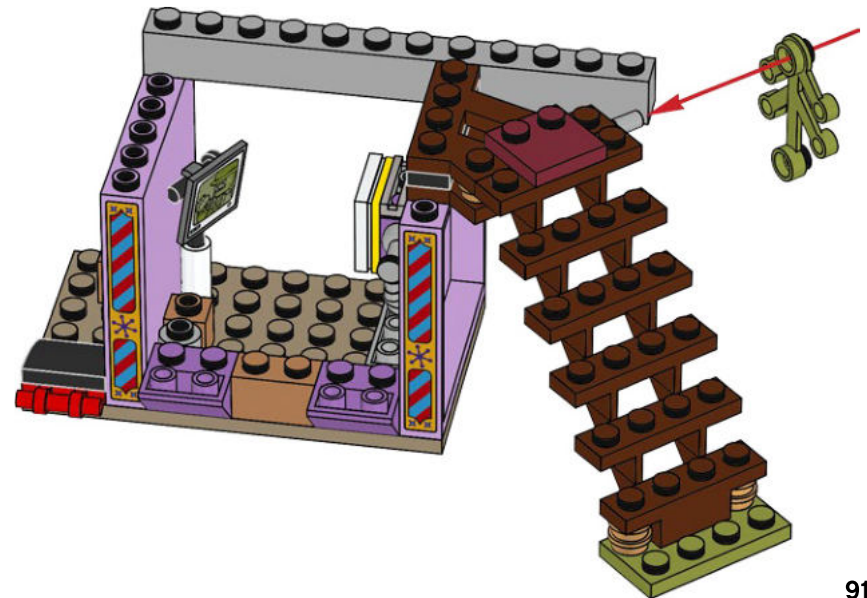

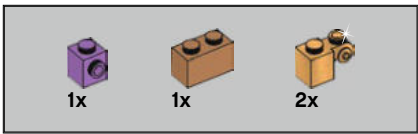

134

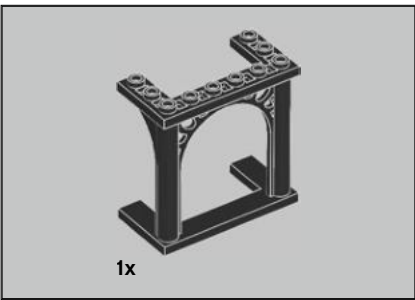
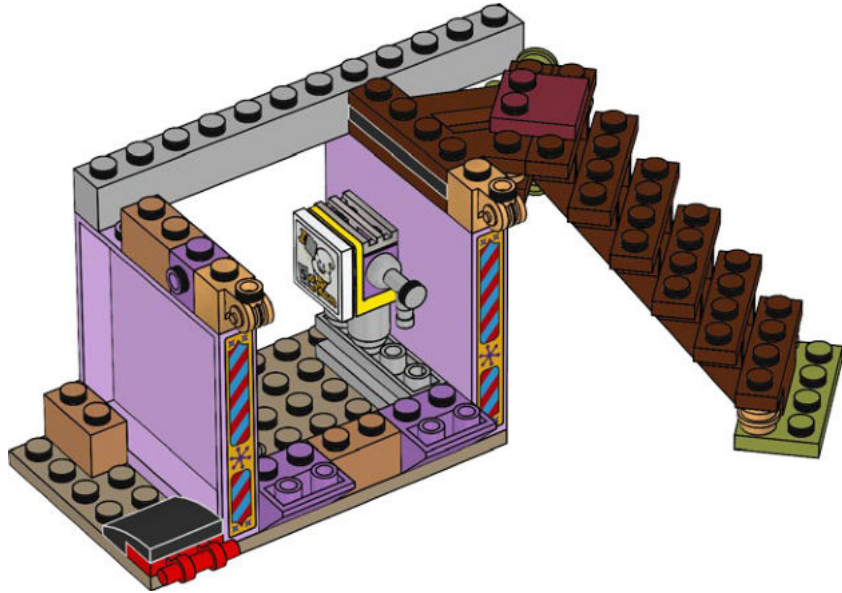

135

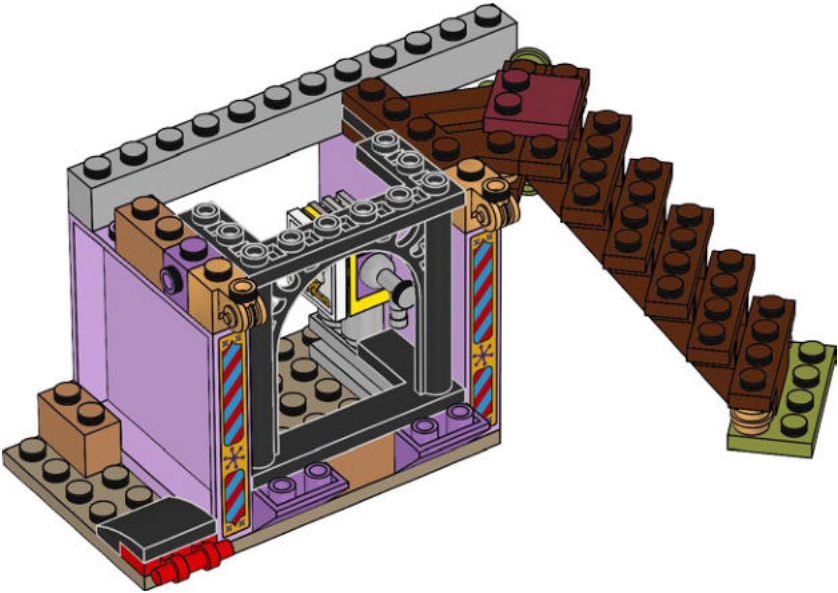

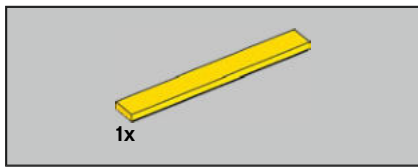

136

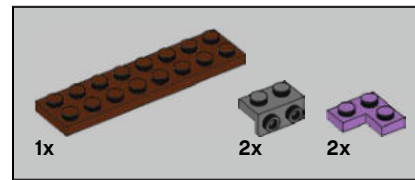
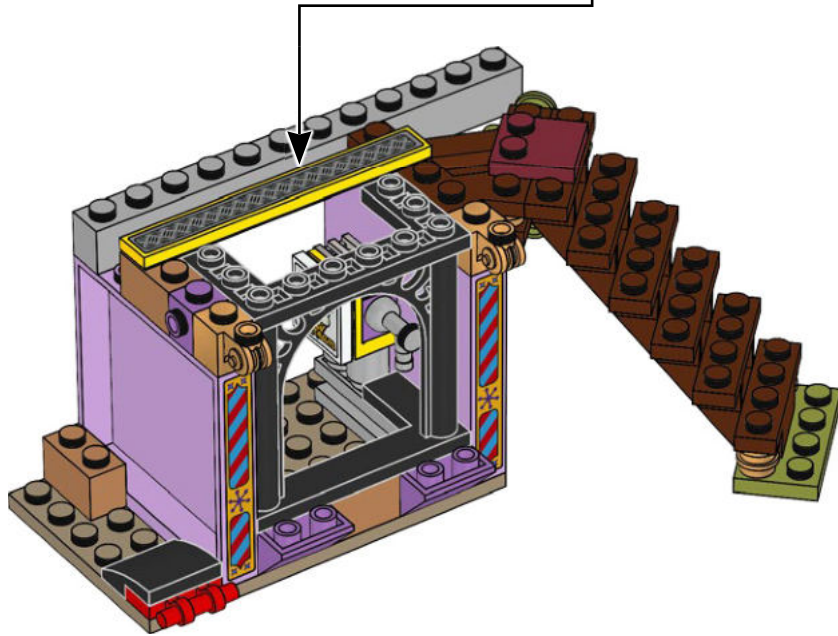
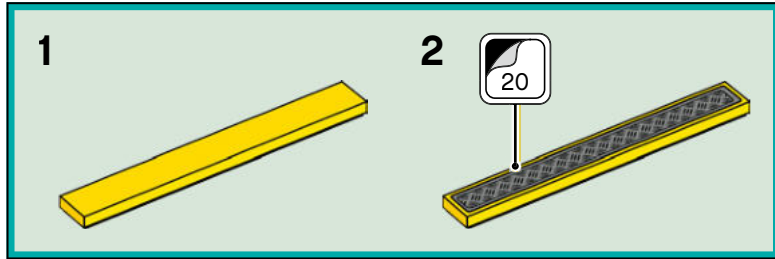

137

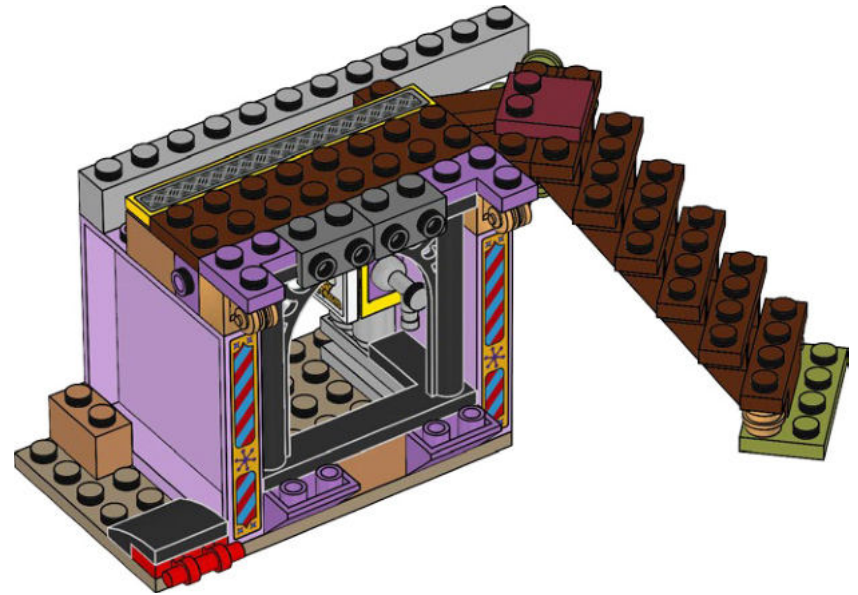

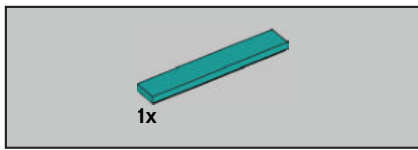

138

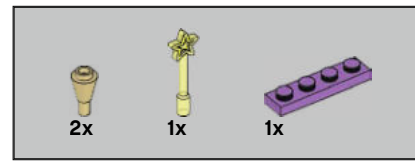
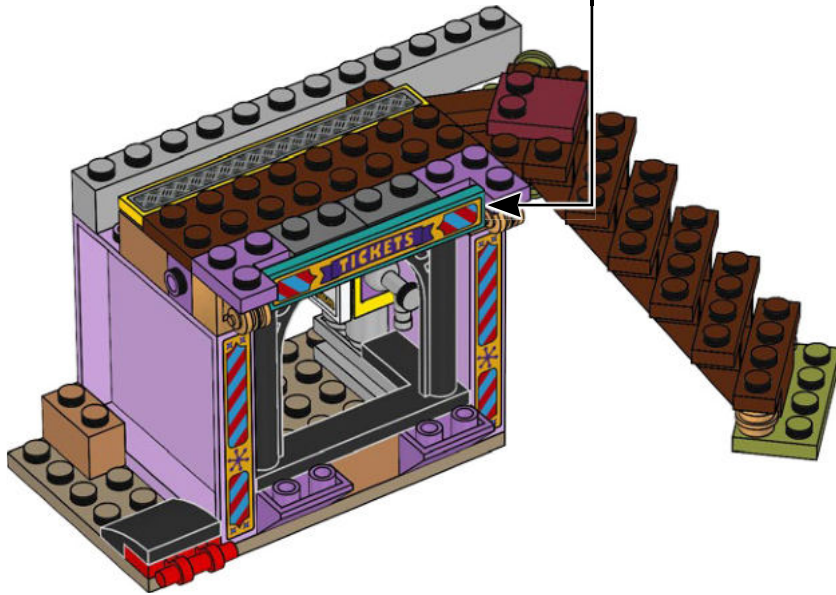
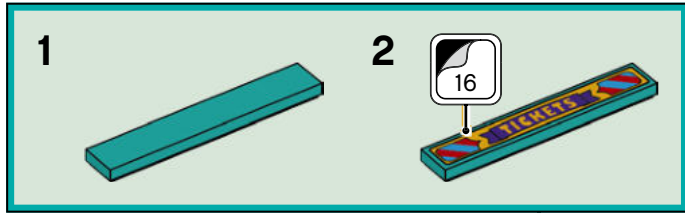

139

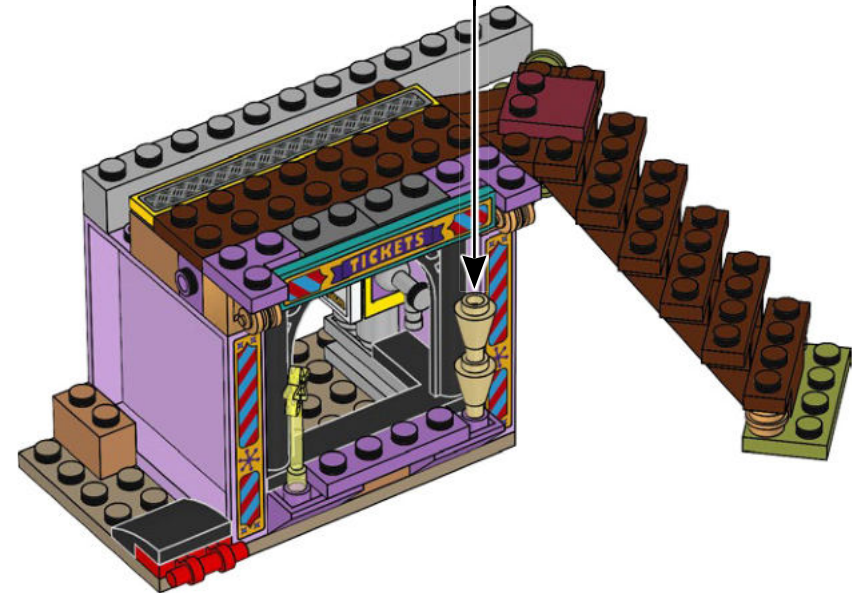
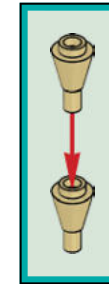

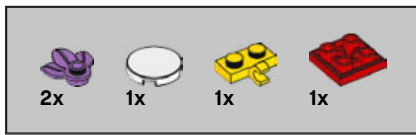

140

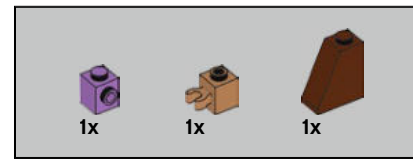
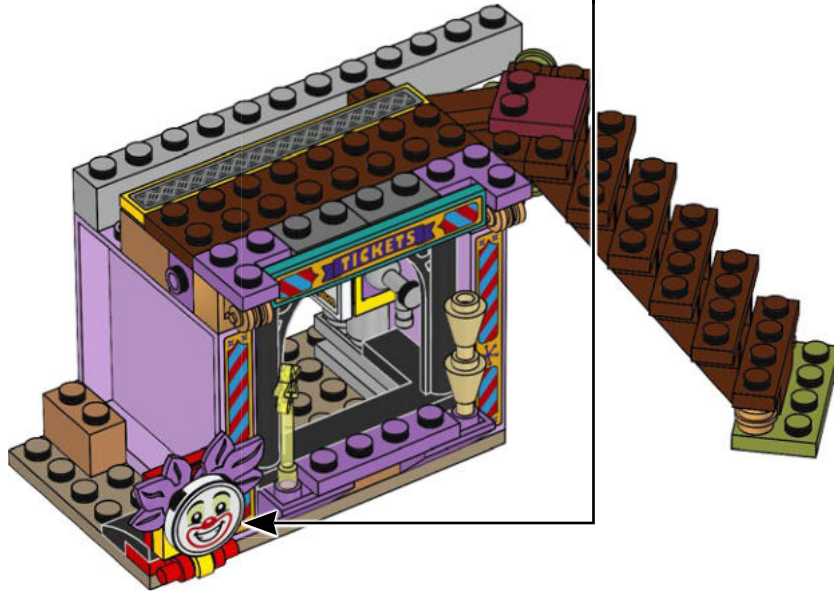
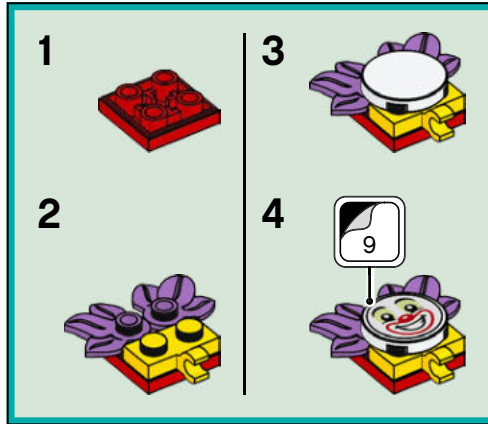

141

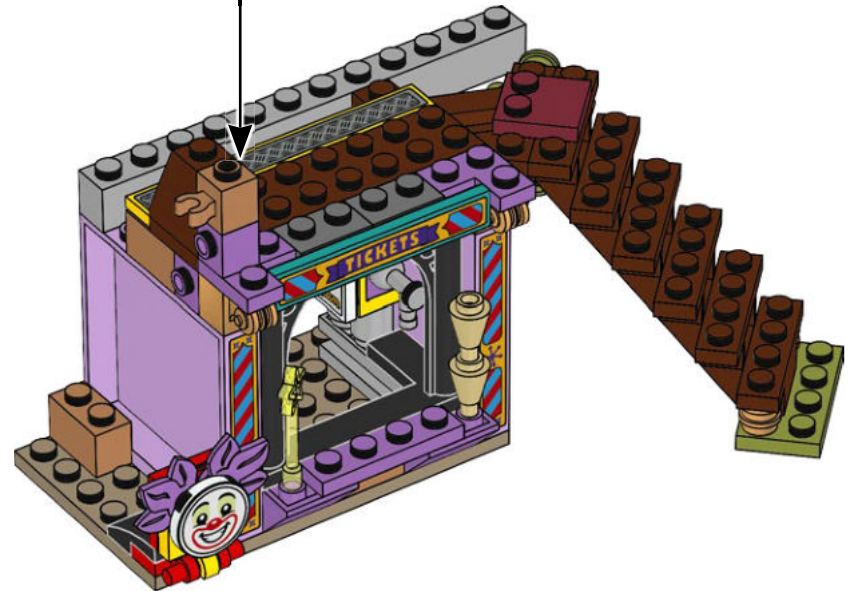
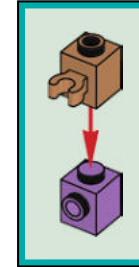

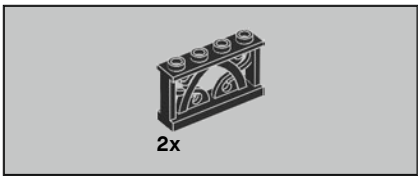

142

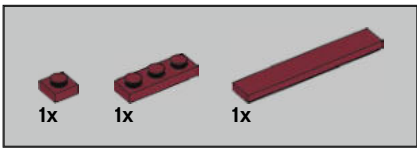
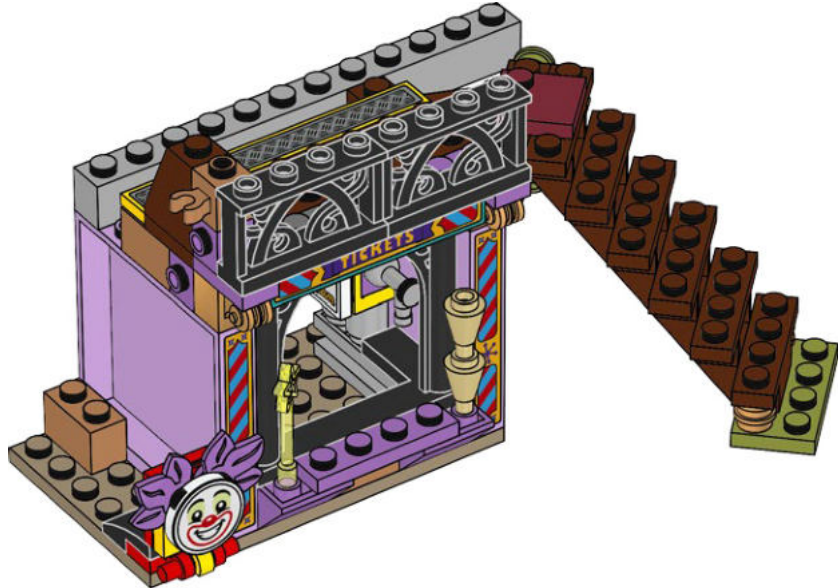

143

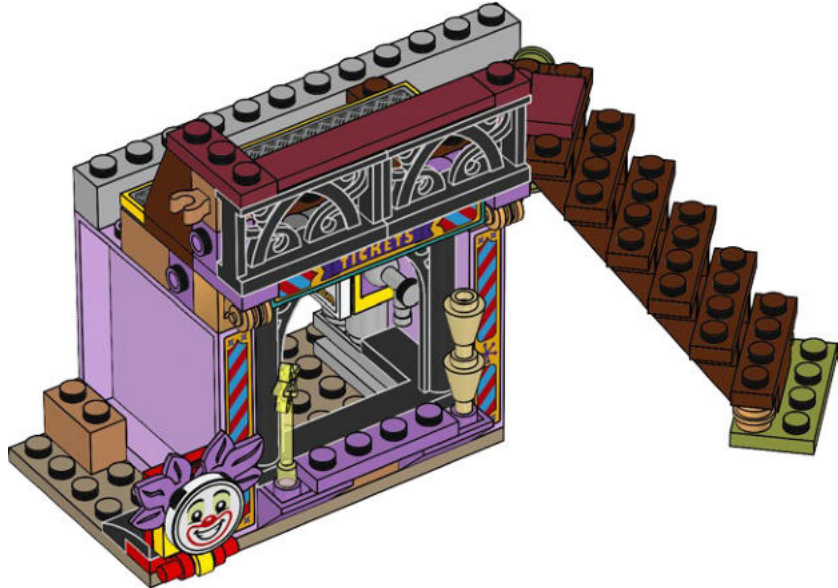



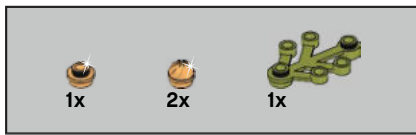

144

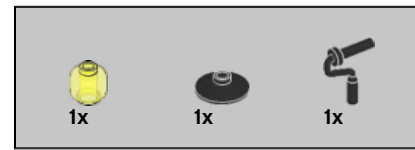
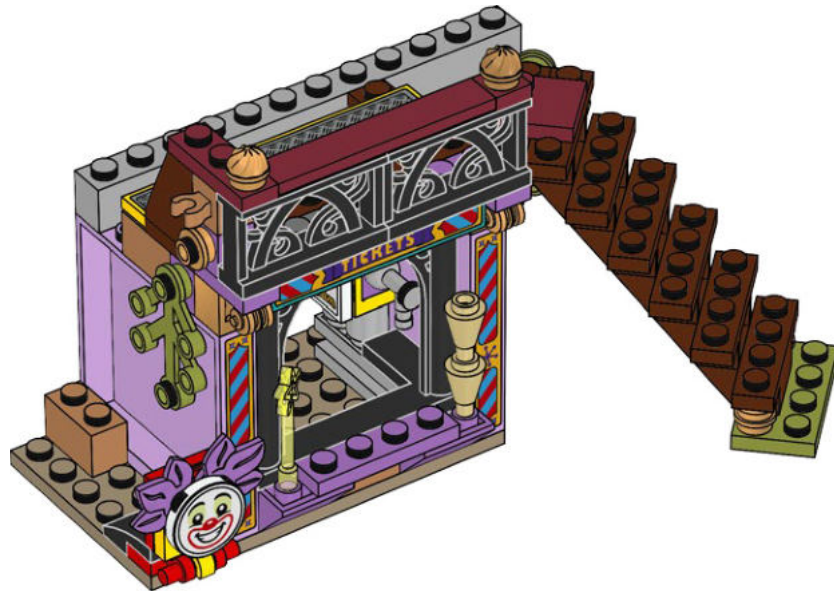

145

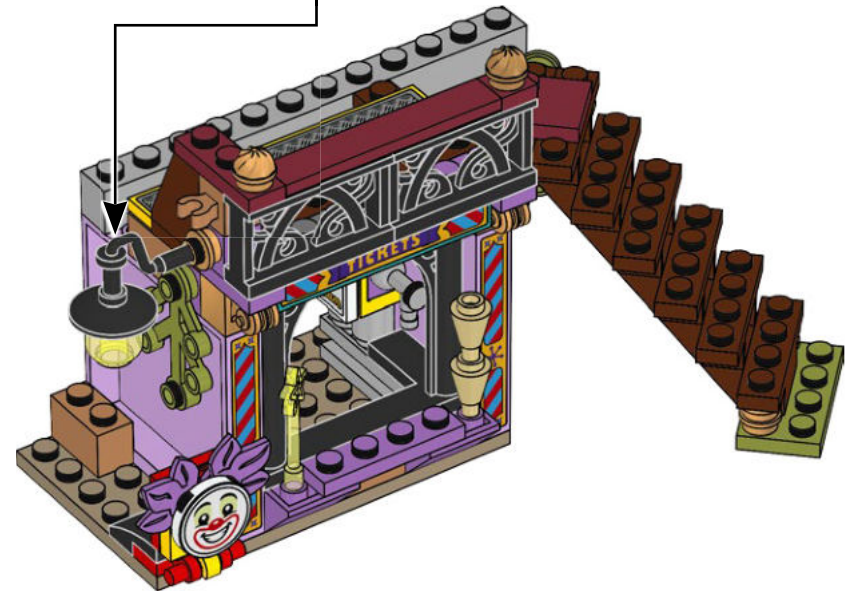
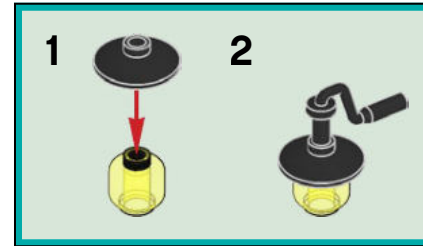

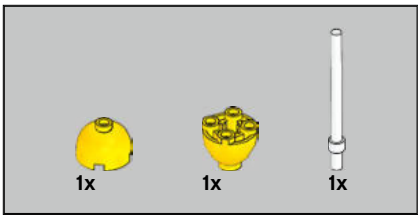

146

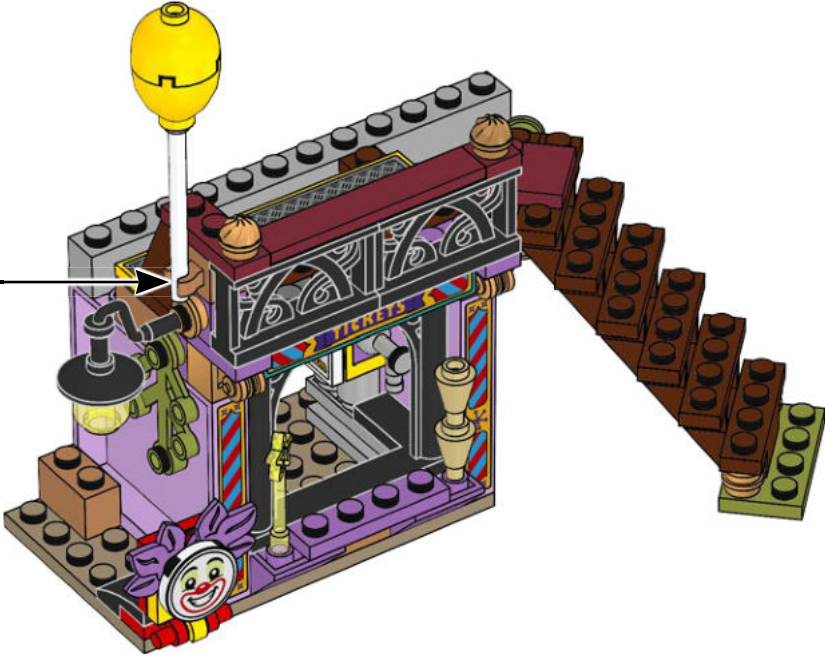
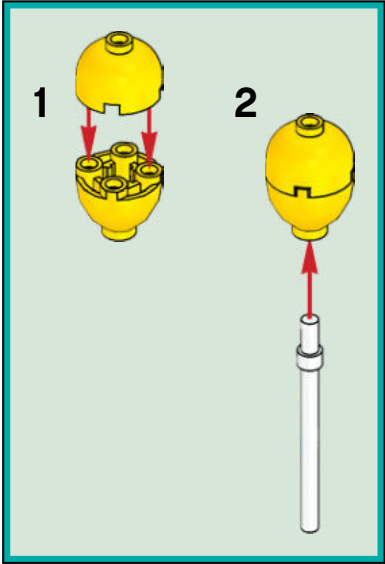

147

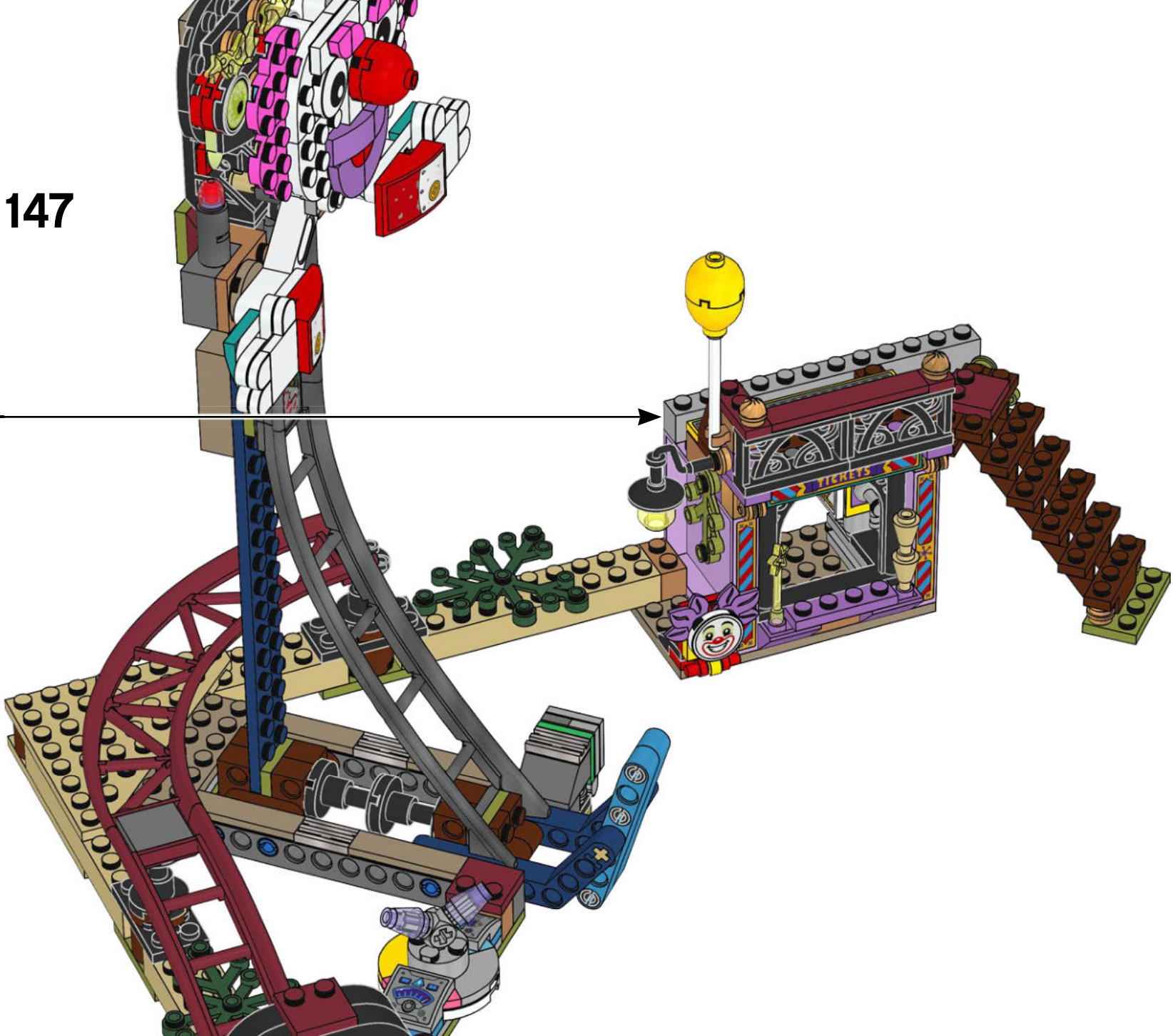

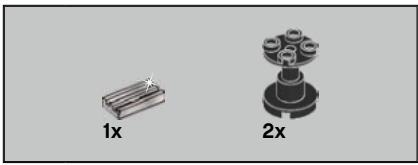

148

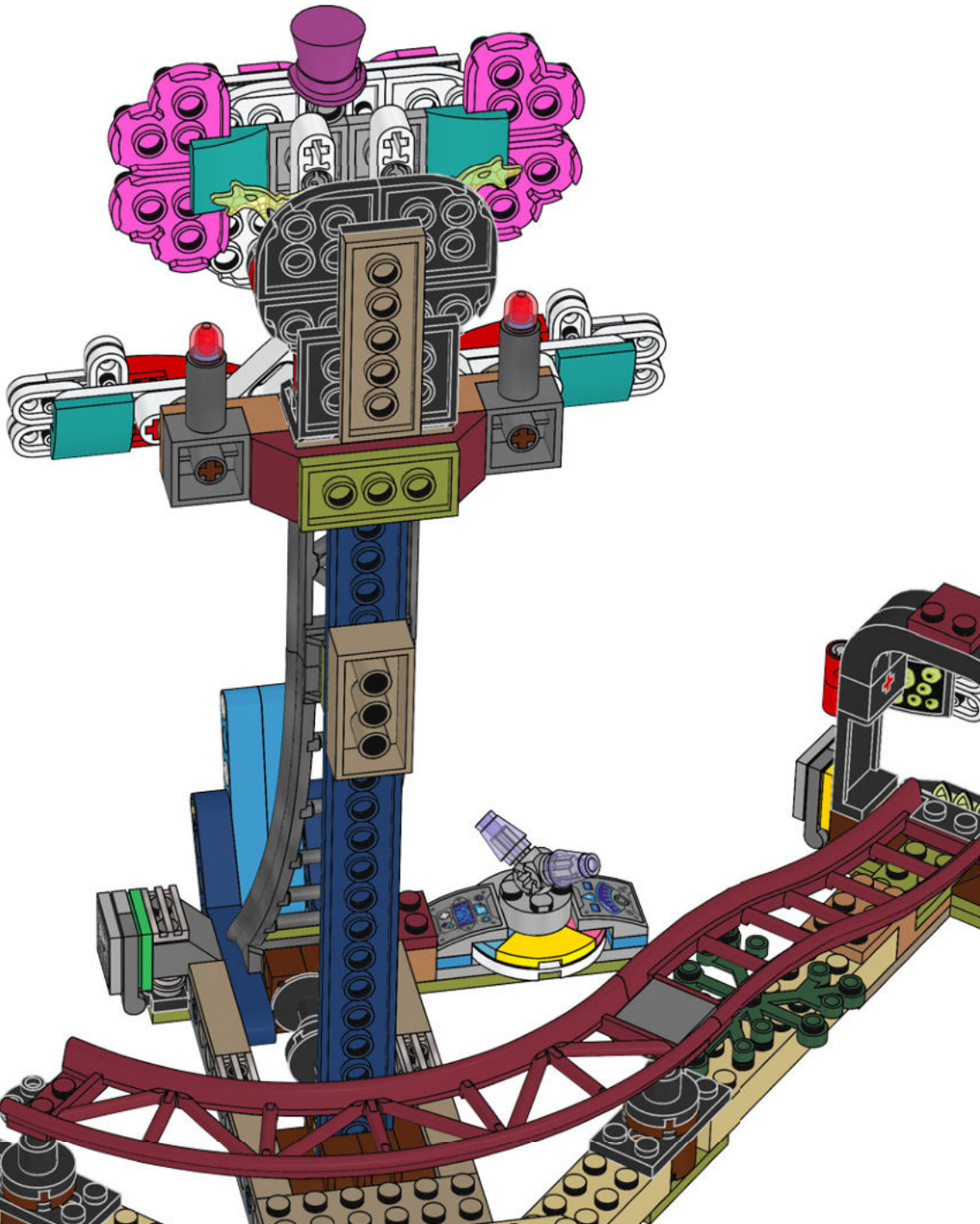
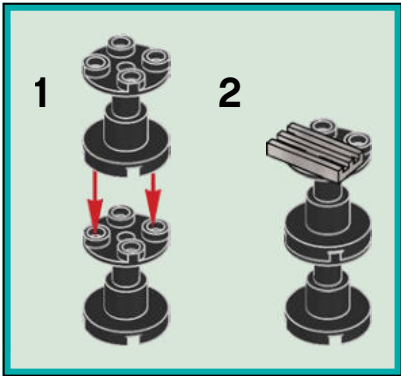
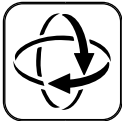

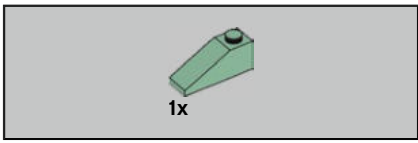

149

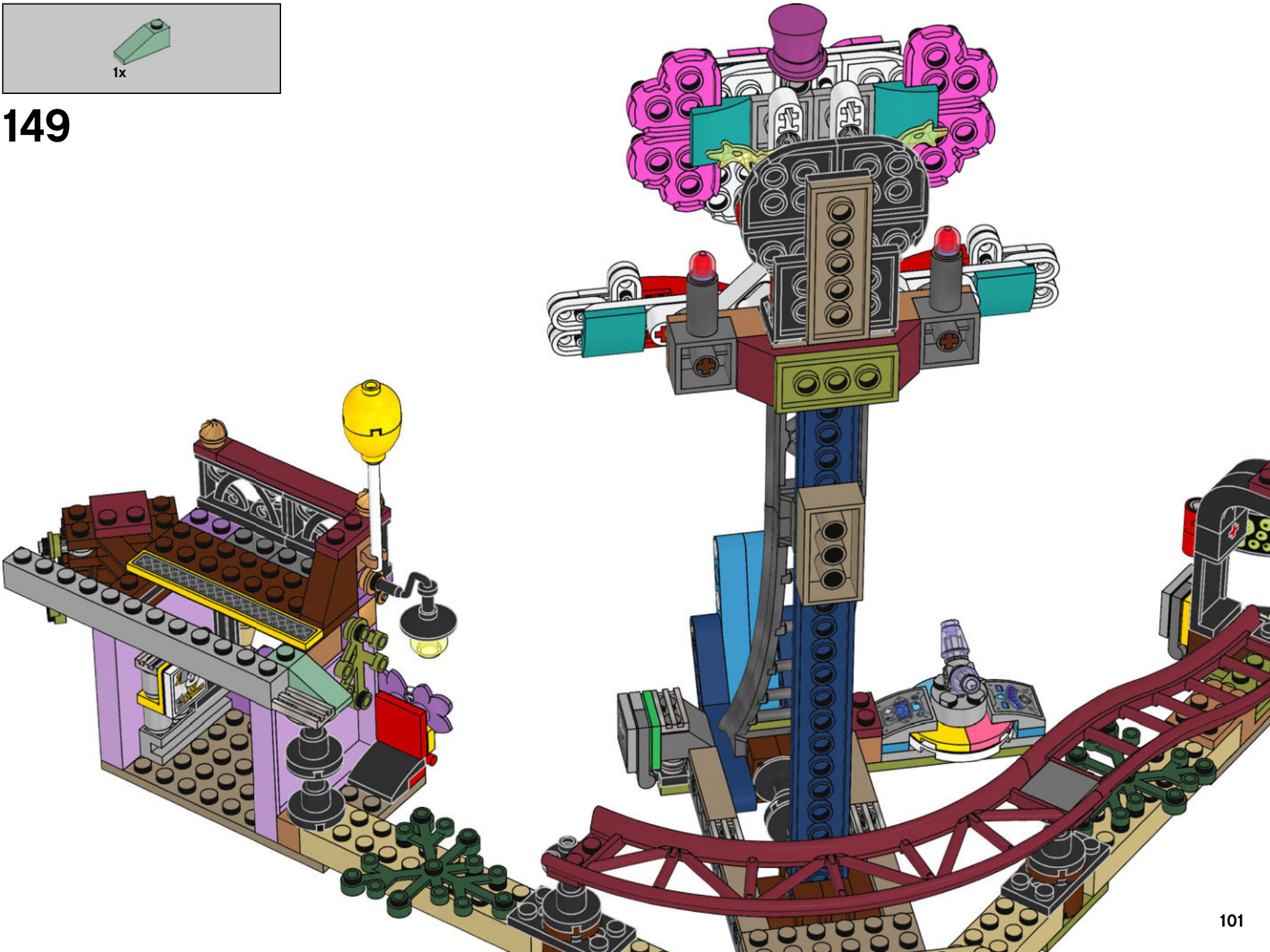

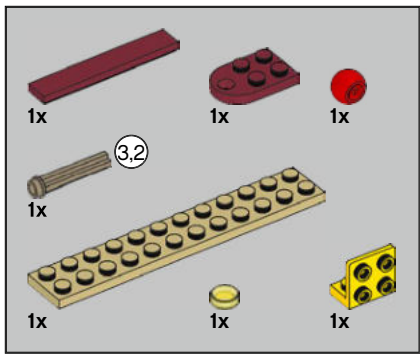

150

1

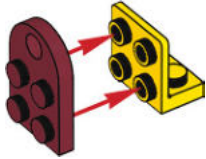

2

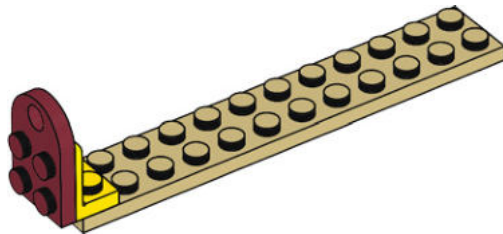

3

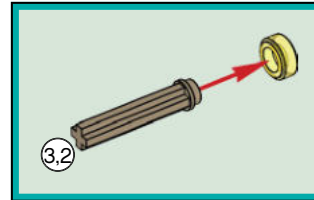
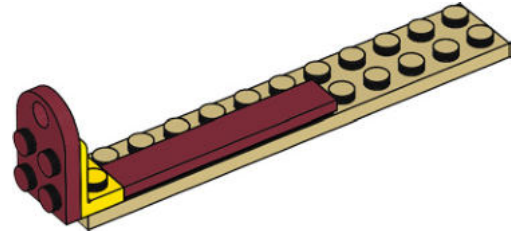

3

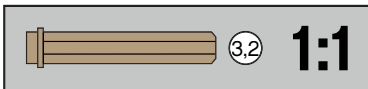
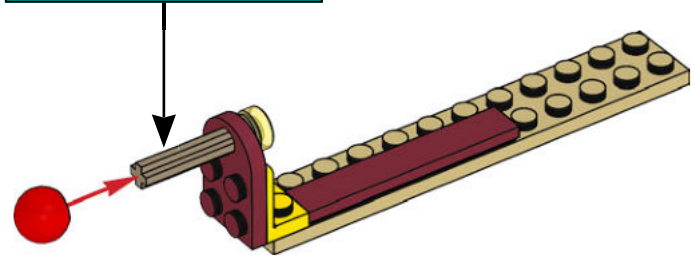



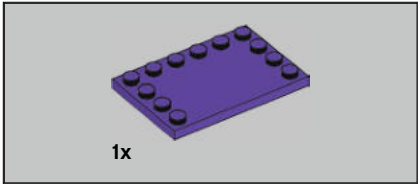

1x

151

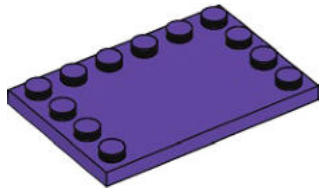

152

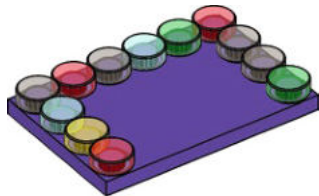

153

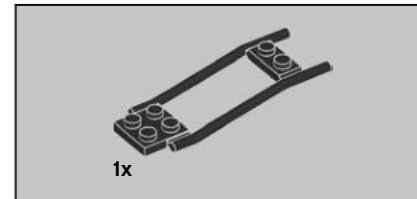

1x

154





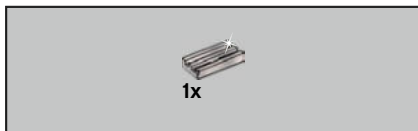

155

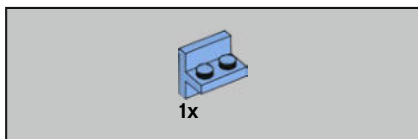

156

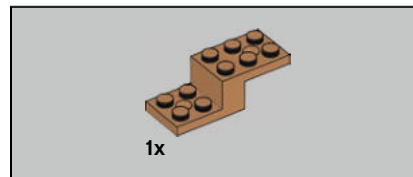
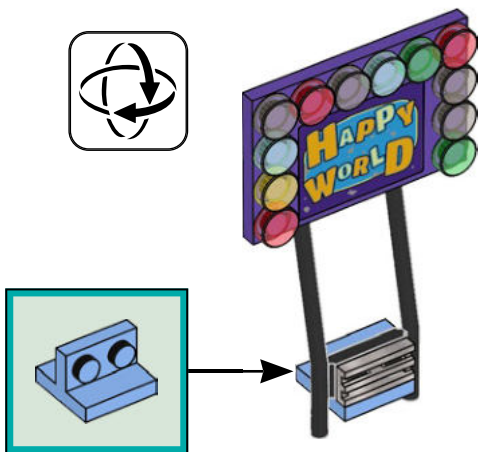
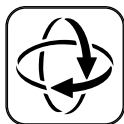

157



158

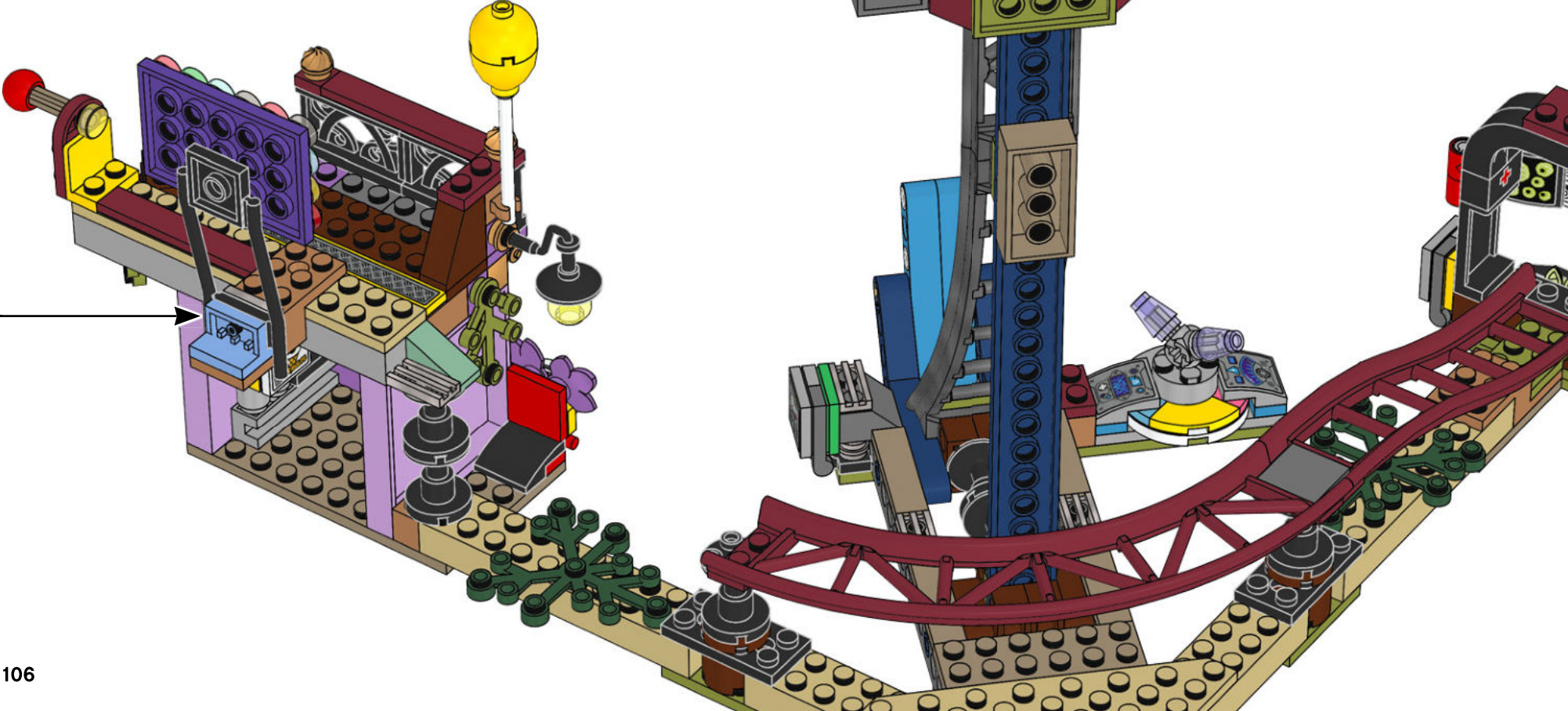

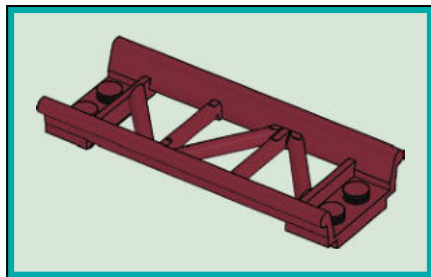
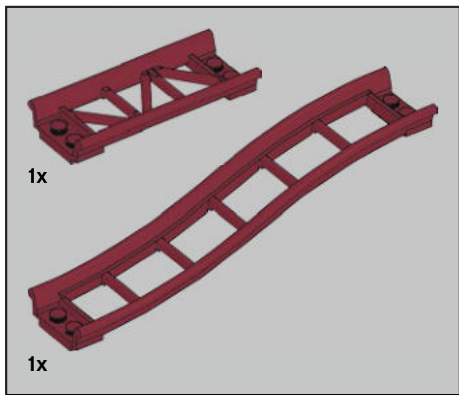

159

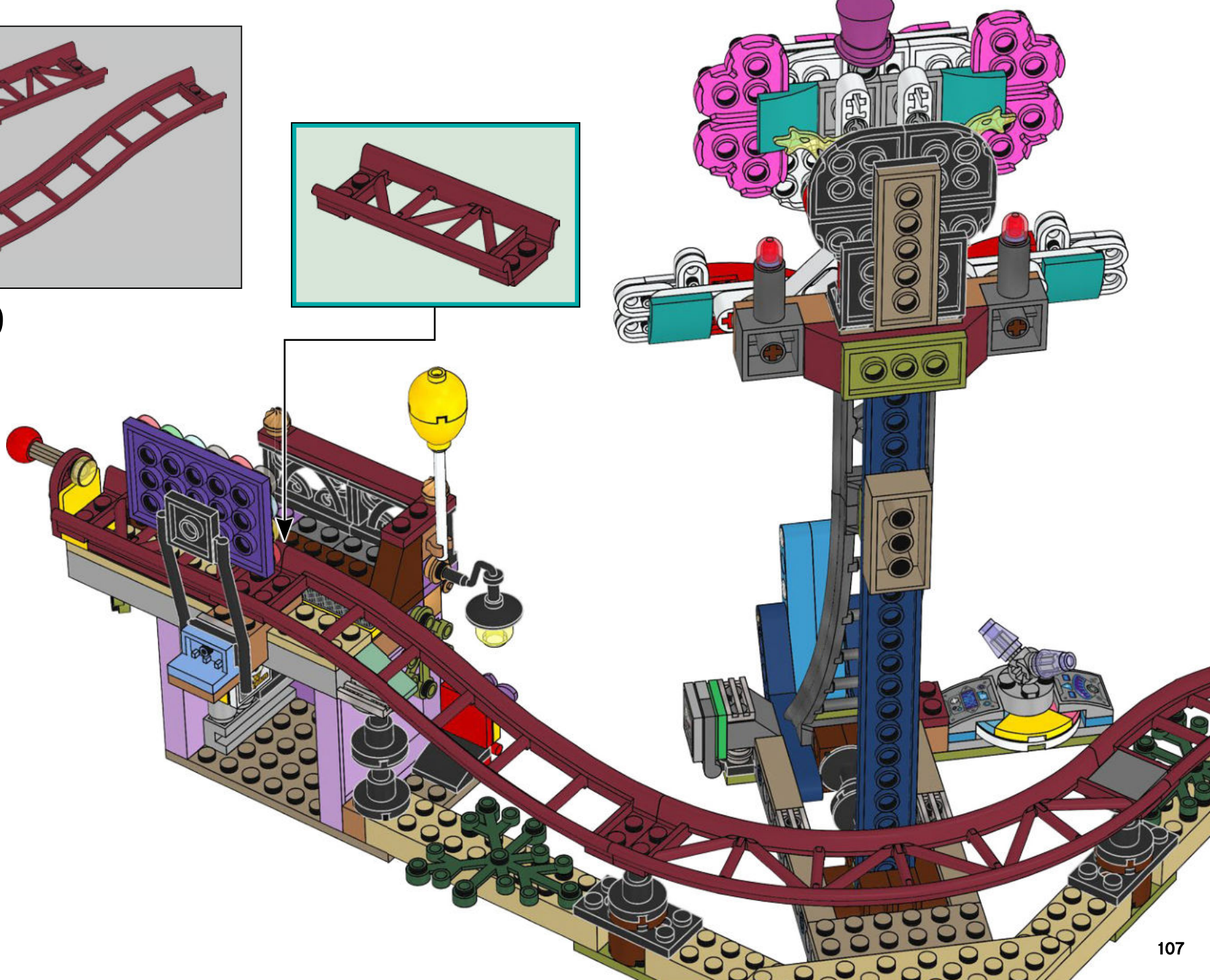

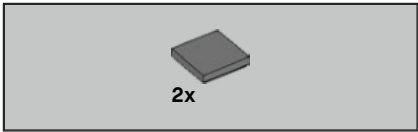

160

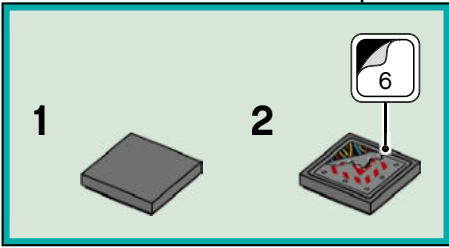
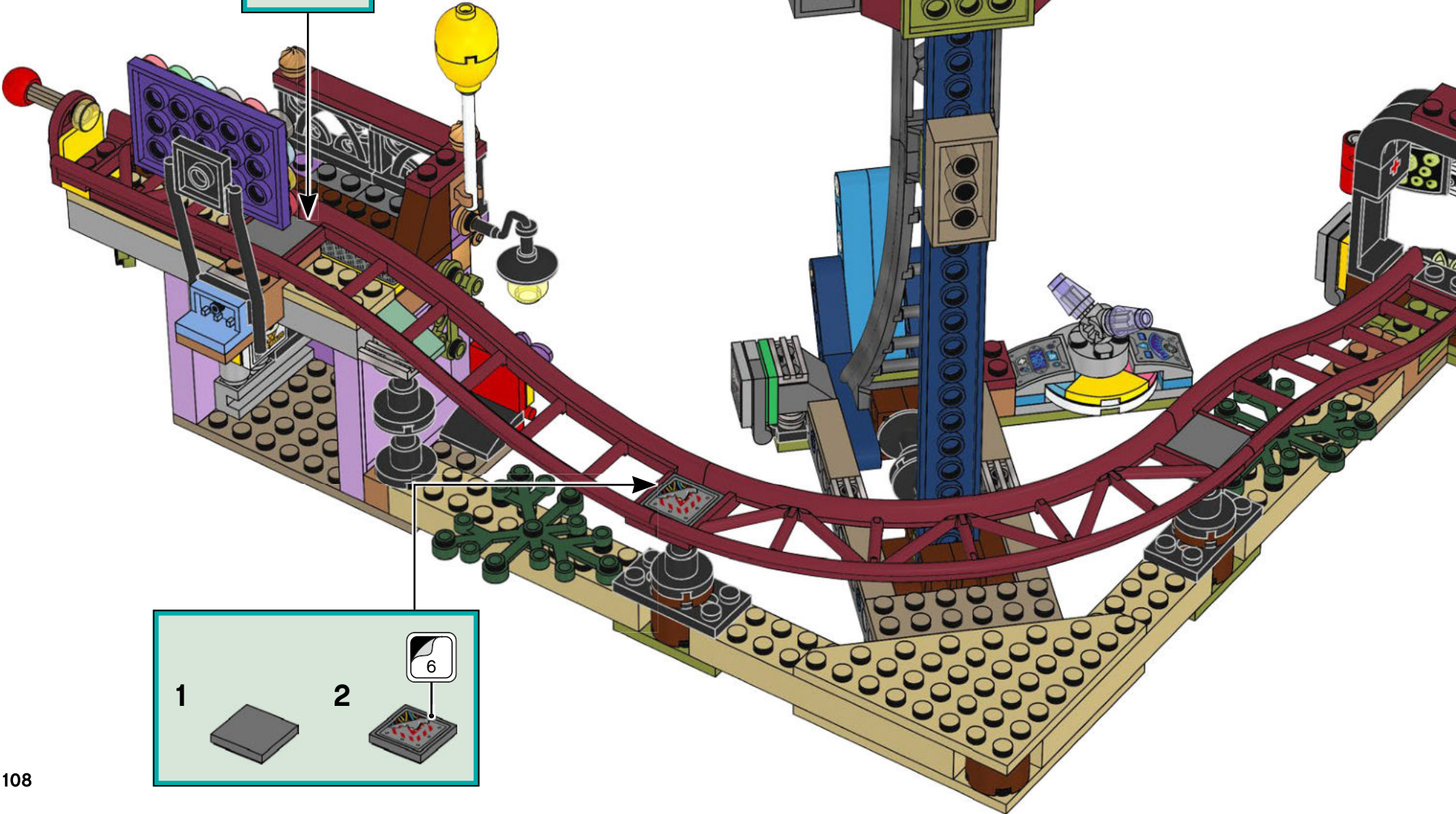

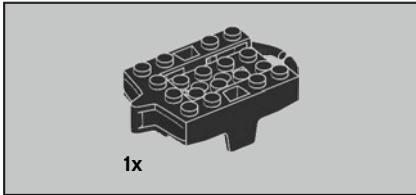

161

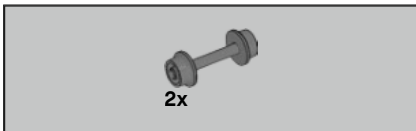
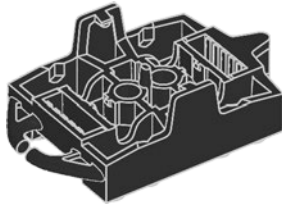

162

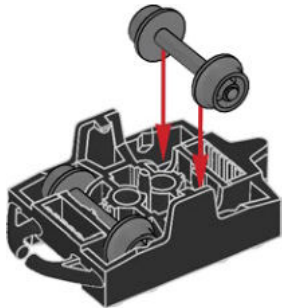

163

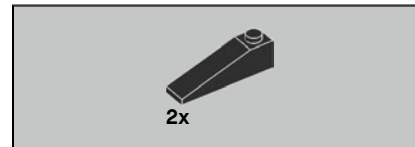
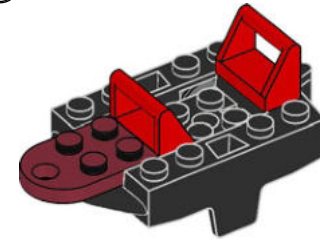

164

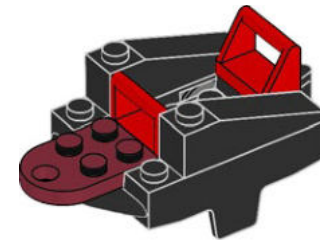



2x

# 165

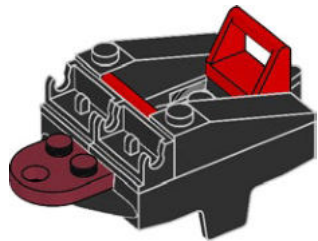

2x



1x



2x



2x

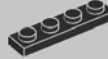

1x



1x

# 166

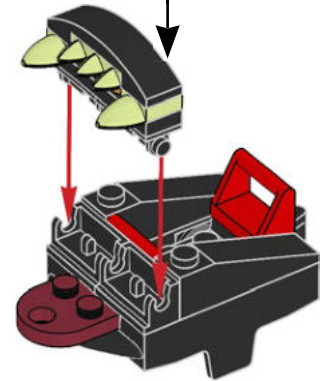
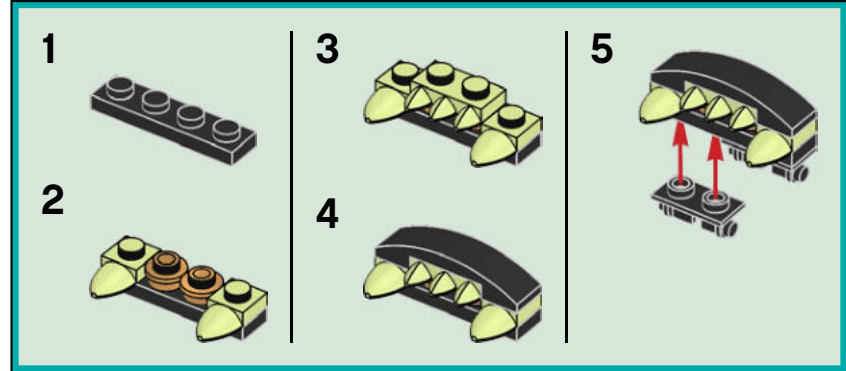

167

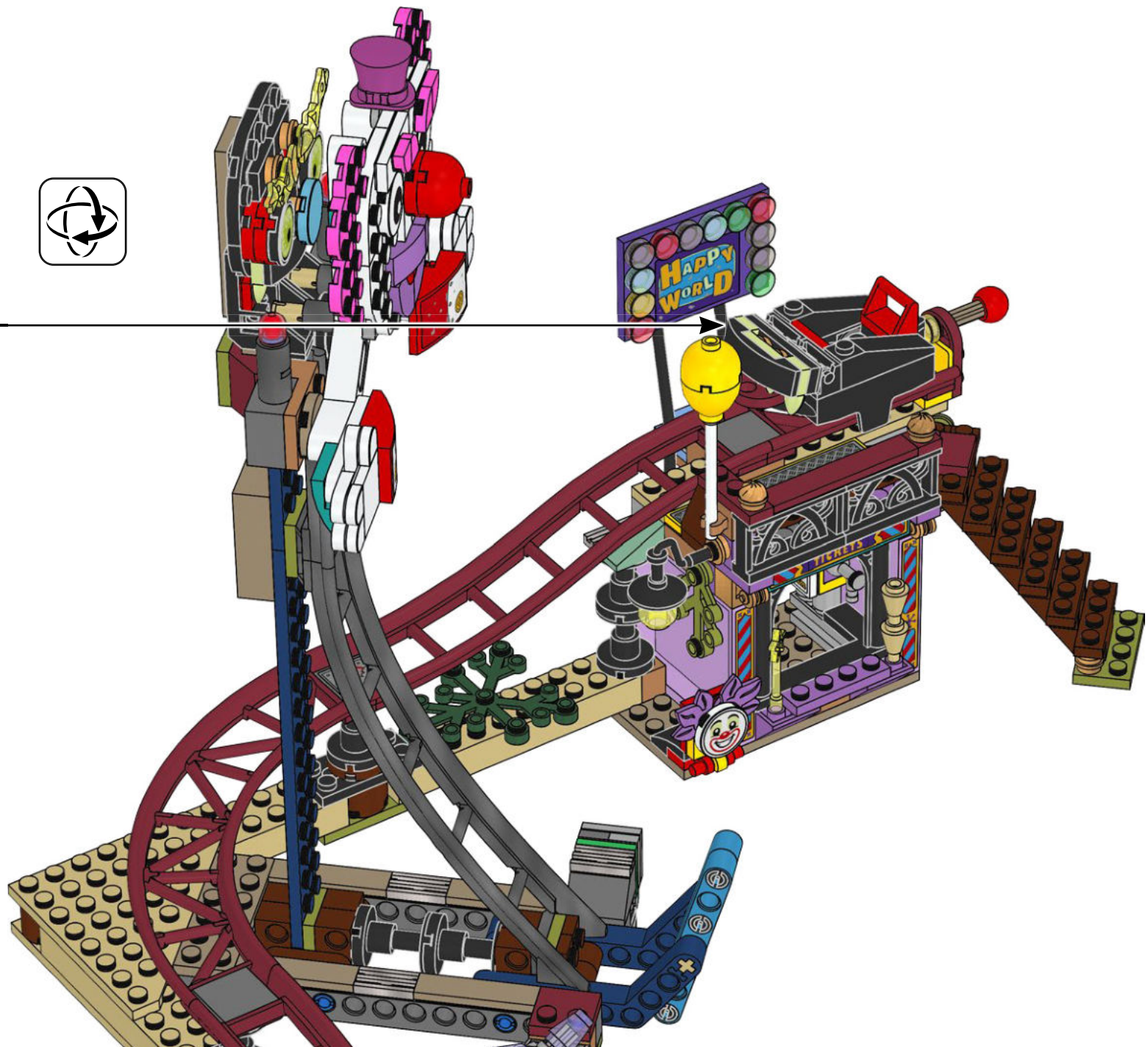





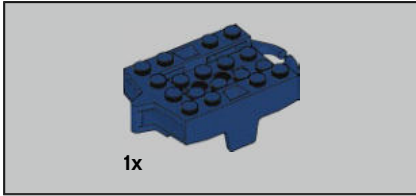

168

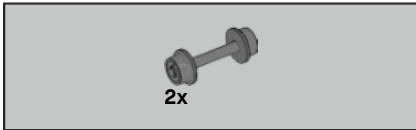
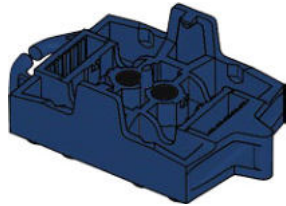

169

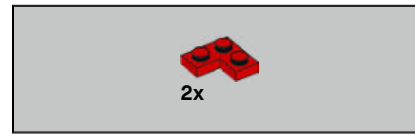
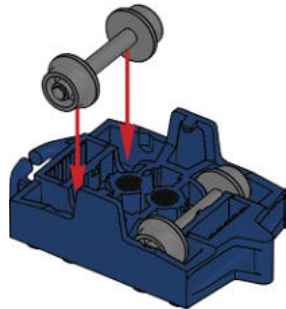

170

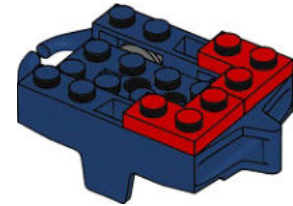
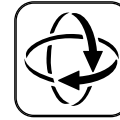

171

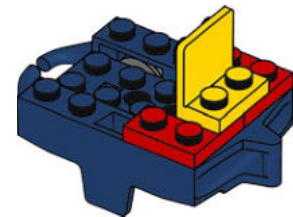



172



173

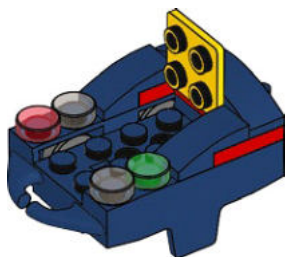

174



175

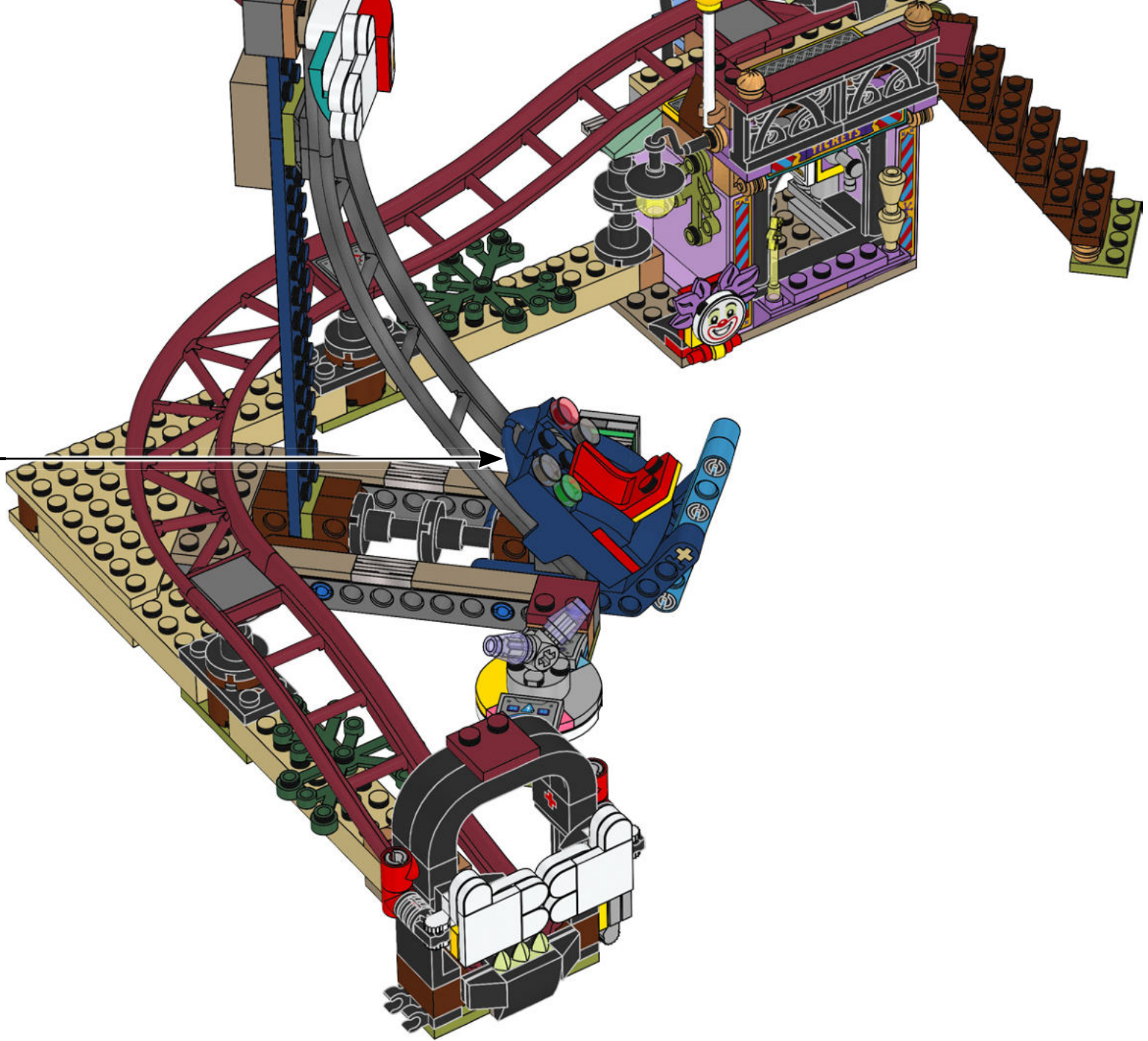

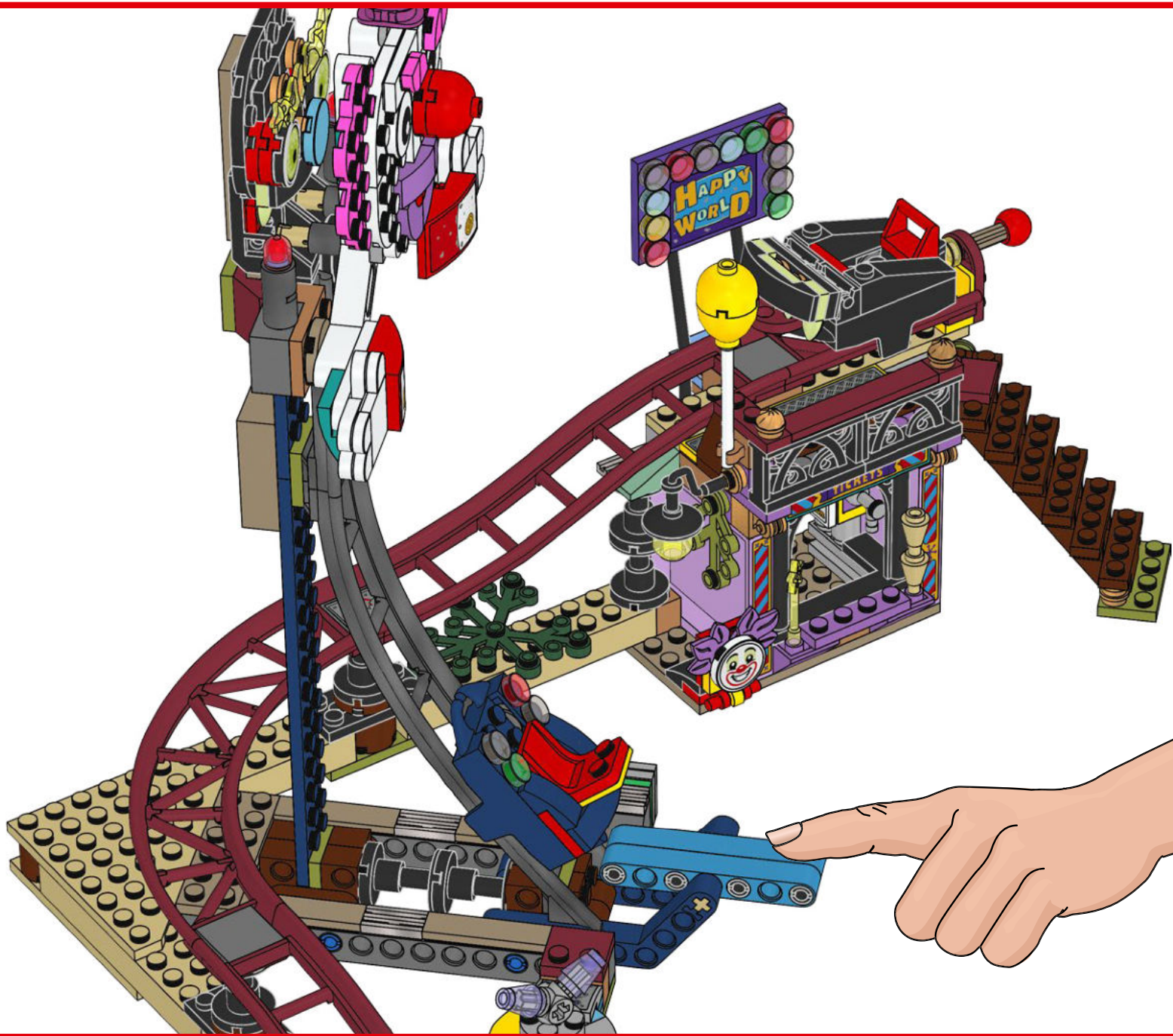

# HIDDEN SIDE



70427



70428



70429



70432



70431



70430

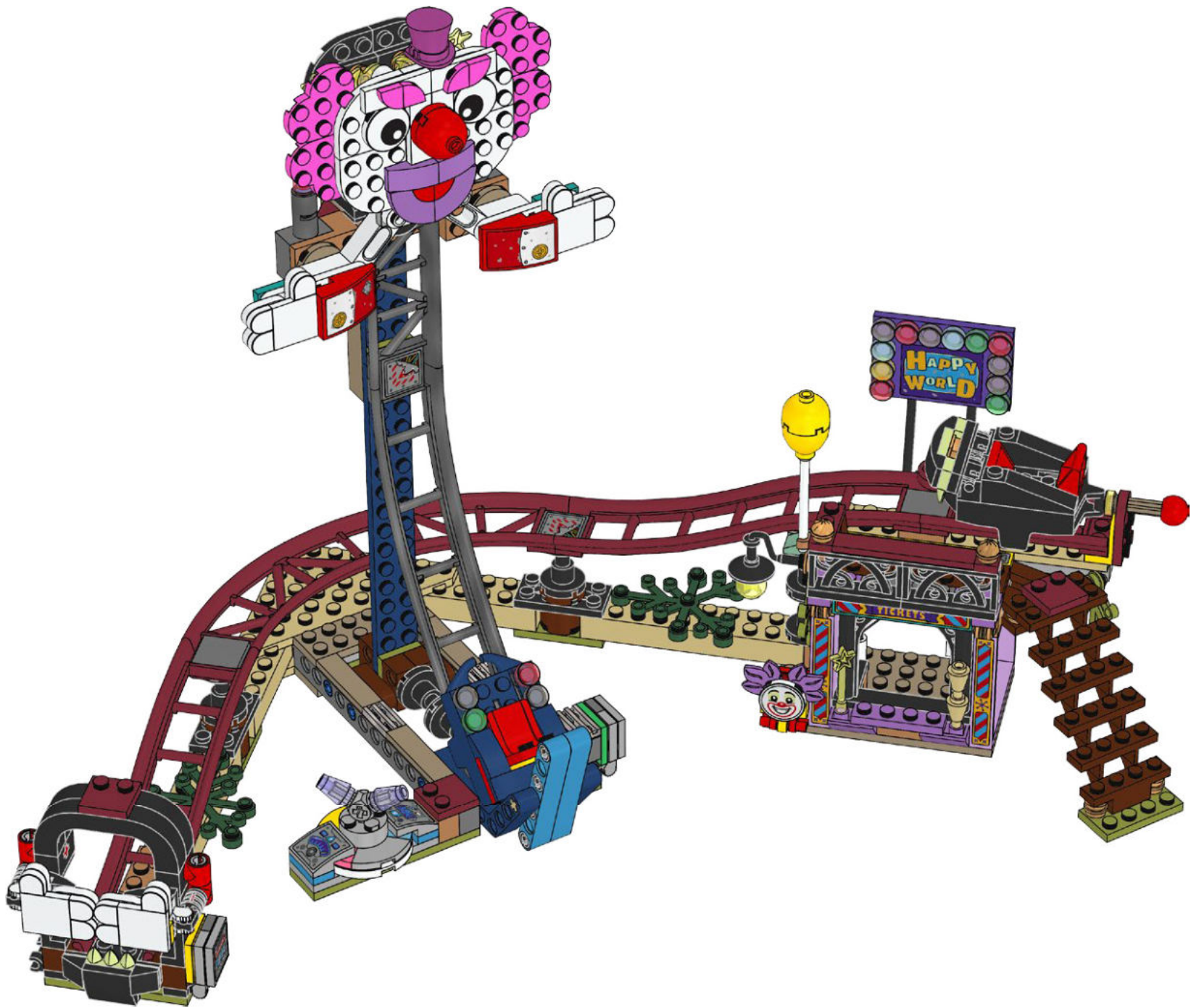



70421



70420



70419



70418



70425



70424



70423



70422





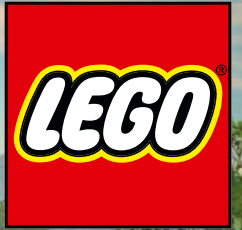

- 1x 6170419
- 1x 6234807
- 12x 6250591
- 1x 6289318
- 1x 6289331
- 14x 6210272
- 1x 6294387
- 1x 6294391
- 1x 6044691
- 2x 6060734
- 1x 6271763
- 2x 4515337
- 5x 306801
- 1x 6238334
- 3x 6195371
- 1x 4558168
- 1x 4515347
- 4x 4550745
- 2x 6280386
- 2x 366601
- 1x 6275386
- 1x 6271761
- 1x 6295084
- 1x 6295080
- 1x 6145255
- 1x 6258069
- 2x 6132790
- 3x 6250168
- 1x 4290714
- 1x 6270152
- 2x 6170390
- 2x 4142865
- 5x 403221
- 1x 4216657
- 1x 6289340
- 4x 6167939
- 8x 302321
- 2x 243221
- 1x 4140585
- 1x 6013868
- 2x 242021
- 1x 407921
- 2x 6132210
- 1x 243121
- 1x 6271742
- 1x 6275429
- 1x 6289281
- 1x 6289314
- 1x 6271729
- 4x 302424
- 1x 6145704
- 1x 4216656
- 1x 6179329
- 3x 6208753
- 1x 306824
- 1x 6275508
- 2x 6130007
- 1x 4189400
- 2x 4504382
- 2x 6192778
- 2x 4158848
- 3x 6070695
- 6x 6106280
- 1x 474026
- 4x 4121715
- 1x 6271189
- 2x 4614788
- 1x 6271133
- 3x 6092585
- 2x 393826
- 2x 6178922
- 2x 393726
- 3x 6310268
- 2x 6211476
- 2x 6053077
- 2x 6168620
- 2x 302126
- 2x 4613153
- 2x 371026
- 2x 4515362
- 2x 6138726
- 2x 6021678
- 2x 4227392
- 2x 370926
- 1x 6105963
- 2x 6132770
- 1x 6203523
- 1x 6294677
- 1x 6284697
- 2x 6211928
- 2x 4653988
- 1x 4107762
- 1x 6295081
- 1x 6289334
- 1x 6275081
- 1x 6253657
- 1x 6031821
- 4x 6175927
- 1x 4247145
- 4x 4550329
- 1x 6096215
- 2x 6094143
- 1x 6037886
- 1x 6233695
- 2x 6279908
- 1x 6027627
- 1x 6120642
- 1x 6271130
- 4x 4143005
- 8x 4514553
- 1x 6295114
- 4x 6222950
- 1x 6264986
- 2x 6017003
- 2x 4666579
- 2x 4514554
- 1x 6294678
- 1x 6093864
- 2x 4626948

4x 4633691  
 6x 4619636  
 2x 6236395  
 2x 6245501  
 2x 6050916  
 12x 6190252  
 2x 6112307  
 2x 4569385  
 4x 4569382  
 4x 6175943  
 1x 6237878  
 4x 6240462  
 4x 6254513  
 2x 6294375

4x 4211412  
 1x 4211503  
 2x 6227897  
 1x 4211526  
 2x 4211807  
 1x 4502595  
 2x 6132886  
 2x 6212077  
 6x 6276848  
 2x 6102357  
 1x 6163990  
 2x 4211804  
 1x 4211613  
 3x 4211445  
 1x 4211522

2x 4211159  
 3x 4211166  
 6x 6151461  
 1x 4629736  
 2x 6138664  
 2x 4211202  
 2x 6135494  
 2x 6121726  
 4x 6084573  
 1x 4277751  
 1x 4211211  
 1x 6240515

1x 4598531  
 2x 6294358  
 1x 6294360  
 1x 6294361  
 1x 6287321  
 2x 4211137  
 1x 6313372  
 4x 6267420  
 3x 6267421  
 2x 6266967

1x 4539114  
 3x 6214309  
 1x 4539076  
 2x 4568753  
 2x 4650865  
 1x 6175590  
 1x 6294376  
 2x 4521187  
 4x 4211055  
 1x 6063616  
 2x 6214341  
 4x 6135290  
 1x 4211054  
 2x 4211046

2x 6171762  
 4x 6258607  
 6x 6079000  
 2x 6274740  
 2x 6274739  
 3x 6274742  
 2x 4567340  
 1x 6245511  
 1x 6168672  
 1x 6289322  
 1x 6289316  
 1x 6299272  
 1x 6275078  
 1x 6250024

3x 6125776  
 2x 6210460  
 1x 6286505  
 1x 6279104  
 2x 6136331  
 2x 6199900  
 2x 4619517  
 2x 6223452  
 1x 4619524  
 2x 6249322

Customer Service

Kundenservice  
 Service Consommateurs  
 Servicio Al Consumidor

LEGO.com/service or dial

 : 00800 5346 5555  
 : 1-800-422-5346

# WIN

GO TO [WWW.LEGO.COM/PRODUCTFEEDBACK](http://WWW.LEGO.COM/PRODUCTFEEDBACK) AND GIVE US YOUR SHORT **FEEDBACK** ABOUT THIS LEGO® SET FOR A CHANCE TO WIN A COOL LEGO PRIZE.

Terms & Conditions apply

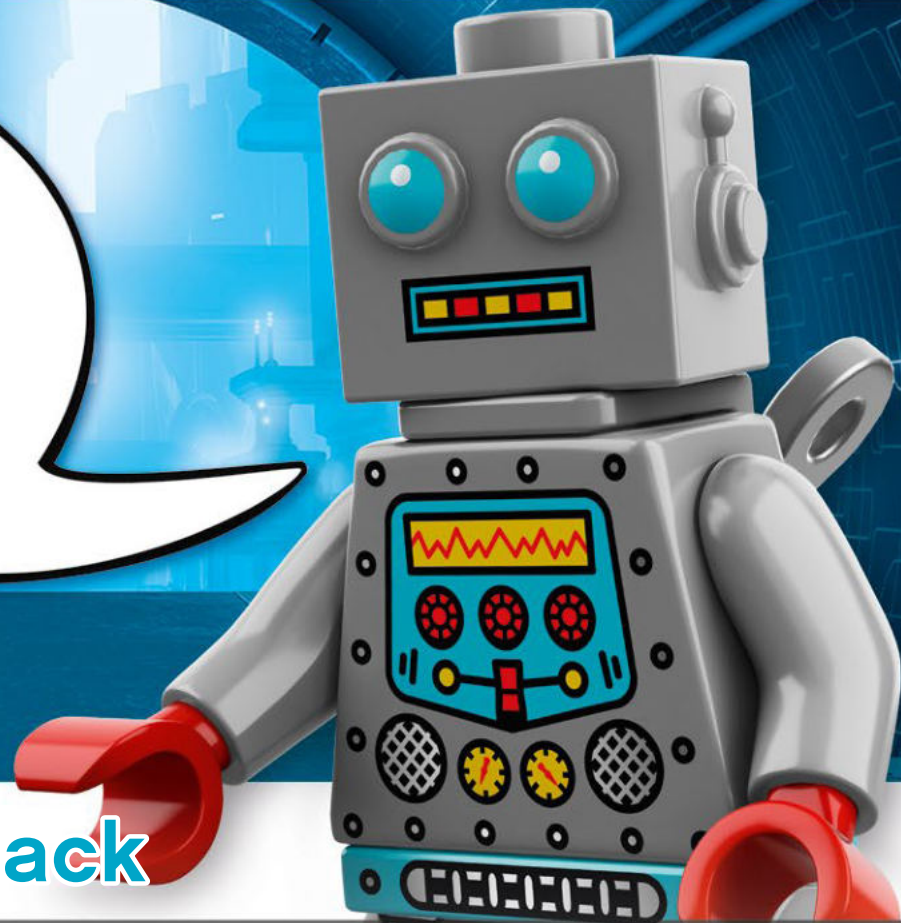

## [LEGO.com/productfeedback](http://LEGO.com/productfeedback)

### GEWINNE

Erzähle uns auf [www.LEGO.com/productfeedback](http://www.LEGO.com/productfeedback)

etwas über die Erfahrungen, die du mit diesem LEGO® Set gemacht hast, und sichere dir die Chance auf einen coolen LEGO Preis!

Es gelten die Teilnahmebedingungen

### GAGNE

Rends-toi sur [www.LEGO.com/productfeedback](http://www.LEGO.com/productfeedback)

et donne-nous quelques commentaires sur ce produit LEGO® pour avoir une chance de gagner un prix LEGO !

Voir Conditions Générales

### GANANA

Visita [www.LEGO.com/productfeedback](http://www.LEGO.com/productfeedback)

y envíanos tu opinión acerca de este set LEGO®. ¡Participarás en el sorteo de un premio LEGO!

Términos y Condiciones aplicables

### 获取奖品

登录 [www.LEGO.com/productfeedback](http://www.LEGO.com/productfeedback)

给出关于此乐高®套装的简短反馈，就有机会获得炫酷乐高奖品

《条款及条件》适用

### 경품 당첨 기회

[www.LEGO.com/productfeedback](http://www.LEGO.com/productfeedback)

페이지로 이동하여 이 레고® 세트에 대한 간단한 피드백을 보내 주시고 멋진 레고 경품을 탈 수 있는 기회도 잡으십시오

약관 적용

### ЗАПОЛНИ АНКЕТУ И ПОЛУЧИ ПРИЗ

Перейди по ссылке [www.LEGO.com/productfeedback](http://www.LEGO.com/productfeedback)

ответь всего на несколько вопросов об этом наборе LEGO®, и у тебя появится шанс выиграть твой любимый приз от компании LEGO.

Применяются Условия и правила участия